

Intended for
Statoil – Utsira high power hub project

Document type
Report

Document Number
131609005-ROGN-S-RA-10001 rev 01

Date
August, 2013

UTSIRA HIGH POWER HUB EMF STUDY

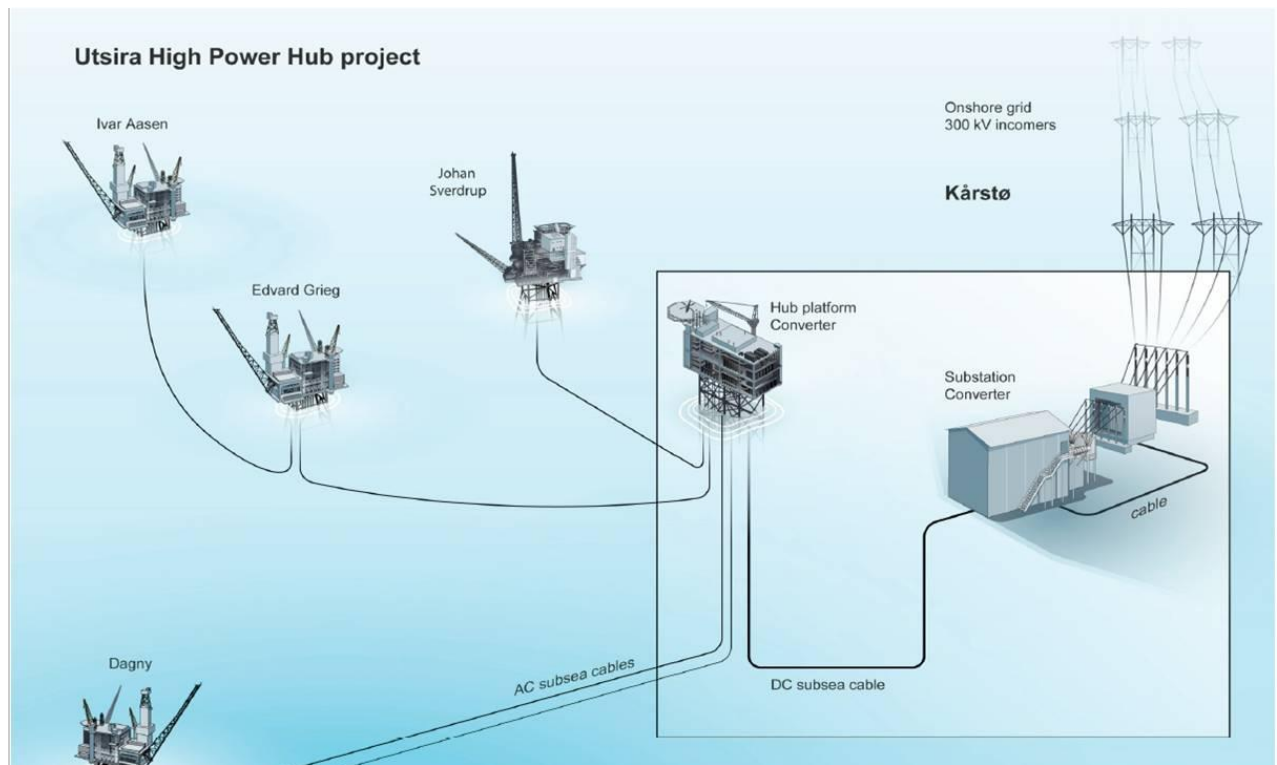

UTSIRA HIGH POWER HUB EMF STUDY

Revision **02**
Rev. Status **Issued for Information**
Date **27 August 2013**
Made by **Elain Svindland Stenberg; Kristian Stray; Alan Gundersen Mecham; Farhad Pakshad**
Checked by **Kristian Stray; Farhad Pakshad**
Approved by **Farhad Pakshad**

Ref 131609005-ROGN-S-RA-10001

TABLE OF CONTENT

1.	Purpose and scope	10
2.	Summary and conclusions	12
2.1	Human exposure risk by ELF / Static EMF	12
2.1.1	HV DC and AC current - onshore substation	14
2.1.2	HV DC and AC current - Utsira HPH	16
2.1.3	HV AC current - bridge between Utsira HPH and Johan Sverdrup LQ platform	17
2.1.4	HV AC current - Johan Sverdrup	17
2.2	Effect of static magnetic field on compass performance	18
2.3	Marine environment exposure risk by static EMF	18
2.4	General risk reduction measures	19
2.4.1	Human exposure	19
2.4.2	Marine environment exposure	19
3.	Abbreviations	20
4.	References	21
5.	Introduction	23
5.1	General aspects of offshore electrification from shore	23
5.1.1	Available technologies	23
5.1.2	HV Cables	25
5.1.3	HV Transformers and switchgears	25
5.2	General aspects of physics behind formation of electromagnetic field	25
5.2.1	Electromagnetic spectrum	25
5.2.2	Direct and alternating currents	28
5.3	General risk aspects of human exposure to magnetic field and the defined thresholds	28
5.3.1	Time varying magnetic field	28
5.3.2	Risk of cancer	29
5.3.3	Basic restrictions and reference levels	29
5.3.4	Company's requirement	31
5.3.5	Norwegian radiation protection authority's threshold and investigation levels	31
5.3.6	Typical exposure from home appliances and magnetic field distance dependency	32
5.3.7	Limits of exposure to static magnetic fields	33
5.4	General risk aspects of marine environment exposure to EMF	33
5.4.1	Electrosensitive species	34
5.4.2	34	
5.4.3	Sensitivity levels towards magnetic- and iE-fields	35
6.	EMF calculations	36
6.1	Terms and principles of magnetic fields	36
6.1.1	The magnetic field	36

6.1.2	Calculating magnetic fields	36
6.1.3	Calculating compass deviation	37
6.1.4	General assumptions for calculations	37
6.2	DC magnetic field results	38
6.2.1	Main assumptions and comments	38
6.2.2	Onshore AC/DC Converter station Haugsneset	38
6.2.3	AC/DC Converter station to seabed	39
6.2.4	HVDC sea cable	40
6.2.5	Cable riser to Utsira UHPH DC/AC converter	44
6.3	Compass deviation (declination)	44
6.3.1	Main assumptions and comments	44
6.3.2	Results	44
6.4	AC magnetic fields	47
6.4.1	Main assumptions	47
6.4.2	AC supply Haugsneset	47
6.4.3	AC supply UHPH	49
6.4.4	Utsira UHPH 33 kV offshore	52
6.4.5	Johan Sverdrup 33 kV	54
6.5	Electrical equipment as sources of magnetic field	56
6.5.1	General considerations	56
6.5.2	Transformer example	56
7.	Assessment of human exposure risk	59
7.1	Introduction	59
7.1.1	Exposure definition	59
7.1.2	Scope of exposure assessment	59
7.1.3	Exposure and exposure assessment of electrical power magnetic field	60
7.2	Exposure assessment of HV AC/DC onshore conversion substation and landfall	60
7.2.1	Description of area:	60
7.2.2	Planned safety barriers	62
7.2.3	Operation, inspection and maintenance	63
7.2.4	Exposure time	63
7.2.5	Estimated magnetic flux intensity and exposure	64
7.3	Utsira High Power Hub platform	66
7.3.1	Description of area:	66
7.3.2	Planned safety barriers	67
7.3.3	Operation, inspection and maintenance	67
7.3.4	Exposure time	68
7.3.5	Estimated magnetic flux intensity and exposure	68
7.4	Bridge between Utsira HPH and Johan Sverdrup	71
7.4.1	Description of area	71
7.4.2	Planned safety barriers	71
7.4.3	Operation, inspection and maintenance	71
7.4.4	Exposure time	71
7.4.5	Estimated magnetic flux intensity and exposure	72
7.5	Johan Sverdrup connection point	73
7.5.1	Description of area	73
7.5.2	Planned safety barriers	74
7.5.3	Operation, inspection and maintenance	74
7.5.4	Exposure time	74
7.5.5	Estimated magnetic flux intensity and exposure	74
8.	Assessment of marine environment exposure risk	75
8.1	The marine environment in the project area	75

8.2	Identified areas relevant for exposure to EMFs	76
8.2.1	DC sea cable to the hub (Utsira)	76
8.3	Assessment of EMF impacts from DC cables to the marine environment	78
8.3.1	Potential effects	79
8.3.2	Evaluation of EMF results	80
9.	Risk reduction measures	83
9.1	General	83
9.2	Human exposure	83
9.3	Marine environment exposure	83
10.	Recommend scope for follow up EMF study	84

TABLE OF FIGURES

FIGURE 1.1 – FUNCTIONAL BLOCK DIAGRAM OF UTSIRA HPH POWER TRANSMISSION	10
FIGURE 1.2 - OVERALL CABLE LAYOUT, (REF. 17).....	11
FIGURE 5.1 - HVDC LIGHT BUILDING BLOCKS /20/	24
FIGURE 5.2 - HVDC LIGHT SUBSTATION LAYOUT /24/	24
FIGURE 5.3 - HVDC CABLES USED SUBSEA OFFSHORE /21/.....	25
FIGURE 5.4 - THE ELECTROMAGNETIC SPECTRUM (FIGURE 2.2 IN REF. /10/)	26
FIGURE 5.5 AN ELECTROMAGNETIC WAVE IS A SPECIAL SOLUTION OF MAXWELL'S EQUATIONS. THE SOLUTION APPLIES PRIMARILY FOR THE EMPTY SPACE (OR FOR PURELY HOMOGENEOUS MEDIA) (FIGURE 2.1 IN REF. /10/)	27
FIGURE 5.6 ELECTRIC AND MAGNETIC FIELD FROM AN INFINITELY LONG STRAIGHT CONDUCTOR RUNS PARALLEL OVER AN INFINITE LEVEL WITH INFINITE THICKNESS (EARTH). FIELD LINES ARE ALSO SHOWN. (FIGURE 2.3 IN REF. /10/)	27
FIGURE 5.7 - EXAMPLES OF SOURCES AND MEASURED VALUES FOR LOW FREQUENCY MAGNETIC FIELD (REF. /10/)	32
FIGURE 6.1 - MAGNETIC FIELD FROM A LONG STRAIGHT WIRE WHERE THE CURRENT DIRECTION IS HEADING OUT OF THE SHEET /36/	36
FIGURE 6.2 - BASIC ELEMENTS CONSIDERED FOR COMPASS DEVIATION ASSESSMENT	37
FIGURE 6.3 - MAGNETIC FIELD FROM HVDC CABLES AT THE CONVERTER STATION ONSHORE, NORMAL OPERATION	38
FIGURE 6.4 - MAGNETIC FIELD FROM HVDC CABLES AT THE CONVERTER STATION ONSHORE, FAULT CONDITION	39
FIGURE 6.5 MAGNETIC FIELD FROM ONE HVDC CABLE AT THE CONVERTER STATION ONSHORE, NORMAL AND FAULT CONDITION.....	39
FIGURE 6.6 - MAGNETIC FIELD FROM HVDC CABLES FROM CONVERTER STATION TO SEABED	40
FIGURE 6.7 - EMF DEVELOPMENT, 1 M ABOVE THE DC CABLES DURING NORMAL OPERATION AND FAULT MODE WITH 3 METER DISTANCE BETWEEN THE TWO CABLES	41
FIGURE 6.8 - EMF DEVELOPMENT AT DIFFERENT VERTICAL DEPTHS ABOVE DC CABLES	41
FIGURE 6.9 - EMF DEVELOPMENT, 1 M ABOVE THE DC CABLES DURING OPERATION WITH 20 METER DISTANCE BETWEEN THE TWO CABLES	42
FIGURE 6.10 - EMF DEVELOPMENT FROM THE DC CABLES DURING FAULT MODE WITH 20 M DISTANCE BETWEEN THE TWO CABLES.....	42
FIGURE 6.11 - EMF DEVELOPMENT FROM THE DC CABLES DURING OPERATION AND FAULT MODE WITH 100 M DISTANCE BETWEEN THE CABLES.....	43
FIGURE 6.12 - EMF DEVELOPMENT THE DC CABLES DURING OPERATION WITH 1000 M DISTANCE BETWEEN THE CABLES	43
FIGURE 6.13 - EMF DEVELOPMENT FROM THE DC CABLES DURING OPERATION WITH 4000 M DISTANCE BETWEEN THE CABLES	44
FIGURE 6.14 - COMPASS DEVIATION FOR THE FIRST ~1000 M FROM SHORE DURING NORMAL OPERATION	45
FIGURE 6.15 - COMPASS DEVIATION FOR THE FIRST ~1000 M FROM SHORE IF FAULT ON ONE TRAIN.	45
FIGURE 6.16 - COMPASS DEVIATION FOR ~1000-3000 M FROM SHORE IN NORMAL OPERATION.....	45
FIGURE 6.17 - COMPASS DEVIATION FOR ~3000-4000 M FROM SHORE IN NORMAL OPERATION.....	46
FIGURE 6.18 - COMPASS DEVIATION FOR ~4000-7000 M FROM SHORE IN NORMAL OPERATION.....	46

FIGURE 6.19 - COMPASS DEVIATION FROM ~7000 M FROM SHORE TO CLOSE TO UHPH IN NORMAL OPERATION	46
FIGURE 6.20 - COMPASS DEVIATION AT UHPH APPROACH IN NORMAL OPERATION	47
FIGURE 6.21 - COMPASS DEVIATION DURING FAULT CONDITIONS IF CABLES ARE LAID NORTH-SOUTH.....	47
6.22 - PHASE ORIENTATION AC CABLES IN TREFOIL AND FLAT FORMATION	47
FIGURE 6.23 - AC SUPPLY TO POWER TRANSFORMER AT CONVERTER STATION ONSHORE, NORMAL OPERATION	48
FIGURE 6.24 - AC SUPPLY TO POWER TRANSFORMER AT CONVERTER STATION ONSHORE, FAULT CONDITION.....	48
FIGURE 6.25 - AC SUPPLY FROM POWER TRANSFORMER AT CONVERTER STATION ONSHORE, CABLES IN TREFOIL, NORMAL OPERATION	48
FIGURE 6.26 - AC SUPPLY FROM POWER TRANSFORMER AT CONVERTER STATION ONSHORE, CABLES IN TREFOIL, FAULT CONDITION.....	49
FIGURE 6.27 - AC POWER TRANSFORMER BUSHING, CONVERTER STATION ONSHORE, NORMAL OPERATION	49
FIGURE 6.28 - AC POWER TRANSFORMER BUSHING, CONVERTER STATION ONSHORE, FAULT CONDITION.....	49
FIGURE 6.29 - UHPH AC POWER TRANSFORMER BUSHING, NORMAL OPERATION	50
FIGURE 6.30 - UHPH AC POWER TRANSFORMER BUSHING, FAULT CONDITION....	50
FIGURE 6.31 - UHPH AC SUPPLY FROM DC VALVES, CABLES IN TREFOIL, NORMAL OPERATION.....	51
FIGURE 6.32 - UHPH AC SUPPLY FROM DC VALVES, CABLES IN TREFOIL, NORMAL OPERATION.....	51
FIGURE 6.33 - PRELIMINARY CROSS SECTION DRAWING OF BRIDGE TO JOHAN LQ PLATFORM /34/	52
FIGURE 6.34 - 33 kV AC CABLE LAYOUT AND CURRENT FLOW UHPH AND BRIDGE	53
FIGURE 6.35 - MAGNETIC FIELD DISTRIBUTION FROM 33 kV AC CABLES AT UHPH AND BRIDGE	53
FIGURE 6.36 - 33 kV AC CABLE GIS TERMINATION UHPH	53
FIGURE 6.37 - MAGNETIC FIELD DISTRIBUTION 33 kV GIS AT UHPH	54
FIGURE 6.38 - 33 kV AC CABLE LAYOUT AND CURRENT FLOW	54
FIGURE 6.39 - MAGNETIC FIELD DISTRIBUTION FROM 33 kV AC CABLES AT JOHAN SVERDRUP	55
FIGURE 6.40 - 33 kV AC CABLE GIS TERMINATION JOHAN SVERDRUP	55
FIGURE 6.41 - MAGNETIC FIELD DISTRIBUTION 33 kV GIS AT JOHAN SVERDRUP	56
FIGURE 6.42 - TOP VIEW OF 250 MVA TRANSFORMER AND FIELD STRENGTH MEASUREMENT POINTS /35/.....	57
FIGURE 6.43 - CALCULATED AND MEASURED MAGNETIC FIELD FOR 250 MVA 300 kV TRANSFORMER /35/	57
FIGURE 6.44 - TOP VIEW OF 220 MVA TRANSFORMER AND FIELD STRENGTH MEASUREMENT POINTS /35/.....	57
FIGURE 6.45 - CALCULATED MAGNETIC FIELD FOR 220 MVA 240kV TRANSFORMER /35/	58
FIGURE 7.1 - AC/DC CONVERTER STATION AREA (REF. 27/)	60
FIGURE 7.2 - 3D VIEW OF CONVERSION SUBSTATION.....	61
FIGURE 7.3 - CONVERSION TRAIN BUILDING – PLAN LEVEL 1 (REF. /29/).....	61
FIGURE 7.4 - CONVERSION TRAIN BUILDING – PLAN LEVEL 2 (REF. /30/).....	62
FIGURE 7.5 - ONSHORE CONVERSION SUBSTATION (REF. /38/)	62
FIGURE 7.6 - ELEVATION: 500000, MAIN DECK (REF. /31/)	66
FIGURE 7.7 - ELEVATION 508000, LOWER AC-HALL DECK (REF. /32/).....	66
FIGURE 7.8 - ELEVATION: 517400, CENTRE DECK (REF. /33/).....	67

FIGURE 7.9 - ELEVATION: 525300, UPPER AC HALL DECK.....	67
FIGURE 7.10 - PRELIMINARY CROSS SECTION DRAWING OF BRIDGE TO JOHAN LQ PLATFORM /34/	71
FIGURE 7.11 - JOHAN SVERDRUP LQ, CELLAR DECK, REF. /39/	73
FIGURE 7.12 - JOHAN SVERDRUP LQ, MAIN DECK, REF. /40/	73

TABLE OF TABLES

TABLE 5.1 - TECHNOLOGY SELECTION FOR OFFSHORE POWER CONSUMPTION	23
TABLE 5.2 - RELEVANT MECHANISMS OF INTERACTION, ADVERSE EFFECTS, BIOLOGICALLY EFFECTIVE PHYSICAL QUANTITIES (DOSIMETRIC QUANTITIES) AND REFERENCE LEVELS FOR ELF EMF, REF. /25/	29
TABLE 5.3 - BASIC RESTRICTIONS FOR TIME VARYING ELECTRIC AND MAGNETIC FIELDS FOR FREQUENCIES UP TO 10 GHZ, REF. /7/	30
TABLE 5.4 - REFERENCE LEVELS FOR OCCUPATIONAL EXPOSURE TO TIME-VARYING ELECTRIC AND MAGNETIC FIELDS, REF. /7/.....	30
TABLE 5.5 - REFERENCE LEVELS FOR GENERAL PUBLIC EXPOSURE TO TIME-VARYING ELECTRIC AND MAGNETIC FIELDS, REF. /7/.....	31
TABLE 7.1 - DC CABLES INSIDE AND OUTSIDE SUBSTATION FENCED AREA	64
TABLE 7.2 - AC CABLES TO TRANSFORMERS	64
TABLE 7.3 - TRANSFORMERS BUSHINGS	65
TABLE 7.4 - AC CABLES FROM TRANSFORMERS TO CONVERTERS.....	65
TABLE 7.5 - DC CABLES, RISER, HANG-OFF AREA, DC CABLE ROUTE TO CONVERTERS.....	68
TABLE 7.6 - AC CABLES FROM DC/AC CONVERTER TO AC TRANSFORMERS	68
TABLE 7.7 - TRANSFORMERS BUSHINGS	69
TABLE 7.8 - HV AC CABLE GIS TERMINATION UHPH	69
TABLE 7.9 - AC CABLES ON BRIDGE	72
TABLE 7.10 - HV AC CABLES ON JOHAN SVERDRUP PLATFORMS	74
TABLE 7.11 - HV AC CABLE GIS TERMINATION JOHAN SVERDRUP	74
TABLE 8.1 - CROSSINGS ASSOCIATED WITH DC1 CABLE AND DC2 CABLE	78

1. PURPOSE AND SCOPE

In June 2013, Ramboll was awarded by Statoil to perform a coarse risk analysis of Utsira High Power Hub (UHPH) power transmission to determine exposure risk related to generated Electro-magnetic Fields (EMF) from high voltage power transmission to Utsira offshore field. The scope included both human as well as environmental exposure risk from AC and DC power. The purpose of this document is to outline the evaluations and results from the study.

The scope of study covers the following main items as shown in the Functional Block Diagram (FBD) below:

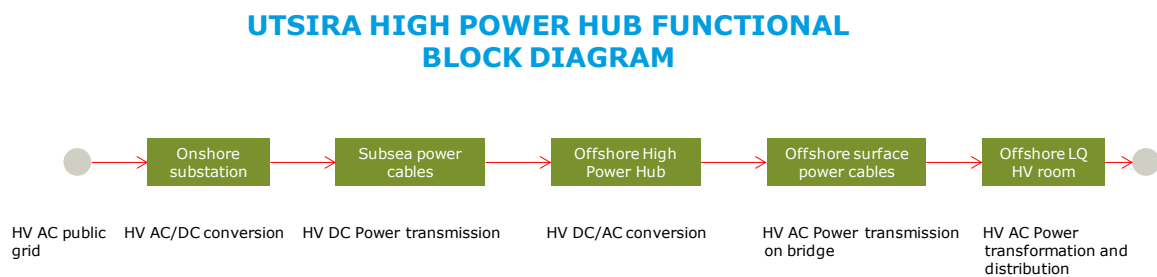

Figure 1.1 – Functional Block Diagram of Utsira HPH power transmission

The above FBD shows part of the planned design for electrification of the Dagny, Draupne (now renamed to Ivar Aasen), Edvard Grieg and Johan Sverdrup production platforms via a Normally Not Manned (NNM) platform, the Utsira High Power Hub (UHPH).

In this plan Kårstø is the recommended tie-in point for the HV AC power grid on land. Onshore HV AC/DC conversion substation is located in Haugsneset about 2 km east the Kårstø industry area. From this substation DC cables are routed to NNM UHPH for DC/AC conversion and transmission of HV AC power to Johan Sverdrup platform via a 120 m bridge.

Figure 1-2 next page shows the overall cable layout from shore to offshore facilities. (ref. /17/)

According to Contract, ref. /2/, this study has to provide the following results:

1. Identify areas relevant for exposure to electromagnetic fields and calculate EMF levels
2. Evaluate expected level of risk exposure for identified areas and variations
3. Recommendations if required for changes in concept design to ensure acceptable EMF exposure rates
4. Recommend scope for follow up EMF study if required for Utsira High Power Hub and Johan Sverdrup Field Centre

Figure 1.2 - Overall cable layout, (ref. 17)

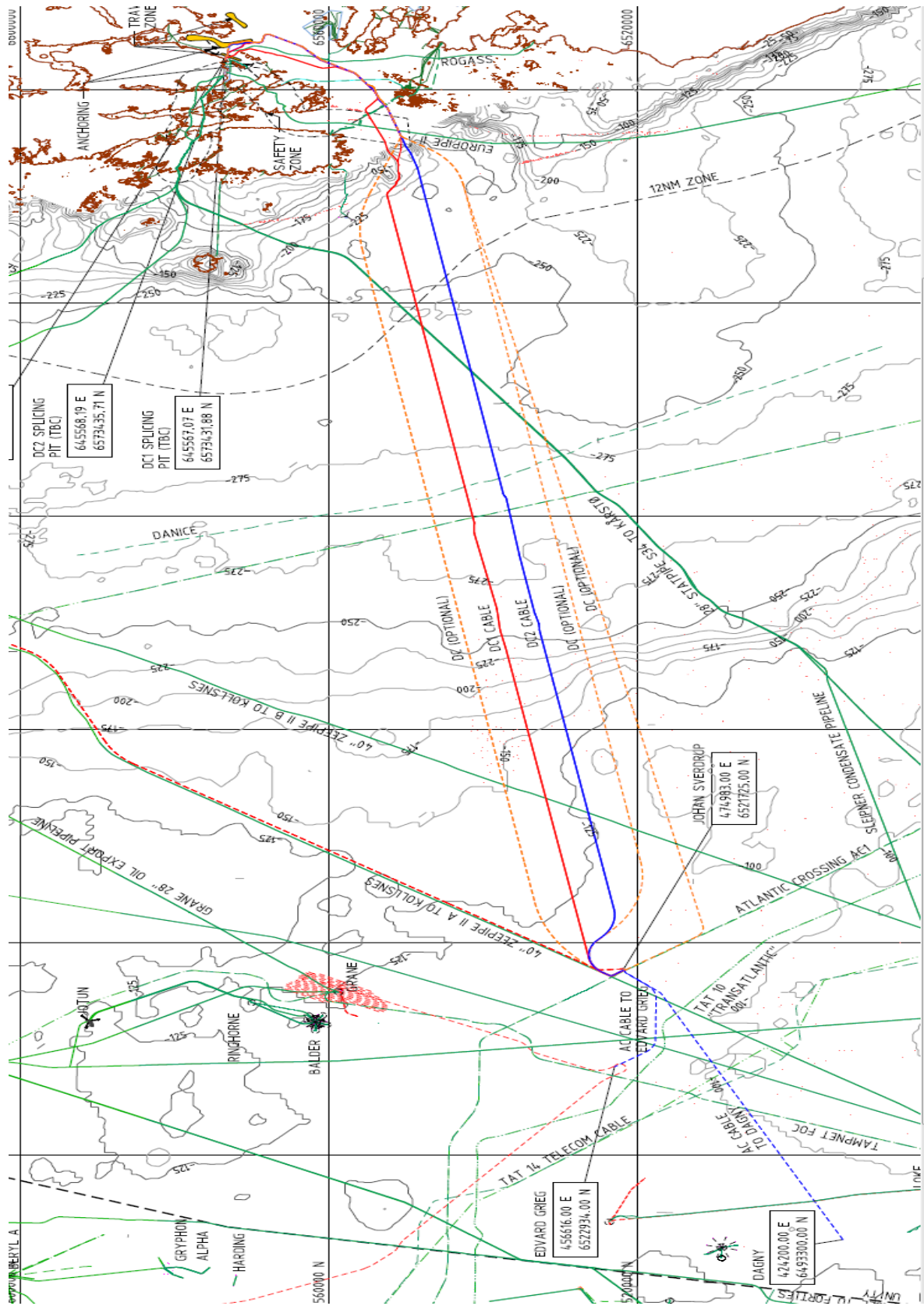

2. SUMMARY AND CONCLUSIONS

In June 2013, Ramboll was awarded by Statoil to perform a coarse risk analysis of Utsira High Power Hub (UHPH) power transmission to determine exposure risk related to generated Electro-magnetic Fields (EMF) from high voltage power transmission to Utsira offshore field. The scope included both human as well as environmental exposure risk from AC and DC power.

During the first two weeks, Ramboll arranged the kick-off meeting as well as a workshop to facilitate the execution of the study. A couple of phone meetings were also arranged between electrical engineers to clarify the input data needed for EMF calculations. (Appendix 1)

The study started with a thorough review of available project documentations and search and study of reliable sources accessible from various sources as listed in reference chapter.

2.1 Human exposure risk by ELF / Static EMF

Evaluations carried out to assess the exposure of personnel as well as general public have been documented in chapter 7. In general protection of human against dangerous agents is achieved by providing exposure or dose limits for each particular agent. The limits are defined by the health thresholds where resulted biological effects initiate health detriment. The goal is to keep the exposures below such thresholds. In addition precautionary and ALARP (as low as reasonably practicable) measures can be adopted to provide further risk reduction and higher protection against hazards.

Requirements given in ICNIRP, Company's TR0926 and NRPA constitute the basis for EMF evaluations in this study. The main focus of this study is the effect of magnetic field on human and environment since electric field can be easily shielded.

Following diagram is an attempt to depict the ALARP principle in this study and relates the exposure time to the magnetic field flux density. The diagram is based on an assumption that any exposure below $0.4 \mu\text{T}$ is time independent, i.e., there are no restriction health-wise on how long one may stay in such area. Thus the line is parallel with x-axis. ALARP region is marked by a line drawn from the longest possible stay in $0.4 \mu\text{T}$ level to the thresholds defined as short-term exposure limits for general public and occupational exposures. The diagram is in logarithmic scalar, thus it is assumed that the line between these points is close to straight. The region above this line is defined as intolerable region.

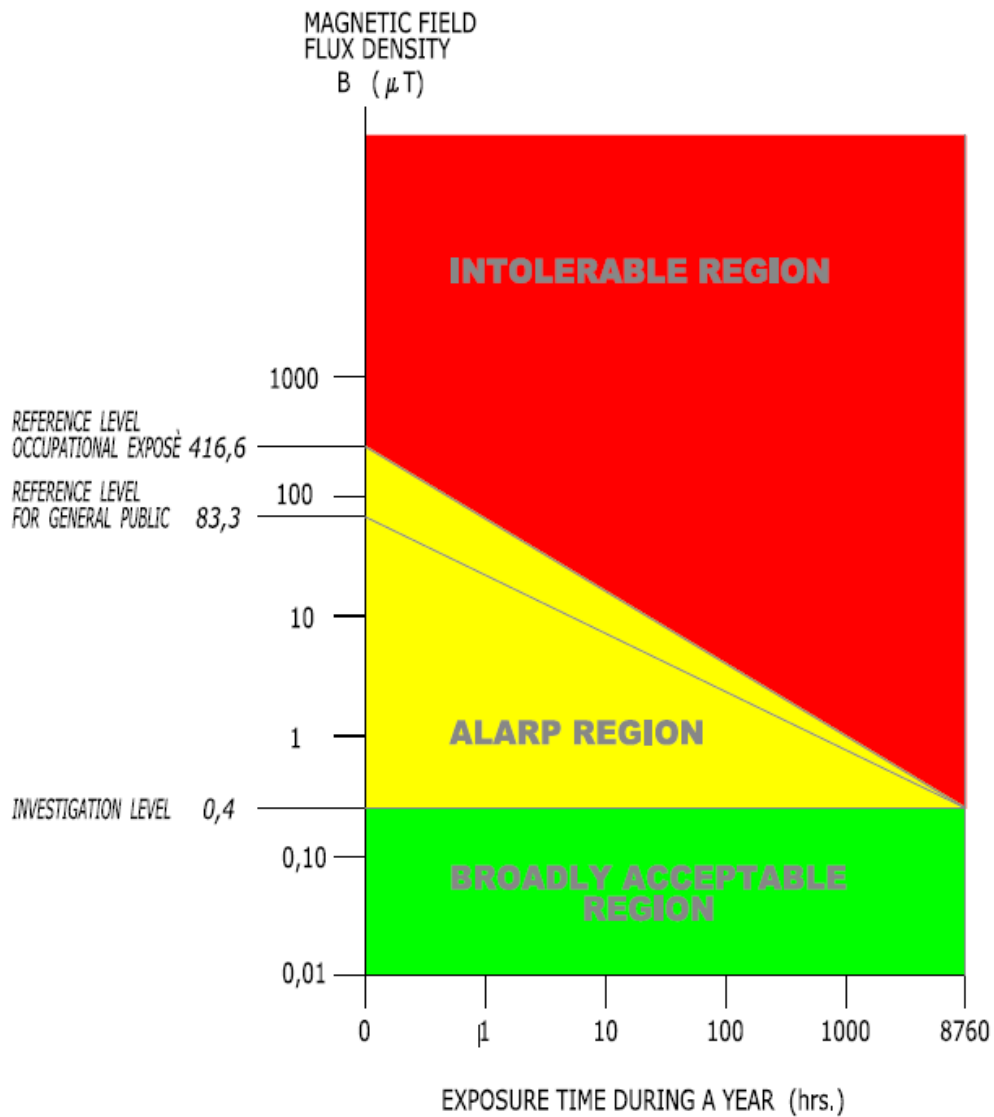

Figure 1.3 - ALARP diagram for ELF EMF human exposure risk

The overall conclusion is that the risk related to human exposure to HV AC and DC current magnetic field for the scope defined for this study is low, most parts is in green broadly acceptable region, few in ALARP region and only one in red area. This is due to two main aspects; first, the predicted magnetic field flux density is generally low compared to the defined thresholds and second, the exposure of human is very much limited due to the operation philosophy of facilities based on remote monitoring and infrequent inspections. Following are the results from this study with respect to human exposure;

2.1.1 HV DC and AC current - onshore substation

HV DC current - Onshore substation - Calculated magnetic field flux density				
Levels	Investigation level	Reference level for general public exposure	Reference level for occupational exposure	Remarks / Recommendations / ALARP measures
Limits	Not defined	400 mT	2 T for head and trunk 8 T for limbs	
Areas				
DC cables inside the substation fenced area		Vertical: 204 µT in a distance of 1 m Horizontal: 200 µT in a distance of 1 m In fault condition, the values are slightly higher Flux density of 400 mT is not generated.	Flux density of 2 T/8 T is not generated.	Since the calculated values even in close distance to sources are much lower than reference levels for exposure of general public and workers, the exposure time and duration will be irrelevant.
Does the calculated value exceed the limit?	N/A	No	No	
DC cables outside the substation fenced area		Vertical: 300 µT up to 2 m above the cables Horizontal: 300 µT 3 m from the cables In fault condition, the values are slightly higher Flux density of 400 mT is not generated.	Flux density of 2 T/8 T is not generated.	Since the calculated values even in close distance to sources are much lower than reference levels for exposure of general public and workers, the exposure time and duration will be irrelevant. ALARP measure: evaluate the installation of signs at the area DC cable leaves the facility to enter the sea. Example: "Keep distance - HV cable, static magnetic field", otherwise the area should be provided by fences. This is to protect people with implanted electronic devices or implants containing ferromagnetic material, where the restriction level is 0.5 mT.
Does the calculated value exceed the limit?	N/A	No	No	

Notes:

According to clarification in appendix 3, requirements given in TR0926 have to be followed and complied with in all areas inside the facility's zone, i.e., areas secured by fences. On the other hand, requirements given by Norwegian radiation protection authority have to be followed and complied with in all areas outside the facility's zone. In practice, there is no difference with respect to investigation levels defined in both sources, which is 0.4 µT. Regarding exposure of general public, the Norwegian radiation protection authority's threshold of magnetic field flux density is 200 µT which is about 2.5 times larger than the value given by ICNIRP. i.e., 83.3 µT. This difference however has no real effect on the evaluations performed in this study since there are no interfaces between the facilities defined in scope of work of this study (onshore and offshore) and general public areas / buildings (e.g., schools, hospitals, office buildings) as well as residential areas. The areas outside the fences is however open for general public and in cases where investigation level have been exceeded, ALARP measures such as use of warning signs have been recommended.

HV AC current - Onshore substation - Calculated magnetic field flux density				
Levels	Investigation level	Reference level for general public exposure for 60 HZ	Reference level for occupational exposure for 60 HZ	Remarks / Recommendations / ALARP measures
Limits	0.4 µT	83.3 µT (200 µT by NRPA)	416.6 µT	
Areas				
Onshore substation - AC cables to transformers	Horizontal: to get below 0.4 µT, the person needs to be at least 35 m away from the furthest out 3 phase cable. Both cables together generate magnetic field stronger than 0.4 µT with an extension of 65 m from mid-point between cables to both train. Since the area within the fences is only 95 m wide, then the general public can be also exposed for this level.	Vertical: It is assumed that the cables hang from the masts at an elevation about 7 m. Perimeter for magnetic field stronger than 83,3 µT is about 5m from ground level and thus no exposure to this level is foreseen.	Flux density of 416.6 µT is not generated.	Assuming that the area outside of the fence is quite a remote place and visit by general public will take place in rare occasion, then widening of facility from 95 m to 130 m is deemed to be unnecessary. Because of low level of flux density and short term exposure of any bystander, the risk for ELF magnetic field outside the fences is assessed to be extremely low. ALARP measure: evaluate the installation of signs at the periphery of the facility to warn public to stay away from the facility. Example: "Keep distance - HV installation"
Does the calculated value exceed the limit?	Yes, but long term exposure is not likely	No	No	
Onshore substation - AC cables to bushings	Horizontal: to get below 0.4 µT, the person needs to be at least 45 m away from the transformers. Both transformers together generate magnetic field stronger than 0.4 µT with an extension of 70 m from midpoint between transformers. Since the area within the fences is only 95 m wide, then the investigation level will be exceeded by a distance of 22.5 m from the fences.	The reference level for public exposure can be reached in a distance of about 3.5 m from the source but since this area is inside the fences then such risk does not exist.	Flux density of 416.6 µT is not generated.	Since the calculated values even in close distance to sources are much lower than reference levels for exposure of general public and workers, the exposure time and duration will be irrelevant. ALARP measure: evaluate the installation of signs at the periphery of the facility to warn public to stay away from the facility. Example: "Keep distance - HV installation"
Does the calculated value exceed the limit?	Yes, but long term exposure is not likely	Yes, but public exposure is not possible	No	
Onshore substation - AC cables from transformers to converters	Horizontal: to get below 0.4 µT, the person needs to be at least 15 m away from the furthest out 3 phase cable. Both cables together generate magnetic field stronger than 0.4 µT with an extension of 35 m from midpoint between cables to both train. Since the area within the fences is 95 m wide, then this is only limited to areas inside the facility.	Vertical: The reference level for public exposure can be reached in a distance of about 1m above the cables but since this area is inside the fences then such risk does not exist.	Flux density of 416.6 µT is not generated.	ALARP measure: Inside onshore converter substation, HVDC equipment such as reactors can generate magnetic field. It is recommended that rest room planned on second level adjacent to HV converter area is relocated to provide maximum distance.
Does the calculated value exceed the limit?	Yes, but long term exposure is not likely	Yes, but public exposure is not possible	No	

2.1.2 HV DC and AC current - Utsira HPH

HV DC current - UHPH - Calculated magnetic field flux density				
Levels	Investigation level	Reference level for general public exposure	Reference level for occupational exposure	Remarks / Recommendations / ALARP measures
Limits	Not defined	400 mT	2 T for head and trunk 8 T for limbs	
Areas				
DC cables, riser, hang-off area, DC cable route to converters		Vertical: 200 µT in a distance of 0.5 m Horizontal: 220 µT in a distance of 0.5 m In fault condition, the values are slightly higher. Flux density of 400 mT is not generated.	Flux density of 2 T/8 T is not generated.	Since the calculated values even in close distance to sources are much lower than reference levels for exposure of general public and workers, the exposure time and duration will be irrelevant. ALARP measure: evaluate the installation of signs warning signs at the areas close to the cable risers, hang-off, and cable route to warn the staff not to stay close to the cables. In case any of offshore staff has implanted electronic devices or implants containing ferromagnetic material, then the restriction level is 0.5 mT and he is not allowed to enter this area.
Does the calculated value exceed the limit?	N/A	No	No	

HV AC current - UPHU - Calculated magnetic field flux density				
Levels	Investigation level	Reference level for general public exposure for 60 HZ	Reference level for occupational exposure for 60 HZ	Remarks / Recommendations / ALARP measures
Limits	0.4 µT	83.3 µT (200 µT by NRPA)	416.6 µT	
Areas				
Utsira HPH - AC cables from DC/AC converter to AC transformers	To get below 0.4 µT, the person needs to be at least 6 m away from the furthest out 3 phase cable. Both cables together generate magnetic field stronger than 0.4 µT with an extension of 16 m from midpoint of cables between both trains.	To be exposed for 83.3 µT, person should be in a distance less than 1 m from cables. This level is for general public exposure and not relevant for the offshore platform. Flux density exceeding 200 µT is not generated.	Flux density of 416.6 µT is not generated.	Since the calculated values even in close distance to sources are much lower than reference levels for exposure of general public and workers, the exposure time and duration will be irrelevant. ALARP measure: evaluate the installation of warning signs at the area close to the cables.
Does the calculated value exceed the limit?	Yes, but UHPU is a NNM platform and prolonged occupational exposure is not possible	Yes, but public exposure is not possible	No	
Utsira HPH - transformers bushings	To get below 0.4 µT, the person needs to be at least 60 m away from the transformers. Both transformers together generate magnetic field stronger than 0.4 µT with an extension of 120 m from midpoint between transformers. This means that all areas on the platform will see that level of flux density.	The reference level for public exposure 83 µT can be reached in a distance of about 7 m from the source but since this area is part of offshore facility then such risk does not exist. To be exposed for 200 µT, one have to be closer than 3m from the bushings.	Flux density of 416.6 µT could be possible in distances closer than 3 m from bushings. Since transformers are located inside the rooms with adequate spacing, the exposure of areas outside the room with such flux density is remote.	Stair tower and escape chute area at north side can be exposed for moderate magnetic field at public exposure level, however since the occupational exposure level is much higher and platform is a NNM installation, no further measures assumed to be required for these areas. Risk reduction measure: entrance to transformer room shall follow the work permit system with strict time limitation for entrance to the room when the transformer is in operation. Since the reference level for occupational exposure exceed at places 3 m from the bushings, if necessary at all, any inspection to the room requiring approach to the equipment shall not exceed more than few minutes. In addition, a sign board at the entrance door to the transformer room warning about the hazard is recommended. For instance, "No entrance, Non-ionizing magnetic field) ALARP measure: evaluate installation of warning signs at the area close to the HV transformer rooms. For example "keep distance, HV area".
Does the calculated value exceed the limit?	Yes, but UHPU is a NNM platform and prolonged occupational exposure is not possible	Yes, but public exposure is not possible	Yes	
Utsira HPH 33 kV GIS	To get below 0.4 µT, the person needs to be at least 20 m away from the UHPH GIS.	Flux density exceeding 83.3 µT is not generated. In a distance of 3m, the flux density could be as high as 13 µT.	Flux density of 416.6 µT is not generated.	Since the calculated values even in close distance to sources are much lower than reference levels for exposure of workers, the exposure time and duration will be irrelevant. ALARP measure: evaluate installation of warning signs at the area close to the HV transformer rooms. For example "keep distance, HV area".
Does the calculated value exceed the limit?	Yes, but UHPU is a NNM platform and prolonged exposure is not possible	No	No	

2.1.3 HV AC current - bridge between Utsira HPH and Johan Sverdrup LQ platform

HV AC current - Bridge - Calculated magnetic field flux density				
Levels	Investigation level	Reference level for general public exposure for 60 HZ	Reference level for occupational exposure for 60 HZ	Remarks / Recommendations / ALARP measures
Limits	0.4 μ T	83.3 μ T (200 μ T by NRPA)	416.6 μ T	
Areas				
Bridge between Utsira HPH and Johan Sverdrup - AC cables on bridge	Vertical: The investigation level is reached in a distance of about 8m above or below the cables. Thus this will affect the whole walkway on the bridge.	Maximum level of 15 μ T can be expected in about 1 m distance from the cables. 3 μ T can be expected in the walkway. Flux density of 83.3 μ T is not generated.	Flux density of 416.6 μ T is not generated.	Since the calculated values even in close distance to sources are much lower than reference levels for exposure of general public and workers, the exposure time and duration will be irrelevant. ALARP measure: evaluate to locate the cables underside the bridge instead of routing on the top to reduce the exposure of head and upper body parts. It is also recommended to locate the cables at the side allocated for the lift truck traffic, away from the personnel walkway.
Does the calculated value exceed the limit?	Yes, but UHPU is a NNM platform and prolonged occupational exposure is not possible	No	No	

2.1.4 HV AC current - Johan Sverdrup

HV AC current - Johan Sverdrup - Calculated magnetic field flux density				
Levels	Investigation level	Reference level for general public exposure for 60 HZ	Reference level for occupational exposure for 60 HZ	Remarks / Recommendations / ALARP measures
Limits	0.4 μ T	83.3 μ T (200 μ T by NRPA)	416.6 μ T	
Areas				
Johan Sverdrup platform - HV AC cables	Vertical: The investigation level is reached in a distance of about 4m above or below the cables. Thus this might affect the whole walkways on the decks.	A maximum level of 5 μ T can be expected from the cables Flux density of 83.3 μ T is not generated.	Flux density of 416.6 μ T is not generated.	ALARP measure: evaluate to locate the cables underside the decks instead of routing on the top to reduce the exposure of head and upper body parts or in case not possible provide the maximum distance from the escape / access routes.
Does the calculated value exceed the limit?	Yes, since these are the walkway, then prolonged exposure is not possible	No	No	
Johan Sverdrup platform - HV AC cable GIS termination Johan Sverdrup	To get below 0.4 μ T, the person needs to be at least 8 m away from the termination points.	Flux density of 40 μ T could be possible in a distance of about 1 m from the termination points. Flux density of 83.3 μ T is not generated.	Flux density of 416.6 μ T is not generated.	Utility rooms / corridors adjacent the GIS room can be exposed for low magnetic field, above 0.4 μ T. However, since none of these areas are considered to have a status as a workshop or office, then no measure is deemed to be required. As an ALARP measure, evaluate the installation of warning signs at the area close to the GIS room. For example "keep distance, HV area".
Does the calculated value exceed the limit?	Yes, but prolonged exposure is not expected	No	No	

2.2 Effect of static magnetic field on compass performance

Concerning the compass deviation, the calculated maximum values are significant where cables are situated at low depths, reaching about 35-50° close to shore in normal and fault operation respectively, reduced about 8-15° some 100 m further out when depths are reaching 40 m. Geographic extent of areas/zones with such high compass deviation near shore is shown in the appendix 2. The deviation may be regarded as insignificant in distances of about 150-200 m away from the cable route. For the majority of the cable route the cables are laid in deeper water which will decrease the maximum level of deviation to the size of 0.1-5°.

The consequences concerning navigation at sea are deemed to be low based on assumption that the compass is seldom utilized for navigational purposes today. The major deviation is close to land where maps are more applicable to e.g. avoid reefs.

2.3 Marine environment exposure risk by static EMF

Evaluations carried out to assess the exposure of marine environment have been documented in chapter 8. Since the current knowledge regarding effects from anthropogenic EMF on the marine environment is limited and research results shows relatively inconsistent detection ranges of EMF for the different marine species, then to draw a definite conclusion would be difficult. Following table summarizes the findings from this study. The overall conclusion is that the marine organisms in vicinity of cables will presumably be affected by the magnetic field but the degree of effect cannot be determined.

Table 2.1 - Detection thresholds for marine organism

Selected detection thresholds for marine organisms	Maximum detection value	Remarks
Areas	168 µT	
HVDC subsea power cables		A worst case scenario of 0.1 m burial depth has been used in the calculations. The Earth's geomagnetic field (approximately 50 µT) has not been accounted for in the calculations.
Does the calculated value exceed the limit?	Yes	The intensity of induced magnetic field will be experienced as a gradient relative to the distance from the cable, both vertically and horizontally. Operational mode: Highest peak at 180 µT. The intensity of the magnetic field has decreased to 70 and 30µT at approximately 2 and 4 meters away from the cables, respectively (reduced to background level). Fault mode: Highest peak at 220 µT. The intensity of the magnetic field has decreased to 70 and 30µT at approximately 3 and 7 meters away from the cables, respectively (reduced to background level).

Calculations shows that the expected magnetic field generated from the planned Utsira HVDC cables will exceed the relative detection threshold in close range. Some research indicates some behavioural effects in certain experiments for species that utilises the magnetic field for navigational purposes (e.g. eel), however these effects have either been evaluated as small or the results have not been suitable to use to determine potential negative or positive environmental impacts. Since there are no clear information on the effect threshold, the calculated magnetic field cannot be compared to potential effect thresholds.

Due to the limited research on potential adverse effects on marine organisms from EMF, it is suggested, during the following phases, a more detailed literature review to gain more specific information is carried out.

2.4 General risk reduction measures

The magnetic field from electrical equipment may in general be reduced effectively by the following measures

- Reduce current flow, e.g. by reducing consumption or increase voltage level
- Keep distance between conductors as low as possible, trefoil for sets of AC-cables
- Increase distance between conductors and sensitive areas
- Establish active or passive current loops between source of field and sensitive areas
- Ferromagnetic shielding (AC only)
- High conductivity screen (AC cables only)

All measures may have economical, practical or environmental consequences and/or issues depending on e.g. the type of installation, existing or planned installation and the surroundings.

2.4.1 Human exposure

Exposure risk to magnetic field can also be reduced by limiting the frequency and duration of visits to areas susceptible for higher magnetic field flux intensity.

Layout design of facilities shall follow all the criteria required by working environment best practices, including the aspects related to ELF magnetic field to provide an optimal solution for a healthy working environment.

2.4.2 Marine environment exposure

In spite of the scarce literature on the subject there are still some potential aspects to consider regarding to the marine environment. Changing the burial depth reduces the strength of the magnetic field by increasing the distance between the cable and the marine organism. Even though, the most prominent way of reducing the produced magnetic field is to choose a proper cabling technique. For instance, a technique where the magnetic fields from several conductors cancel each other out could be an option. This would consequently reduce the anthropogenic magnetic field strength. Moreover, other cable design parameters, such as conductivity and permittivity, could also affect the emitted magnetic field.

3. ABBREVIATIONS

AC	Alternating Current
ALARP	As Low As Reasonably Practicable
DC	Direct Current
ELF	Extreme Low Frequency
EMF	Electromagnetic Field
FBD	Functional Block Diagram
GIS	Gas Insulated Switchgear
HSE	Health, Safety and Environment
HV	High Voltage
HVDC	High Voltage Direct Current
IARC	International Agency for Research on Cancer
ICNIRP	International Commission on Non Ionizing Radiation Protection
IGBT	Insulated Gate Bipolar Transistors
LER	Local Equipment Room
LQ	Living Quarter
NNM	Normally Not Manned
NRPA	Norwegian Radiation Protection Authority
RI	Radio Interference
SWG	Switchgear
UHPH	Utsira High Power Hub
VSC	Voltage Source Converter

4. REFERENCES

- /1/ APPENDIX A - SCOPE OF SERVICES, Utsira High Power Hub & Johan Sverdrup Field Centre Electromagnetic Field Study
- /2/ Contract No.: 4502805376, Utsira High Power Hub & Johan Sverdrup Field Centre Electromagnetic field study
- /3/ Statoil TR0926, Working Environment, Ver. 4, valid from 2012/03/05
- /4/ Ramboll report, Utsira Elektrifisering luftledninger, Rev.03, 2013/03/07
- /5/ Ramboll report, Utsirahøyden elektrifisering virkninger for miljø og samfunn, rev.02, 2012/12/10, Ref. 050001
- /6/ Aker report, EMF assessment Troll A pre-compression 3&4 FEED, C0030-AS-S-RE-014, Rev.01, 25/03/2011
- /7/ ICNIRP GUIDELINES, FOR LIMITING EXPOSURE TO TIME-VARYING ELECTRIC, MAGNETIC AND ELECTROMAGNETIC FIELDS (UP TO 300 GHZ) PUBLISHED IN: HEALTH PHYSICS 74 (4):494-522; 1998
- /8/ ICNIRP STATEMENT ON THE "GUIDELINES FOR LIMITING EXPOSURE TO TIME-VARYING ELECTRIC, MAGNETIC, AND ELECTROMAGNETIC FIELDS (UP TO 300 GHZ)" PUBLISHED IN: HEALTH PHYSICS 97(3):257-258; 2009
- /9/ Environmental Health Criteria 238, EXTREMELY LOW FREQUENCY FIELDS, Published under the joint sponsorship of the ILO, ICNIRP, and WHO
- /10/ Ikke-ioniserende stråling, våren 2006, Arnt Inge Vistnes.
- /11/ Aibel report; UTSIRA HIGH POWER HUB - 'C' Phase Study Report Case 5, 006222-AI-ARA-0005 Rev.: 02
- /12/ Gill, A.B & Bartlett, M. (2010). Literature review on the potential effects of electromagnetic fields and subsea noise from marine renewable energy developments on Atlantic salmon, sea trout and European eel. Scottish Natural Heritage Commissioned Report No. 401
- /13/ Normandeau, Exponent, T. Tricas, and A. Gill. (2011). Effects of EMFs from Undersea Power Cables on Elasmobranchs and Other Marine Species. U.S. Dept. of the Interior, Bureau of Ocean Energy Management, Regulation, and Enforcement, Pacific OCS Region, Camarillo, CA. OCS Study BOEMRE 2011-09.
- /14/ Cowrie. (2005). Electromagnetic fields review. The potential effects of electromagnetic fields generated by subsea power cables associated with offshore wind farm developments on electrically and magnetically sensitive marine organisms – a review.
- /15/ DONG Energy, Vattenfall. (2006). The Danish Offshore Wind Farm Demonstration Project – Environmental impact assessment and monitoring.
- /16/ Fisher, Cameron and Slater, Michael (2010). Electromagnetic Field Study- Effects of electromagnetic fields on marine species: A literature review. Oregon Wave Energy Trust.
- /17/ Statoil. (2012). Utsira High Power Hub Project. Overall field layout. Project drawing no. 1606011-IKM-Y-XE-0001-01.
- /18/ Statoil. (2012). Utsira High Power Hub Project. Crossing Drawing Typical. Project drawings no. 1606011-IKM-Y-XE-0008-01 and 1606011-IKM-Y-XE-0008-02.
- /19/ Vattenfall. (2010). Impact of Electric and Magnetic Fields from Submarine Cables on Marine Organisms – the Current State of Knowledge (appendix 4).
- /20/ HVDC Light® transmission technology presentation, Lars Stendius ABB Power Systems
- /21/ ABB Technical description of HVDC Light® technology brochure
- /22/ Basis of Design for the Electrical Power System, C145-ABB-E-FD-0002, rev.02
- /23/ Main Power System Philosophy, C145-ABB-E-FD-0003, Rev.01
- /24/ ABB Guidelines for Civil Design of HVDC Modules and Buildings-Utsira High, C145-ABB-E-FD-0001 Rev.02
- /25/ Exposure of humans to electromagnetic fields - Standards and regulations, Ann Ist Super Sanità 2007 | Vol. 43, No. 3: 260-267

- /26/ INTERNATIONAL AGENCY FOR RESEARCH ON CANCER, IARC MONOGRAPHS ON THE EVALUATION OF CARCINOGENIC RISKS TO HUMANS, VOLUME 80, NON-IONIZING RADIATION, PART 1: STATIC AND EXTREMELY LOW-FREQUENCY (ELF) ELECTRIC AND MAGNETIC FIELDS
- /27/ C145-ABB-Q-XE-0002-01, UTSIRA HIGH POWER FROM SHORE LANDFALL AND CONVERTER STATION AREA, OVERALL CIVIL LAYOUT CASE 1, rev. 01
- /28/ UTSIRA HIGH POWER FROM SHORE, CONVERTER STATION CASE 1, 3d VIEW, C145-ABB-C-XM-0002-03
- /29/ UTSIRA HIGH POWER FROM SHORE, CONVERTER STATION CASE 1, PLAN LEVEL 1, C145-ABB-C-XM-0003-01
- /30/ UTSIRA HIGH POWER FROM SHORE, CONVERTER STATION CASE 1, PLAN LEVEL 2, C145-ABB-C-XM-0003-02
- /31/ PLOT PLAN MAIN DECK, EL.500000, C145-FA-L-XE-5001, rev. 02
- /32/ PLOT PLAN LOWER AC-HALL DECK, EL.508000, C145-FA-L-XE-500, rev. 02
- /33/ PLOT PLAN CENTRE DECK, EL.517400, C145-FA-L-XE-5005, rev. 02
- /34/ Preliminary cross sectional drw of bridge (example between P1 & WH)
- /35/ Strac et al. Modelling and calculation of electromagnetic field in the surroundings of a large power transformer, 2009
- /36/ Tesla 2012, Sintef Energi
- /37/ ICNIRP GUIDELINES, ON LIMITS OF EXPOSURE TO STATIC MAGNETIC FIELDS PUBLISHED IN: HEALTH PHYSICS 96(4):504-514; 2009
- /38/ Onshore converter substation layout, C145-ABB-E-XD-0002-02, rev. 01
- /39/ Johan Sverdrup LQ, Cellar deck, C156-AA-L-XF-0001
- /40/ Johan Sverdrup LQ, Main deck, C156-AA-L-XF-0004
- /41/ Grenseverdi og utredningsnivå, Publisert 14.10.2008 , oppdatert: 06.06.2011, 11:06, <http://www.nrpa.no/>

5. INTRODUCTION

5.1 General aspects of offshore electrification from shore

5.1.1 Available technologies

Electrification of offshore installation by hydropower from shore has many HSE benefits compared to conventional local use of gas turbines and generators, among others, reduced CO2 emission, reduced local pollution (NOX), less heavy maintenance, reduced ignition sources and reduced vibration and audible noise. However, HV equipment and cables have their own hazards such as fire, electrical shock and exposure to EMF. Awareness and management of these hazards are required in order to operate the installations safely.

Table below shows the opportunities for electrification of offshore installations based on their distance from shore and the extension of power consumption.

Table 5.1 - Technology Selection for offshore power consumption

	Low power consumption	High power consumption	Extreme high power consumption
Short distance	AC power transmission from shore	AC power transmission from shore	AC power transmission <hr/> Offshore gas turbine
Long distance	DC power transmission from shore	DC power transmission from shore	Offshore gas turbine
Extreme long distance	Offshore gas turbine	Offshore gas turbine	Offshore gas turbine

One of the methods for DC power transmission from shore is based on High Voltage Direct Current (HVDC) Voltage Source Converter (VSC) by application of Insulated Gate Bipolar Transistors (IGBT). This solution is mainly consists of a) transformers, b) HVDC onshore and offshore substations, c) smoothing reactors, d) AC and DC filters and e) cable pair.

Following figure shows the building blocks in ABB HVDC light technology:

HVDC Light® – Building blocks

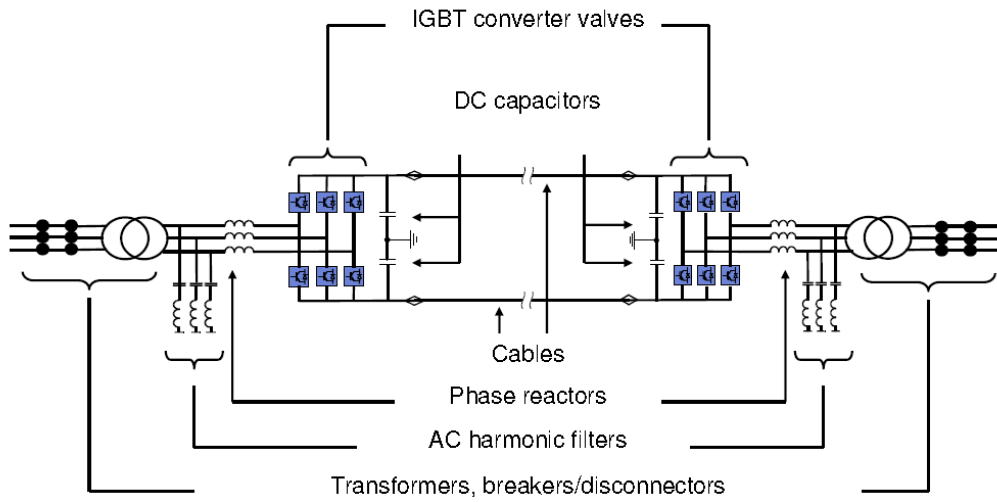

Main-circuit diagram



Figure 5.1 - HVDC light building blocks /20/

Following figure shows the typical layout of an onshore HVDC light substation /24/.

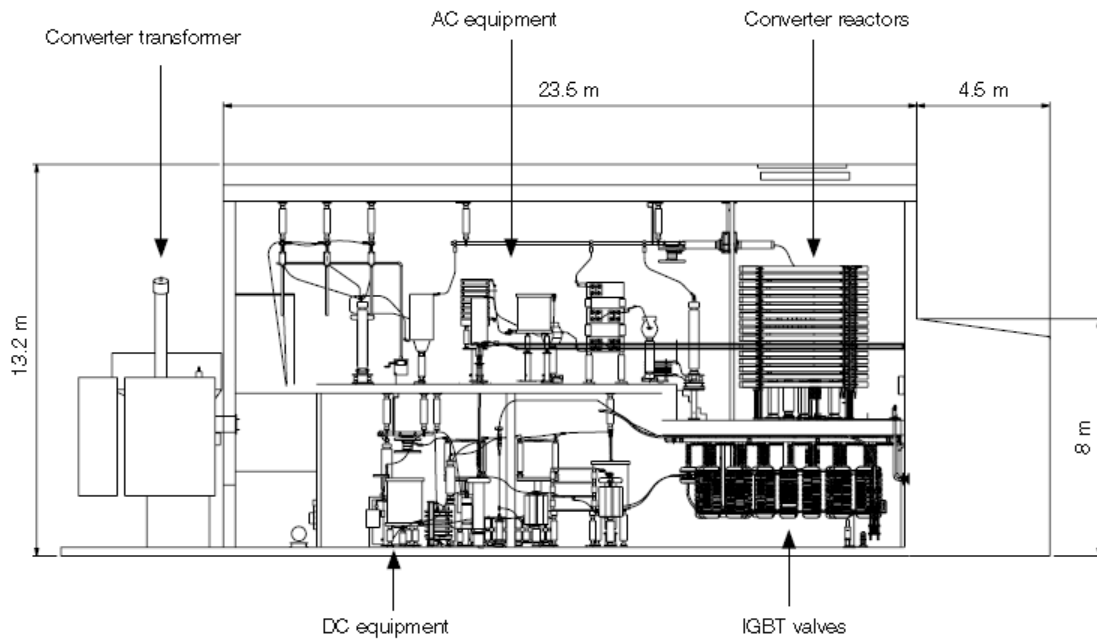

Figure 5.2 - HVDC light substation layout /24/

5.1.2 HV Cables

Figure below shows the structure of HVDC cables used subsea offshore.



Figure 5.3 - HVDC cables used subsea offshore /21/

ABB as supplier of HVDC light claims that DC cables magnetic fields can be eliminated if HVDC Light® cables are laid in pairs with DC currents in opposite directions. Ref. /23/ states that the magnetic field from a DC cable is not pulsating but static - just as the earth's natural magnetic field. The strength of the field is 1/10th of the earth's natural magnetic field one meter above the ground immediately above the cable. Thus it says that for this configuration there will be no relevant magnetic fields when using HVDC Light® cables.

5.1.3 HV Transformers and switchgears

Transformers are the devices that transfer electrical energy from one circuit to another through electromagnetic induction, usually in order to transform the voltage to a higher or lower level. The principle is that the alternating current is passed through the primary coil (the input) which creates a changing magnetic field in the iron core. The changing magnetic field then induces alternating current of the same frequency in the secondary coil (the output) which may have a different number of turns thus changing the voltage. Transformers only work with alternating current. Using direct current will create a magnetic field in the core but it will not be a changing magnetic field and so no voltage will be induced in the secondary coil.

The switchgear serves two main purposes, protective switching of the equipment through relays due to faults in the system and switching due to planned actions as maintenance, inspections, equipment exchange etc.

5.2 General aspects of physics behind formation of electromagnetic field

5.2.1 Electromagnetic spectrum

Electromagnetic waves behave quite differently depending on their frequencies. Figure 5.4 (from ref. /10/) shows an overview commonly called the electromagnetic spectrum. Visible light, radio

waves, gamma radiation, etc. are examples of electromagnetic waves. In this chart 50Hz is also indicated, but there is not any kind of waves here, because by so low frequency it is practically impossible to get sufficiently far away from the source so that the electromagnetic waves are developed.

Det elektromagnetiske spekteret

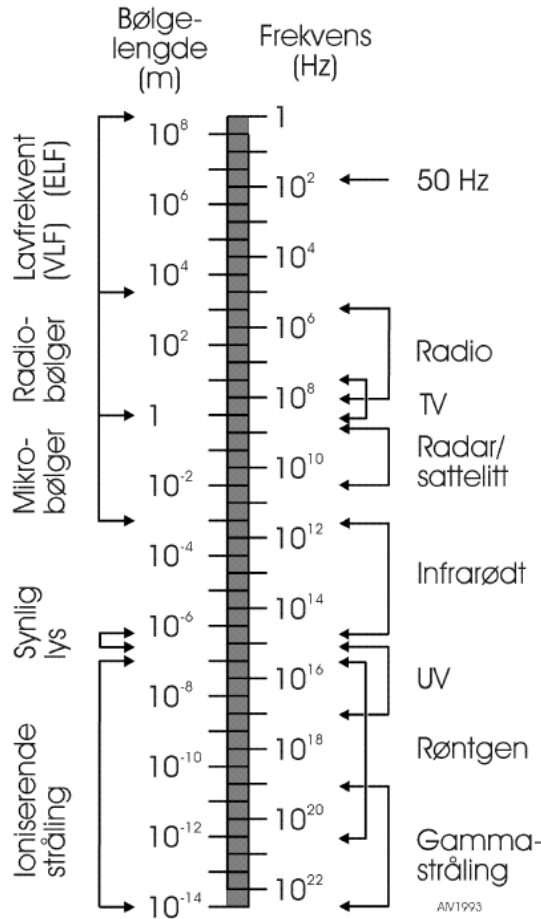

Figure 5.4 - The electromagnetic spectrum (Figure 2.2 in ref. /10/)

James Clerk Maxwell's four equations constitute the basis of electromagnetic field studies. There are infinitely many solutions of Maxwell's equations corresponding to the infinite number of geometries and conditions that might be imagined. For a given set of geometry, material properties, the boundary conditions and excitation, however, Maxwell's equations have only one solution. One well-known solution of Maxwell's equations is the solution applicable to the empty room (far from all boundary conditions). The solution is called an electromagnetic wave, as shown in Figure 5.5.

Electromagnetic waves are characterized by among others that electric and magnetic vectors are perpendicular to each other, that there is a fixed relationship between them and that energy propagates (moves) in a particular direction given by the so-called pointing vector.

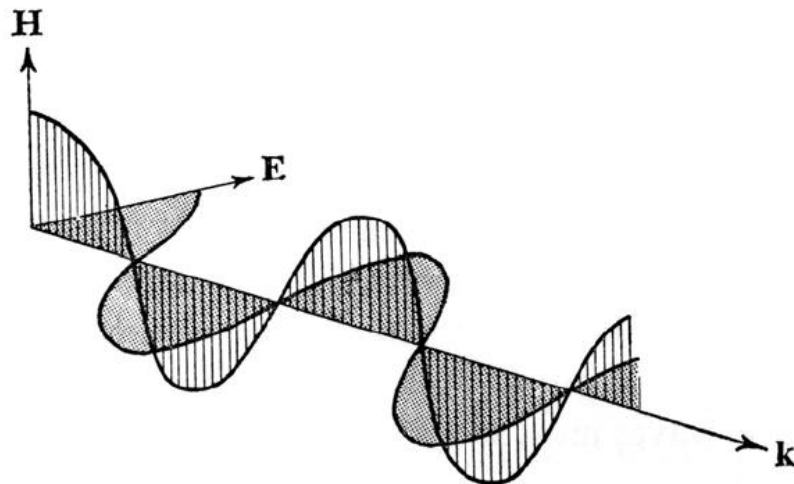

Figure 5.5 An electromagnetic wave is a special solution of Maxwell's equations. The solution applies primarily for the empty space (or for purely homogeneous media) (Figure 2.1 in ref. /10/)

However, as said this picture is not valid for low frequency, e.g., 50 or 60 Hz. In the near zone the electric and magnetic fields from a source are independent both with respect to size and orientation, but in the remote zone, it behaves more like an electromagnetic wave. In the remote zone, the EMF behaves as waves and radiation, while in the near zone radiation is a misleading term. The transition occurs when the distance between the source and the place we consider is about one "calculated wavelength", which the calculated wavelength λ is defined as:

$$\lambda = c / f$$

Here f is the frequency of the current / voltage variation in the source, and c is the speed of light. Transition area depends also to some extent on the size of the source relative to λ . The area that is closer to the source than c / f is called the near zone, while areas further than c / f from the source is said to be in remote zone.

Figure below shows electric and magnetic field generated by direct current.

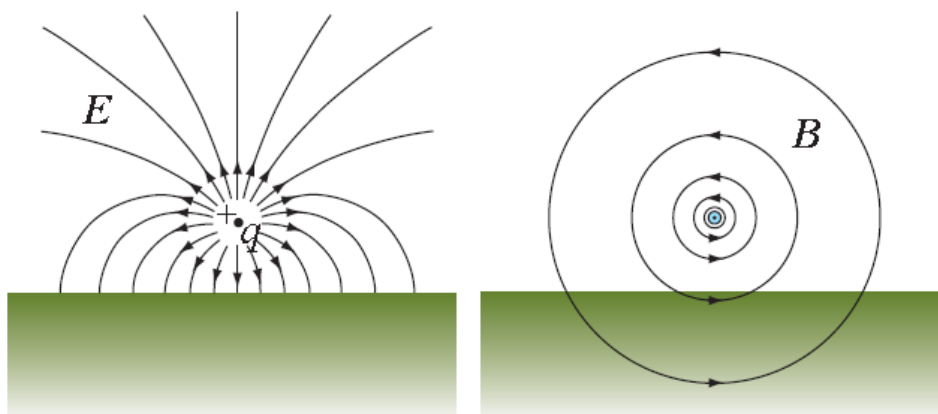

Figure 5.6 Electric and magnetic field from an infinitely long straight conductor runs parallel over an infinite level with infinite thickness (earth). Field lines are also shown. (Figure 2.3 in ref. /10/)

For further elaboration reference is made to ref. /10/.

5.2.2 Direct and alternating currents

Electrical currents flowing in the conduction of electrical equipment, cables and overhead lines are generating surrounding magnetic fields. Static DC-currents and alternating AC-currents are generating static and alternating magnetic fields respectively, thus there are two main differences to the magnetic fields subject to this assessment.

Static magnetic fields as generated by the DC-current are principally equal to that of the bar magnet and to the earth (geo) magnetic field which orientate the compass needle. The intensity of this geomagnetic field will vary across the globe with respect to latitude and longitude, where measurements have shown variations between 30 and 70 μ T.

Alternating (time varying) magnetic fields as generated by the AC-current varies in time with the frequency of the current flow. The frequency of AC-current in power supply systems is usually between 50 Hz and 60 Hz, both within the lower range of the ELF-band (Extreme Low Frequency).

The magnitude of the magnetic field from electrical conductors used in power distribution (AC and DC) is dependent upon several factors. Of significant importance are

- Magnitude of the current (power transfer)
- Number of conductors, separation distance and orientation

The magnetic field reduces most effectively by increasing the distance between the source and sensitive objects or areas. The effect of increasing the distance depends upon the characteristics of the source.

5.3 General risk aspects of human exposure to magnetic field and the defined thresholds

5.3.1 Time varying magnetic field

Risk related to human exposure to ELF EMF has been elaborated thoroughly in ref. /9/. Guideline for the safe exposure of workers and the general public has been issued by the International Commission on Non Ionizing Radiation Protection (ICNIRP) ref. /7/.

In general protection of human against dangerous agents is achieved by providing exposure or dose limits for each particular agent. The limits are defined by the health thresholds where resulted biological effects initiate health detriment. The goal is to keep the exposures below such thresholds. In addition precautionary and ALARP (as low as reasonably practicable) measures can be adopted to provide further risk reduction and higher protection against hazards.

EMF exposure, depending on its level, time duration and coupling mechanism of the external field with the exposed body, can result in different biological responses in human body with different consequences. Some biological effects can lead to adverse health effect.

Table below extracted from ref. /25/ outlines relevant mechanisms of interaction, adverse effects, biologically effective physical quantities (dosimetric quantities) and reference levels for ELF EMF.

Table 5.2 - Relevant mechanisms of interaction, adverse effects, biologically effective physical quantities (dosimetric quantities) and reference levels for ELF EMF, ref. /25/

EMF spectral region	Relevant mechanism of interaction	Adverse effect	Biologically effective physical quantity	External exposure, reference level
Time-varying electric fields (up to 10 MHz)	Surface electric charges	Annoyance from surface effects, electric shock and burn	External electric field strength	Electric field strength
	Induction of internal electric fields and currents	Stimulation of nerve and muscle cells; effects on nervous system functions	Tissue electric field strength or current density	Electric field strength
Time-varying magnetic fields (up to 10 MHz)	Induction of internal electric fields and currents	Stimulation of nerve and muscle cells; effects on nervous systems functions	Tissue electric field strength or current density	Magnetic flux density

Time-varying electric and magnetic fields of frequency up to about 10 MHz induce electric fields and currents inside the body. Such currents and fields cause stimulation of electrically excitable tissues, such as nerves and muscles. The appropriate dosimetric quantities for these phenomena are the induced current density and the internal electric field. /25/

5.3.2 Risk of cancer

Based on ref. /7/, ICNIRP has the view that the results from the epidemiological research on EMF field exposure and cancer, including childhood leukaemia, are not strong enough in the absence of support from experimental research to form a scientific basis for setting exposure guidelines.

However, International agency for research on cancer (IARC) has a slightly different opinion. According to ref. /26/, the overall evaluation of IARC of the extremely low-frequency magnetic fields is that it is classified a possibly carcinogenic to humans (Group 2B) and for static electric and magnetic fields and extremely low-frequency electric fields not classifiable as carcinogenicity to humans (Group 3).

This evaluation is based on that there is limited evidence in humans for the carcinogenicity of extremely low frequency magnetic fields in relation to childhood leukaemia and there is inadequate evidence in humans for the carcinogenicity of extremely low frequency magnetic fields in relation to all other cancers. There is also inadequate evidence in humans for the carcinogenicity of static electric or magnetic fields and extremely low-frequency electric fields.

5.3.3 Basic restrictions and reference levels

Accordingly in establishing exposure limits, ICNIRP defines two classes of guidance, that is, basic restriction and reference level.

Basic restrictions are defined in terms of the appropriate biologically effective quantities, and are set below the threshold for the appropriate critical effects. Due to practical difficulties in measuring or calculating some biologically effective quantities, from basic restrictions reference levels are derived, that are expressed in terms of a directly measurable parameter of the external exposure. /25/

According to ref. /7/ Between 1 Hz and 10 MHz, basic restrictions are provided on current density to prevent effects on nervous system functions. In the frequency range from a few Hz to 1 kHz,

for levels of induced current density above 100 mA m^{-2} , the thresholds for acute changes in central nervous system excitability and other acute effects such as reversal of the visually evoked potential are exceeded.

As a result, in view of the safety considerations, ICNIRP decided that, for frequencies in the range 4 Hz to 1 kHz, occupational exposure should be limited to fields that induce current densities less than 10 mA m^{-2} , i.e., to use a safety factor of 10. For the general public an additional factor of 5 is applied, giving a basic exposure restriction of 2 mA m^{-2} .

Table below shows the basic restrictions for time varying electric and magnetic fields for frequencies up to 10 GHz. f is the frequency in hertz.

Table 5.3 - Basic restrictions for time varying electric and magnetic fields for frequencies up to 10 GHz, ref. /7/

Exposure characteristics	Frequency range	Current density for head and trunk (mA m^{-2}) (rms)	Whole-body average SAR (W kg^{-1})	Localized SAR (head and trunk) (W kg^{-1})	Localized SAR (limbs) (W kg^{-1})
Occupational exposure	up to 1 Hz	40	—	—	—
	1–4 Hz	$40/f$	—	—	—
	4 Hz–1 kHz	10	—	—	—
	1–100 kHz	$f/100$	—	—	—
	100 kHz–10 MHz	$f/100$	0.4	10	20
General public exposure	10 MHz–10 GHz	—	0.4	10	20
	up to 1 Hz	8	—	—	—
	1–4 Hz	$8/f$	—	—	—
	4 Hz–1 kHz	2	—	—	—
	1–100 kHz	$f/500$	—	—	—
	100 kHz–10 MHz	$f/500$	0.08	2	4
	10 MHz–10 GHz	—	0.08	2	4

Tables 5.4 and 5.5 below show the reference levels given by ICNIRP for occupational and public exposure to time-varying electric and magnetic fields. f shall be as indicated in the frequency range column

Table 5.4 - Reference levels for occupational exposure to time-varying electric and magnetic fields, ref. /7/

Frequency range	E-field strength (V m^{-1})	H-field strength (A m^{-1})	B-field (μT)	Equivalent plane wave power density S_{eq} (W m^{-2})
up to 1 Hz	—	1.63×10^5	2×10^5	—
1–8 Hz	20,000	$1.63 \times 10^5/f^2$	$2 \times 10^5/f^2$	—
8–25 Hz	20,000	$2 \times 10^4/f$	$2.5 \times 10^4/f$	—
0.025–0.82 kHz	$500/f$	$20/f$	$25/f$	—
0.82–65 kHz	610	24.4	30.7	—
0.065–1 MHz	610	$1.6/f$	$2.0/f$	—
1–10 MHz	$610/f$	$1.6/f$	$2.0/f$	—
10–400 MHz	61	0.16	0.2	10
400–2,000 MHz	$3f^{1/2}$	$0.008f^{1/2}$	$0.01f^{1/2}$	$f/40$
2–300 GHz	137	0.36	0.45	50

For 60 Hz, i.e., 0.06 kHz frequency, the reference level for occupational exposure for B-field in μT is $25/0.06 = 416.6$

Table 5.5 - Reference levels for general public exposure to time-varying electric and magnetic fields, ref. /7/

Frequency range	E-field strength (V m ⁻¹)	H-field strength (A m ⁻¹)	B-field (μT)	Equivalent plane wave power density S_{eq} (W m ⁻²)
up to 1 Hz	—	3.2×10^4	4×10^4	—
1–8 Hz	10,000	$3.2 \times 10^4/f^2$	$4 \times 10^4/f^2$	—
8–25 Hz	10,000	$4,000/f$	$5,000/f$	—
0.025–0.8 kHz	$250/f$	$4/f$	$5/f$	—
0.8–3 kHz	$250/f$	5	6.25	—
3–150 kHz	87	5	6.25	—
0.15–1 MHz	87	$0.73/f$	$0.92/f$	—
1–10 MHz	$87f^{1/2}$	$0.73/f$	$0.92/f$	—
10–400 MHz	28	0.073	0.092	2
400–2,000 MHz	$1.375f^{1/2}$	$0.0037f^{1/2}$	$0.0046f^{1/2}$	$f/200$
2–300 GHz	61	0.16	0.20	10

For 60 Hz, i.e., 0.06 kHz frequency, the reference level for general public exposure for B-field in μT is $5/0.06 = 83.3$

5.3.4 Company's requirement

Company's TR0926 ch. 4.12.2 states the following requirements for the ELF EMF;

"In general, all human exposure to non-ionizing radiation shall be as low as practicable.

For cabins, offices and other continuous manned areas the following investigation levels apply:

For 50 - 60 Hz electromagnetic fields: 0, 4 μT.

Any exceedence of the investigation levels requires an evaluation of possible actions to reduce the exposure. The evaluation shall include calculations of expected reduction and description of cost impact and other implications of the actions. It shall be emphasised to achieve an exposure level below the investigation-level according to the ALARP principle.

The investigation levels are not based on documented negative health effects. The investigation level aim to reduce exposure to electromagnetic fields according to a precautionary principle as possible negative health effects of long term exposure cannot be excluded. "

5.3.5 Norwegian radiation protection authority's threshold and investigation levels

According to information published 14.10.2008 and updated: 06/06/2011 in Norwegian radiation protection authority web site, re./41/, the magnetic field limit value for the population is 200 μT. It defines also an investigation level of 0.4 μT for the assessment of long-term exposure. Investigation level is set to an annual average of 0.4 μT based on the potential risk of a slight increase in leukaemia cases in children. Re. /41/ requires also that in new facilities where magnetic field will be above 0.4 μT, measures to reduce the level shall be considered. Various measures will be assessed against various considerations, disadvantages, costs, etc. The approach is in line with the Radiation Protection Regulations which requires that all exposure should be kept as low as practicable.

According to clarification in appendix 3, requirements given in TR0926 have to be followed and complied with in all areas inside the facility's zone, i.e., areas secured by fences. On the other hand, requirements given by Norwegian radiation protection authority have to be followed and complied with in all areas outside the facility's zone. In practice, there is no difference with respect to investigation levels defined by both sources, which is 0.4 μT. Regarding exposure of general public, the Norwegian radiation protection authority's threshold of magnetic field flux density is 200 μT which is about 2.5 times larger than the value given by ICNIRP. i.e., 83.3 μT. This difference however has no real effect on the evaluations performed in this study since there are no interfaces between the facilities defined in scope of work of this study (onshore and offshore) and general public areas / buildings (e.g., schools, hospitals, office buildings) as well as residential areas. The areas outside the fences is however open for general public and in cases where investigation level have been exceeded, ALARP measures such as use of warning signs have been recommended.

5.3.6 Typical exposure from home appliances and magnetic field distance dependency

Most fields are inhomogeneous, and the field strength is inversely proportional to the distance power 0 to 4 depending on the source construction and our position in relation to the source. The stated exposure levels are mostly the maximum value of the nearest body part in relation to the source. In cases where we get very close to a source (close relative to body size), exposure averaged over the whole body is considerably lower than the maximum value. However, it is not clear whether it is biologically important to concentrate on the maximum value or a mean value. Whatever be the problems when e.g., shall state magnetic field from an electric shaver when the field is actually differ more than by a factor 1000 over the body. /10/

Figure below from ref. /10/ shows examples of how magnetic flux density varies with the distance from some typical sources.

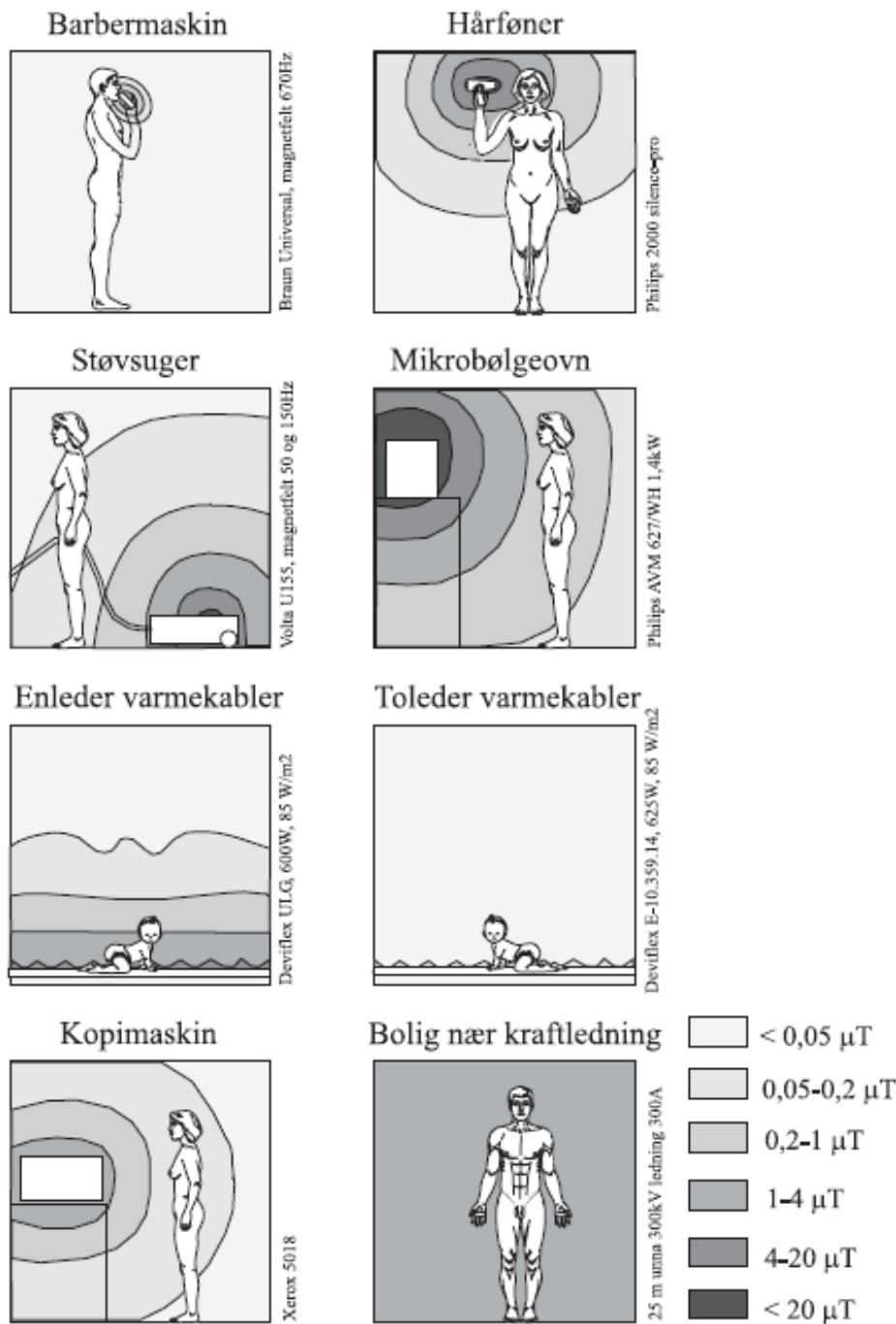

Figure 5.7 - Examples of sources and measured values for low frequency magnetic field (ref. /10/)

5.3.7 Limits of exposure to static magnetic fields

ICNIRP defines the following occupational and general public exposure limits for the static magnetic field in its table 2.

Table 2. Limits of exposure^a to static magnetic fields.

Exposure characteristics	Magnetic flux density
Occupational ^b	
Exposure of head and of trunk	2 T
Exposure of limbs ^c	8 T
General public ^d	
Exposure of any part of the body	400 mT

^a ICNIRP recommends that these limits should be viewed operationally as spatial peak exposure limits.

^b For specific work applications, exposure up to 8 T can be justified, if the environment is controlled and appropriate work practices are implemented to control movement-induced effects.

^c Not enough information is available on which to base exposure limits beyond 8 T.

^d Because of potential indirect adverse effects, ICNIRP recognizes that practical policies need to be implemented to prevent inadvertent harmful exposure of persons with implanted electronic medical devices and implants containing ferromagnetic material, and dangers from flying objects, which can lead to much lower restriction levels such as 0.5 mT.

According to ref./37/, above 2 T, transient effects such as vertigo, nausea and phosphenes have been occasionally observed in some people, but no evidence has been found for any irreversible or serious adverse health effects.

Several studies have reported that individuals exposed to static magnetic fields above 2–3 T experience transient sensory effects associated with motion in a static field gradient such as vertigo, nausea, a metallic taste, and magnetic phosphenes when moving the eyes or head. However, the incidence and severity of these symptoms can be decreased by slowing the rate of motion of an individual through the magnetic field gradient. /37/

5.4 General risk aspects of marine environment exposure to EMF

Marine organisms utilise different sensory systems to gain information about the external environment. These organisms depend on sensory reception for several vital life functions such as feeding, predator avoidance, reproduction and migration. Based on this, it is assessed that an organism's ability to accurately sense its environment through sensory systems is important to its survival /13/.

The origin of EMF in the marine environment is associated with both natural- and anthropogenic sources. Emitted electromagnetic fields from such subsea power cables can be detected by magneto-/electrosensitive species. By detecting these fields, many marine species can use the earth's magnetic field for information to orientate and navigate /13/. The following sections give a basic description of the current understanding of magnetosensitive and electrosensitive species.

Magnetosensitive species

A variety of marine organisms use the Earth's environmental magnetic signals for different behavioural purposes (e.g. feeding, reproduction, refugia). A number of invertebrates and vertebrates have been known to sense, respond to, or orient to magnetic field signals, including molluscs, crustaceans, elasmobranch fishes, bony fishes and sea turtles. It has been assessed that magnetosensitive species will most likely be able to detect EMFs from DC cables and probably to

a lesser (or no) extent from AC cables. However, the mechanism behind the detection and processing of magnetic stimuli in marine organisms is not definitive and there are several proposed and competing models explaining this phenomenon /13/.

It is possible to categorise organisms that can detect magnetic fields into two groups based on their mode of magnetic field detection; induced electric field (iE-field) detection and magnetite based detection /14/.

Induced electric field detection relates to species that are electroreceptive and is generally assumed to be used for navigation. These species can further be categorised as either passive or active. An organism is considered passive when it senses the iE-fields produced by the interaction between ocean currents with the vertical component of the Earth's magnetic field. While an active mode is when the organism senses the iE-field it generates by its own interaction with the horizontal component of the Earth's magnetic field /14/.

The mechanism behind magnetite based detection is not well understood. However, it is thought that magnetosensitive species are sensitive to the Earth's magnetic fields. Furthermore it is suggested that magnetite deposits play an important role in geomagnetic field detection in a relatively large variety of organisms, e.g. salmon, elasmobranchs and whales /16/. The sensitivity to the geomagnetic field for many of these species is also associated with navigation /14/.

5.4.1 Electrosensitive species

Certain marine species that are sensitive to EMFs possess specialised sensory organs which allow them to detect and utilise the signals from natural sources of EMFs. Electroreceptive organisms experience electric fields induced by the movement of charges in their body through the earth's geomagnetic field, which again will depend on the velocity and direction of movement. Such induced electric fields would also be relevant for the Utsira HVDC cables as they can be induced by movement across the cables. Although the main function of the electroreceptor system is to detect weak electric fields, it is also suggested that it can detect magnetic fields. It has been assessed that electrosensitive species (e.g. elasmobranchs, some teleost fish and decapod crustaceans) will most likely be able to detect EMFs from both DC and AC cables, with the highest sensitivity towards DC cables /13/.

Elasmobranchs and their relatives (e.g. sharks, skates and rays) are the most commonly known group of organisms that are known to be electroreceptive. The ability to detect electrical fields (including iE-fields) is likely to vary throughout the life of an elasmobranch. It starts in the embryonic and juvenile stages of the organism's life and the sensitivity will normally increase with age. This applies to uniform electric fields which will occur near the electrodes. However, this has not been calculated with regards to the Utsira HVDC cables/14/.

The remaining electrosensitive species (e.g. non-elasmobranchs) do not possess specialized electroreceptors. Instead they are able to detect induced voltage gradients associated with water movement and geomagnetic emissions. However, the actual sensory mechanism of detection is not properly understood. It has been suggested that the induced electrical fields that these species respond to is associated with peak tidal movements which can create fields in the range of 8-25 μ v/m /14/.

5.4.2

5.4.3 Sensitivity levels towards magnetic- and iE-fields

The elasmobranchs are considered most sensitive to standing DC induced electric fields in the surrounding aquatic environment, which can be induced by standing magnetic fields. However, how they perceive an iE field is complex and depend upon various factors such as cable characteristics, electric current, cable configuration, cable orientation relative to geomagnetic field, the swimming direction of the animal, local tidal movements, etc. As such, the elasmobranchs are capable of detecting iE field from the current flow of the ocean even if there is no cable present, making it difficult to predict distances and directions of response /13/. The actual mechanism for how the elasmobranchs detect magnetic fields is currently subjected to some uncertainties. It has however been shown that elasmobranchs can detect DC magnetic fields in the range between 25-100 μT against the ambient geomagnetic field (approximately 36 μT for areas close to equator) /14/. The ambient geometric field in Stavanger area is 50 μT .

Fish species detecting magnetic fields and iE-fields have been closely related to navigation during long distance migration and the locating of spawning grounds. Very low intensity magnetic fields have been associated with behavioural responses in several species, for both elasmobranchs and other fish species. This has been suggested to be a result of changes in magnetic fields at or below background geomagnetic levels in the range 10 – 50 μT /12/. It must however be emphasised that the detection level varies in the different studies /13/.

Several studies have been performed on invertebrates. Still, the precise sensitivity levels to magnetic fields are not well known and a suggested level of <100 nT have been set. Furthermore, it has been proposed that certain species of decapod crustaceans (e.g., lobsters, crabs) might experience a moderate level of effects from EMFs. This is due to their epibenthic habitat in addition to their relatively low mobility which consequently could expose individual organisms to the highest field strengths /13/.

With respect to marine mammals the detection limit is pure theoretically, since little research has been performed on this group. Some suggestions have been made towards the effect of EMF on stranding of marine mammals. Behavioural changes have also been shown in dolphins with permanent magnetic fields ranging between 32-168 μT /13/.

6. EMF CALCULATIONS

6.1 Terms and principles of magnetic fields

6.1.1 The magnetic field

Considering the term “magnetic field” commonly used when working with static and ELF electromagnetic fields, one usually assess the magnetic flux density or B-field, denoted B and measured in Tesla. Also the magnetic field strength or H-field denoted H and measured in Ampere/meter is used by some. Throughout this assessment, B-fields are considered. The relationship between H- and B-field is

$$B = \mu H$$

where the permeability μ is taking into account the magnetic properties of the surroundings and is given by the relative permeability μ_r and the permeability in vacuum μ_0 as

$$\mu = \mu_r \mu_0$$

6.1.2 Calculating magnetic fields

Electromagnetic fields may be calculated through solving Maxwell’s equations. From these one may derive the law of Biot-Savart for evaluating the magnetic flux density for wires which for a quasi-static solution has the form

$$\mathbf{B}(r) = \frac{\mu}{4\pi} I \int_C \frac{d\mathbf{l} \times \mathbf{r}}{r^2}$$

where \mathbf{r} is the vector to a point P relative to the current carrying conduction, and the integral is evaluated over the path C which encloses the conductor. For a long and straight conductor the equation simplifies to

$$\mathbf{B}(r) = \frac{\mu}{2\pi} \frac{I}{r}$$

The magnetic field in a point P(x,y) is a vector tangential to the closed loop C. Considering multiple cables as bipole HVDC-systems, 3-phase AC systems or parallel power supply systems, the cables will tend to amplify or reduce the field depending on the direction of the current flow and where the point P is relative to the conductors. The contribution from each cable has to be decomposed in order to evaluate the resultant field in point P(x,y) as illustrated below for a single conductor.

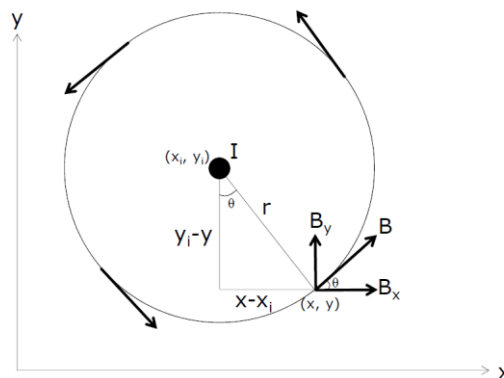

Figure 6.1 - Magnetic field from a long straight wire where the current direction is heading out of the sheet /36/

6.1.3 Calculating compass deviation

The compass deviation due to the HVDC sea cables is calculated considering the following factors:

- Orientation of the cables with respect to true north
- Distance from cables to sea level

True north would be following the line between the actual north and south pole, as opposed to the magnetic pole which move constantly and rarely would equal the true north, thus there will be a declination or compass deviation to the also when no other magnetic field influence is apparent.

Worst case for compass deviation due to the HVDC sea cables would be where cables are aligned with the magnetic north-south axis. The horizontal components of the calculated DC and geomagnetic field vectors are decomposed and added. The angular displacement of the resultant field vector $B_{h,res}$ to true north yield the compass deviation. The following drawing outlines the basic principles for the assessment of compass deviation.

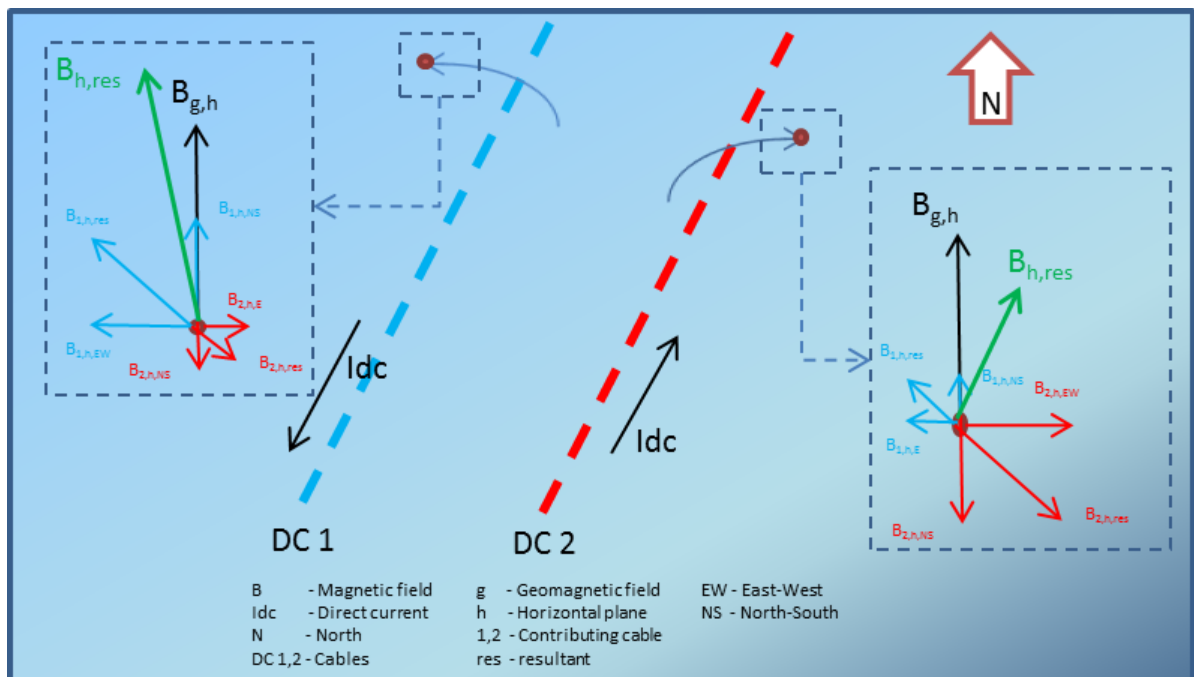

Figure 6.2 - Basic elements considered for compass deviation assessment

6.1.4 General assumptions for calculations

The magnetic field calculations have been performed utilizing an in-house developed program, solving the equations treated in chapter 6.1. The program is capable to simulate the magnetic field flux intensity by providing relevant input data, such as conductor current and phase, number of parallel cables with respective horizontal and vertical displacement and relative permittivity.

- Long straight conductors.
- All cables are shielded.
- Current flow as at maximum transformer/converter utilization.
- Permeability of the surrounding environment (soil, seawater, enclosures, walls etc.) of electrical conductors equals the permeability of vacuum (μ_0).
- Considering only one train operating due to e.g. a cable fault, only one HVDC cable will be operating. In this condition the seawater will carry the return current of the system through electrodes located near the converter stations Haugsneset and at UHPH.
- Consider appendix 1 *Main issues field calculations* for further details.

6.2 DC magnetic field results

6.2.1 Main assumptions and comments

- The source of DC field is the HVDC cables only, the geomagnetic field is not present in the following results.
- Cables from train 1 and 2 are positioned at equal elevation
- When only one train is operating, it's assumed that the current density in the seawater between the sea electrodes is very low, thus the return current contribution to the DC magnetic field is negligible.

6.2.2 Onshore AC/DC Converter station Haugsneset

The bipole configuration of the DC supply consists of one DC cable from each train and a neutral connection to a subsea electrode. Other sources of static magnetic field are not assumed to be present in the following results.

Frequency:	-
Distance phase-phase:	50 m (mid. to mid. each train)
Distance phase-neutral:	~3 m (assumed)
DC voltage level:	±150 kV
Maximum DC current:	
- Normal conditions	1 000 A (±150 kV)
- Fault conditions	1 200 A (150 kV)
Conductor	800 mm ² CU
Cable outer diameter (∅)	88 mm

Following figure shows the magnetic field flux density measured in µT (micro Tesla). Colours refer to threshold values of the B-field [µT] defined on the right side of the figure.

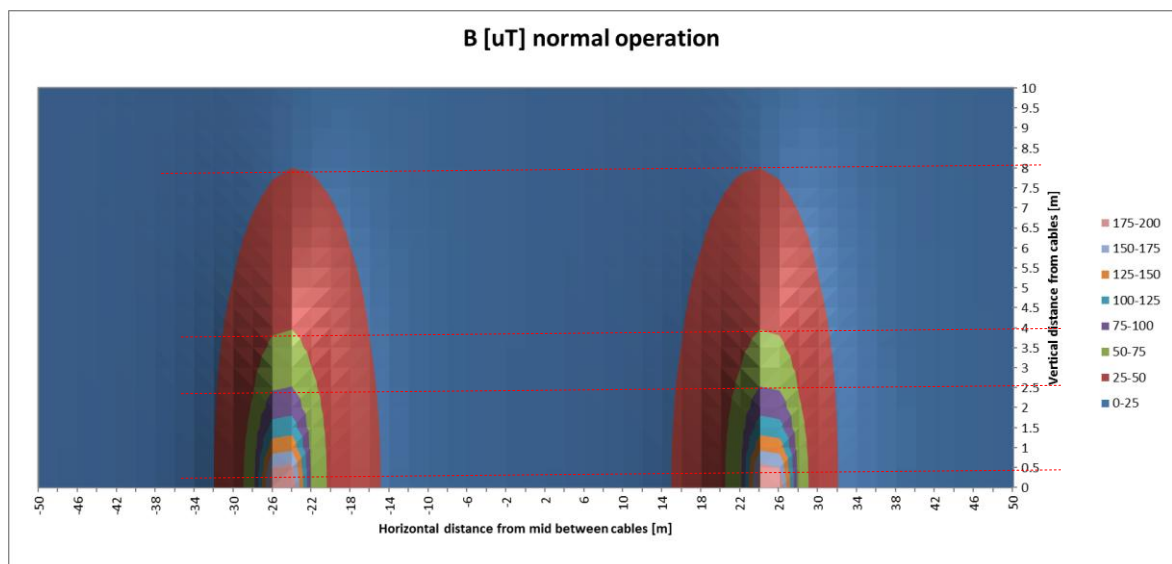

Figure 6.3 - Magnetic field from HVDC cables at the converter station onshore, normal operation

The assumption that the phase-neutral distance is 3 m give reduced magnetic field during fault conditions compared to normal operation due to that the phase-phase distance is larger (50 m).

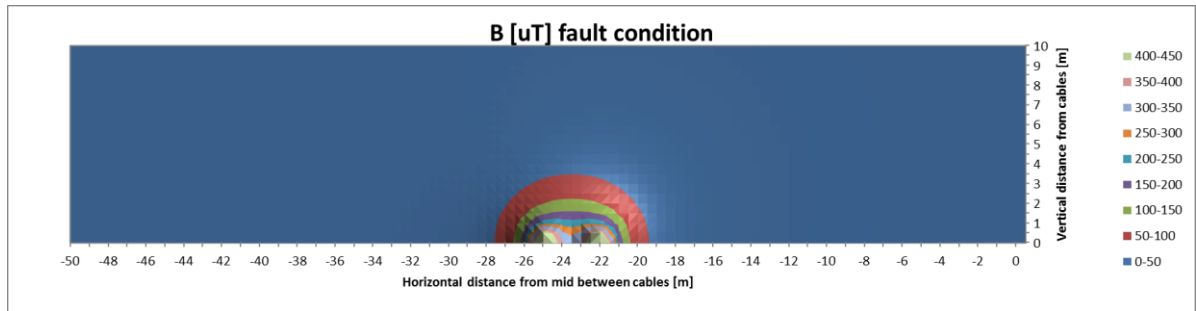

Figure 6.4 - Magnetic field from HVDC cables at the converter station onshore, fault condition

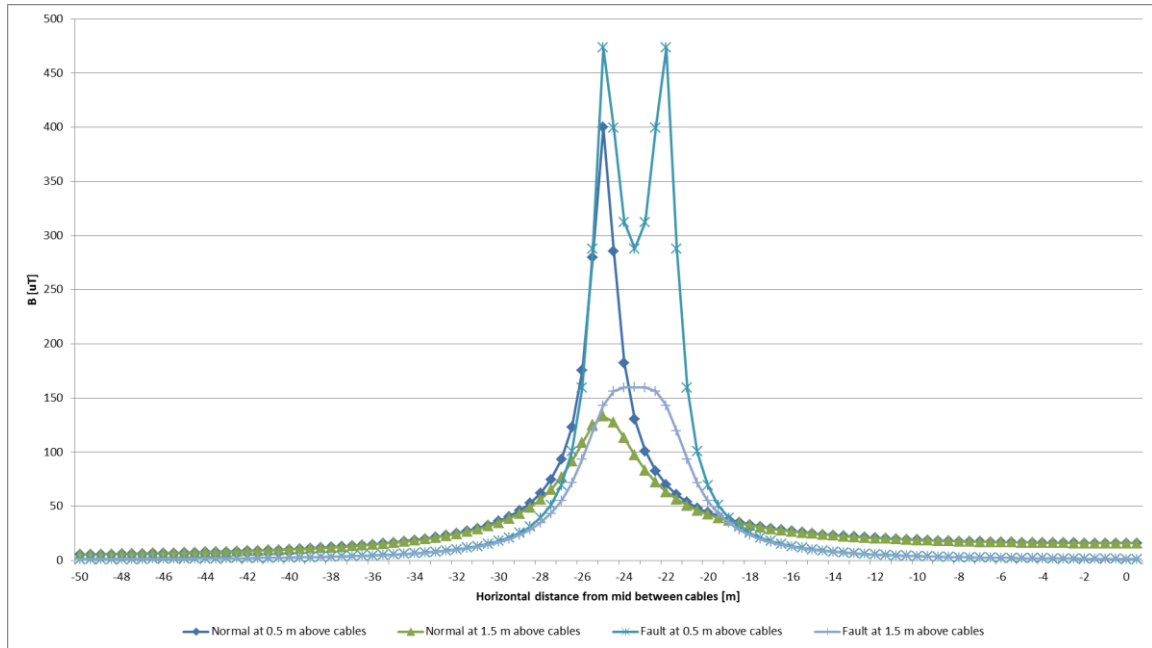

Figure 6.5 Magnetic field from one HVDC cable at the converter station onshore, normal and fault condition

6.2.3 AC/DC Converter station to seabed

This section considers the HVDC cables exiting converter station area and entering seabed through landfall area. Other sources of static magnetic field are not assumed to be present in the following results.

Assuming that the phase-neutral distance is 3 m, the fault condition yields the same magnetic field as in normal operation, shifted 3 m in the horizontal plane.

Frequency:	-
Cable separation:	3 m
Distance Cable-Neutral:	3 m assumed
Depth:	0.6 m below ground
DC voltage level:	±150 kV
Maximum DC current:	
- Normal conditions	1 000 A (±150 kV)
- Fault conditions	1 200 A (150 kV)
Conductor	800 mm ² CU
Cable outer diameter (∅)	88 mm

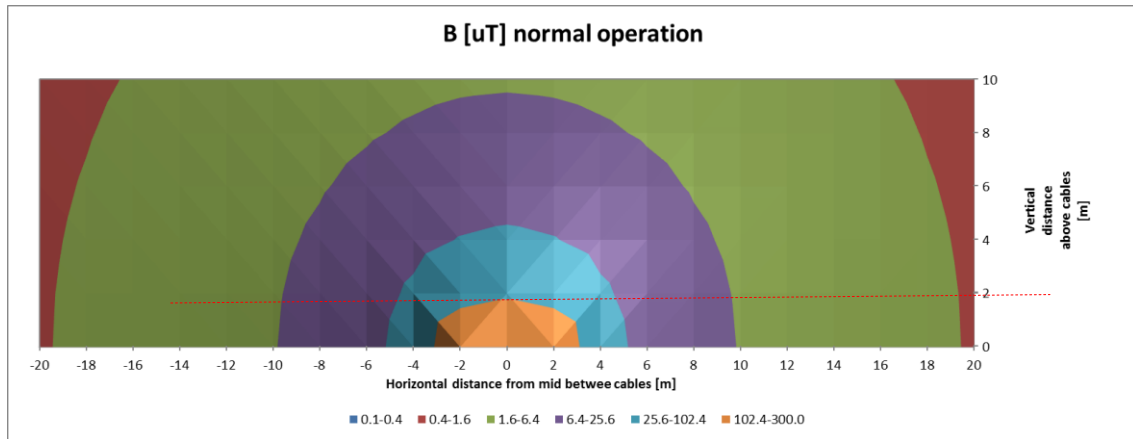

Figure 6.6 - Magnetic field from HVDC cables from converter station to seabed

6.2.4 HVDC sea cable

The HVDC cables follow route as mapped by IKM. Sea cables are often laid in a seabed trench wherever possible, alternatively covered by stones or other protection. Crossing of pipelines or other infrastructure at seabed is usually done by establishing a protective cover between existing object and cable in addition to the final cover. The cable burial depth is uncertain, thus a worst case is evaluated.

Frequency:	-
Cable separation:	vary between 3 m – 4000 m
Distance Cable-Neutral:	no neutral, seabed electrodes
Depth:	0 – ~ 600 m
Cable burial	-0.1 m
DC voltage level:	±150 kV
Maximum DC current:	
- Normal conditions	1 000 A (±150 kV)
- Fault conditions	1 200 A (150 kV)
Conductor	800 mm ² CU
Cable outer diameter (∅)	88 mm

Figures 6.6 to 6.12 presents the EMF calculations related to the marine environment, illustrating the EMF strength as a function of the distance from the DC cables. The vertical point above the cable is set at 1 meter (except for fig. 6.7). The x-axis and y-axis represent the horizontal distance from the DC cables and the EMF strength, respectively. For instance, when a marine organism (e.g. a fish) passes through the magnetic field created by the cables, a current may be induced in the organism dependant on the field strength and the velocity of the organism perpendicular to the cables.

The magnetic field peaks during normal operation are situated above the cables since the electric currents in the two cables go in opposite directions. The horizontal components of the field from each cable will tend to cancel each other out, consequently reducing the resulting magnetic field. During fault mode, only one of the cables will be functioning. Hence, the cables will not affect each other, as during normal operation. Refer to chapter 8 for evaluations from EMF results on marine environment.

Figure 6.6 illustrates the EMF development from the two DC cables when the distance between them equals 3 meters. The two curves represent operational and fault mode, respectively. During fault mode, only one of the cables will be functioning.

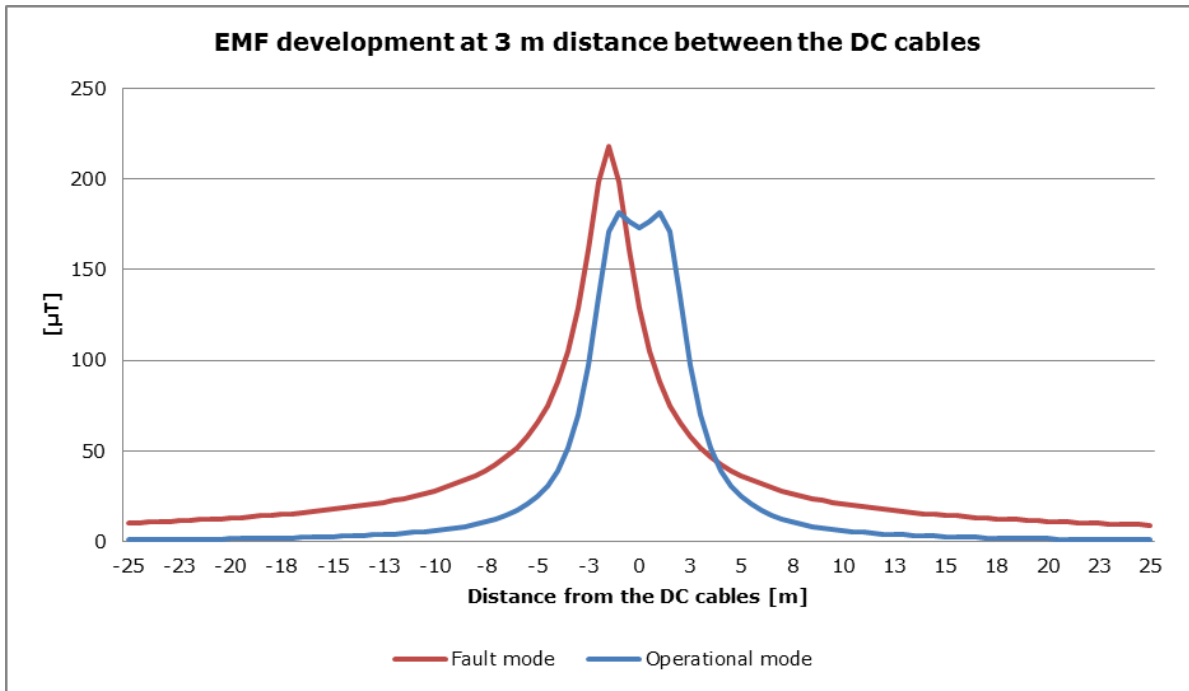

Figure 6.7 - EMF development, 1 m above the DC cables during normal operation and fault mode with 3 meter distance between the two cables

Figure 6.7 illustrates how the EMF will develop during operation at various vertical elevations above the DC cables. The distance between the DC cables is still 3 meter.

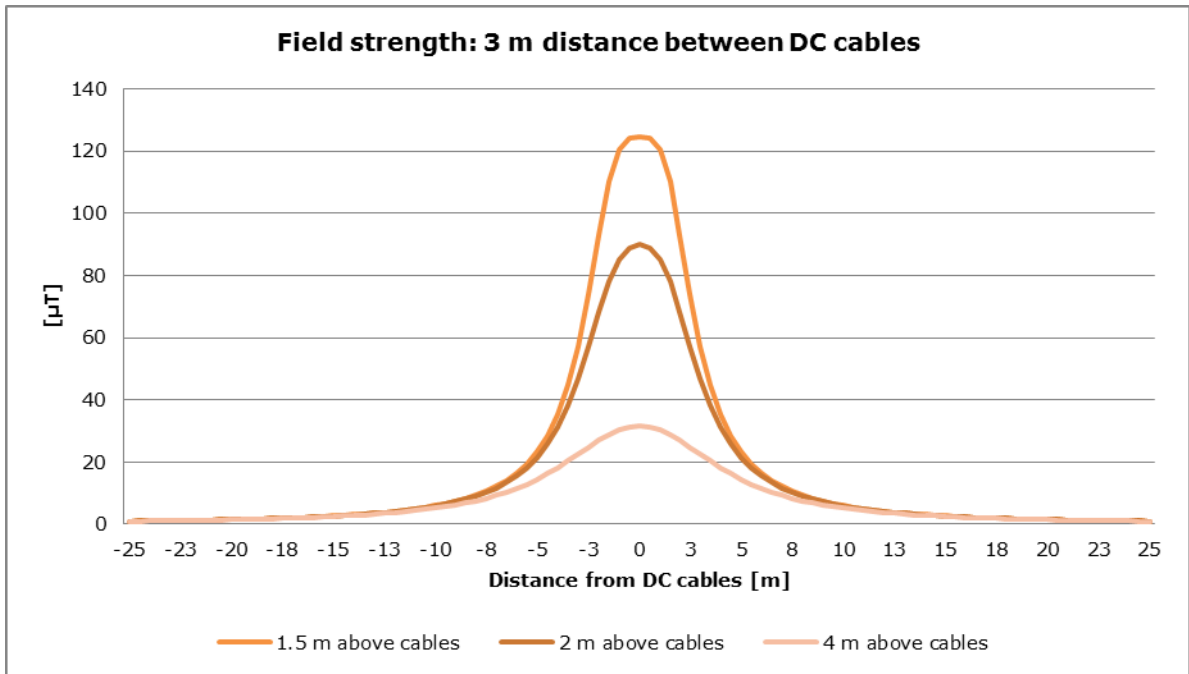

Figure 6.8 - EMF development at different vertical depths above DC cables

Figure 6.8 shows the EMF development from the DC cables during operation. The distance between the cables equals 20 meter.

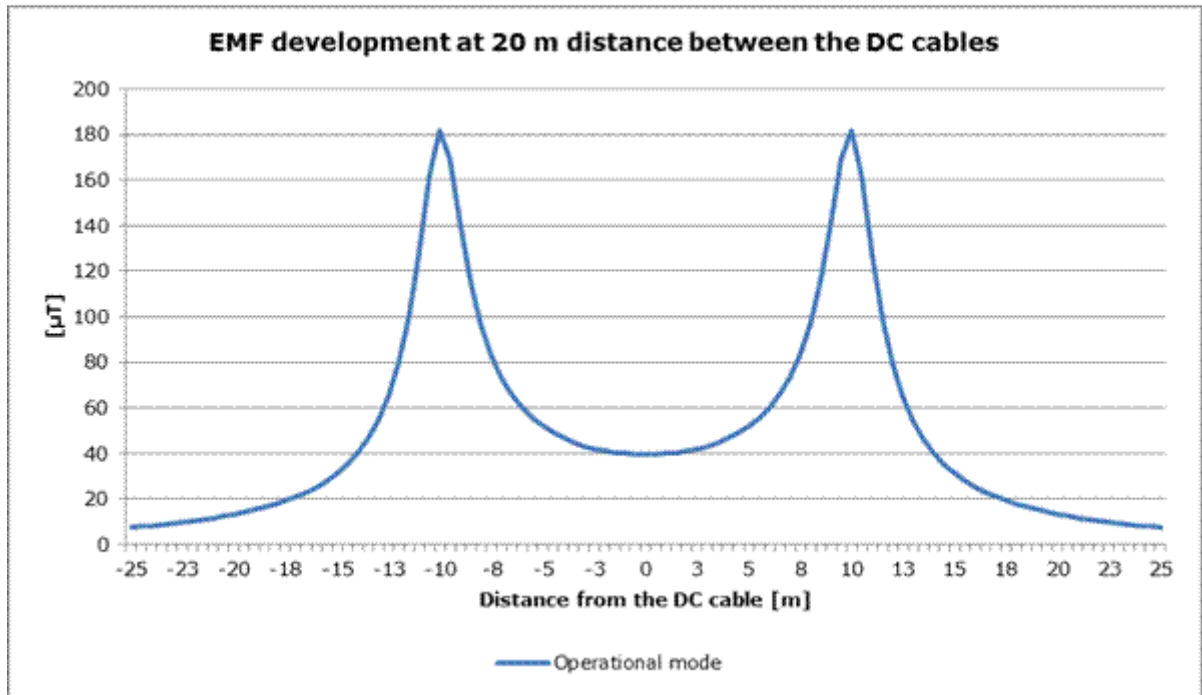

Figure 6.9 - EMF development, 1 m above the DC cables during operation with 20 meter distance between the two cables

The EMF development from the two DC cables during fault mode is presented in figure 6.10. The distance between the DC cables is still 20 meter.

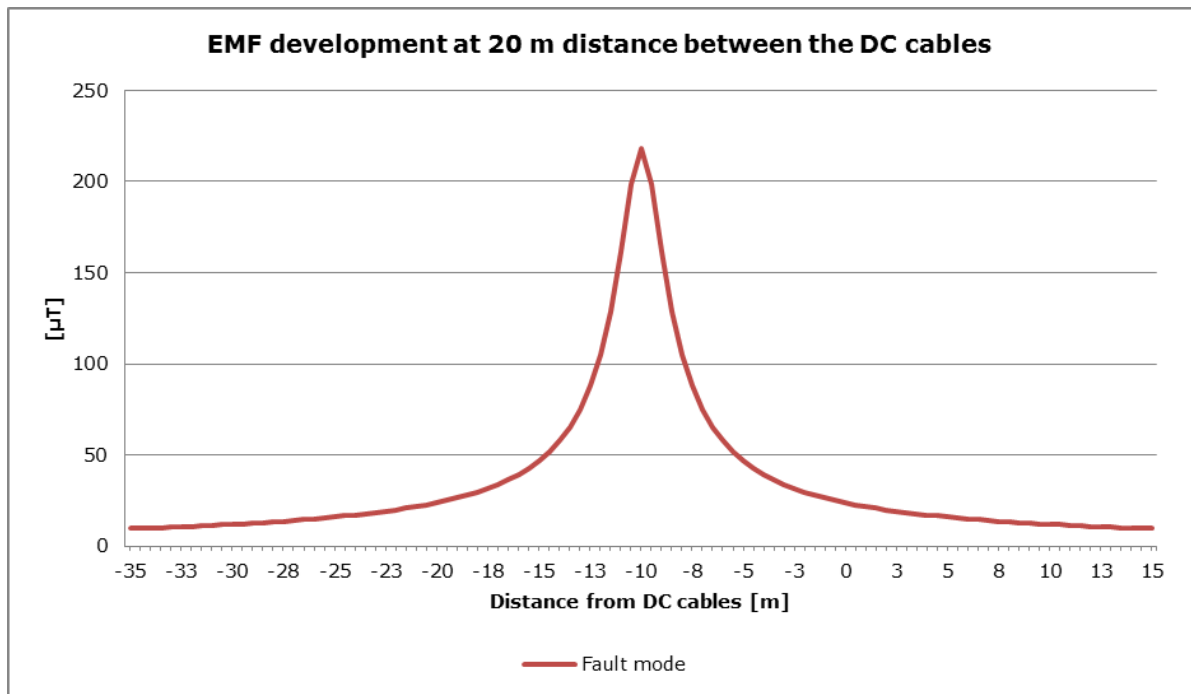

Figure 6.10 - EMF development from the DC cables during fault mode with 20 m distance between the two cables

Figure 6.10 illustrates the EMF development from the two DC cables during operational and fault mode at a 100 meter distance between the two cables. There will still be two peaks during operational mode. Since the situation will be the same for both cables, only one of the peaks is shown in figures 6.10, 6.11 and 6.12.

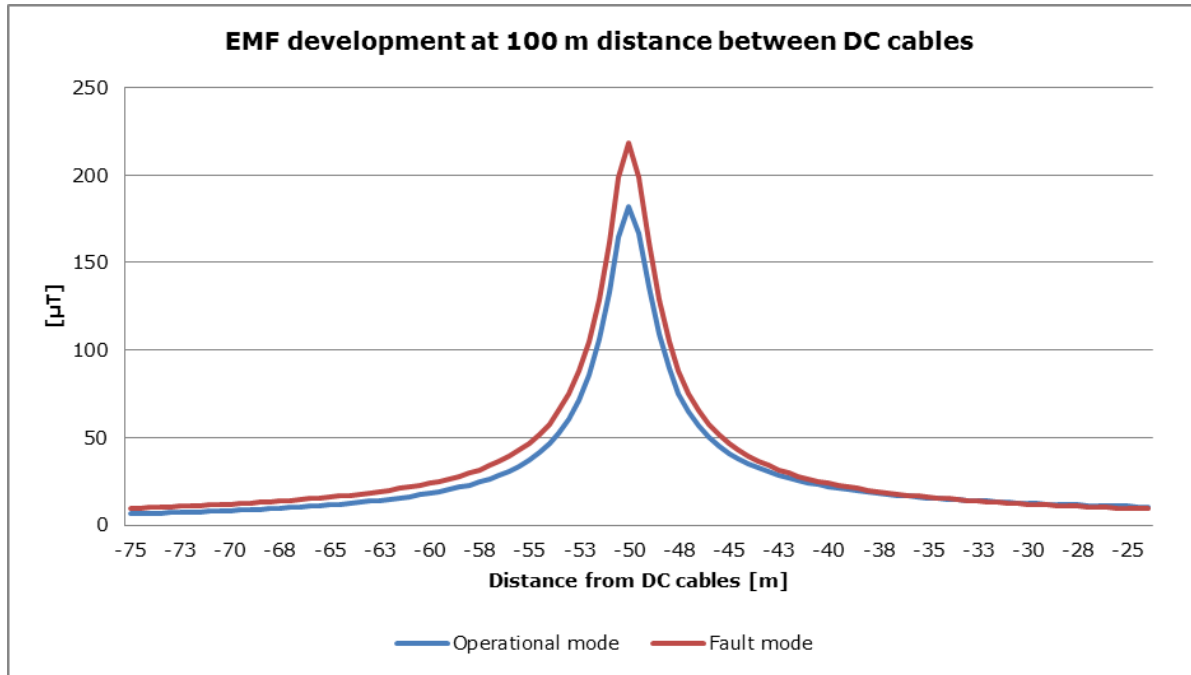

Figure 6.11 - EMF development from the DC cables during operation and fault mode with 100 m distance between the cables

The EMF development during operation of the two DC cables is shown in figure 6.11. The distance between the two cables is 1000 meter.

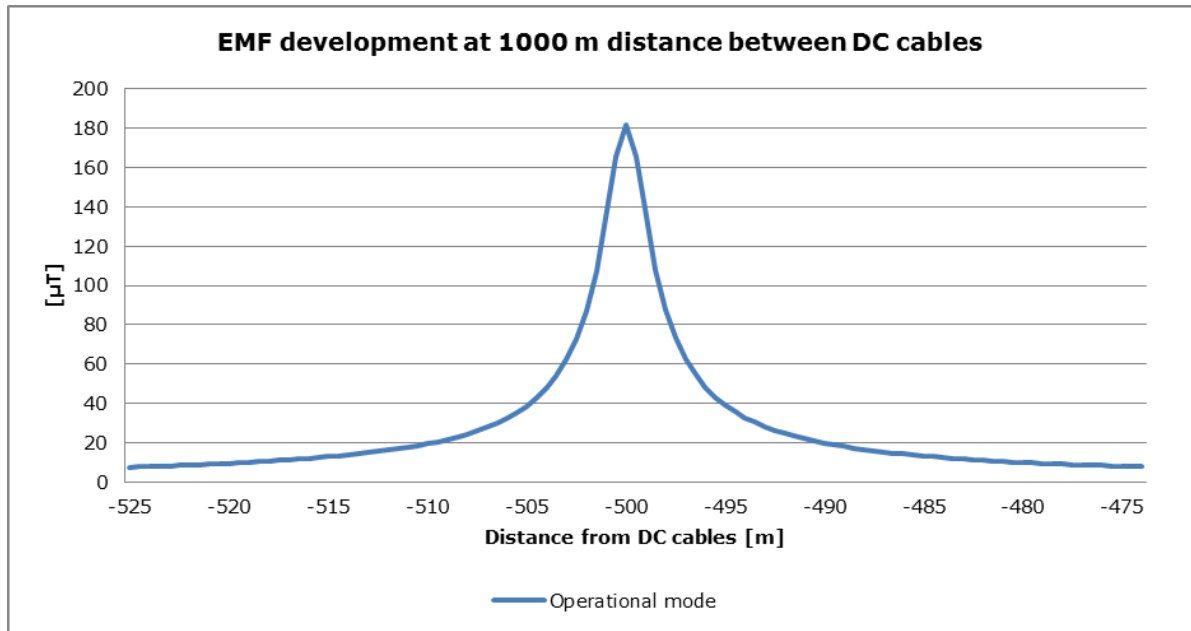

Figure 6.12 - EMF development the DC cables during operation with 1000 m distance between the cables

Figure 6.12 presents the EMF development from the two DC cables during operational mode with 4000 meter distance between the two cables.

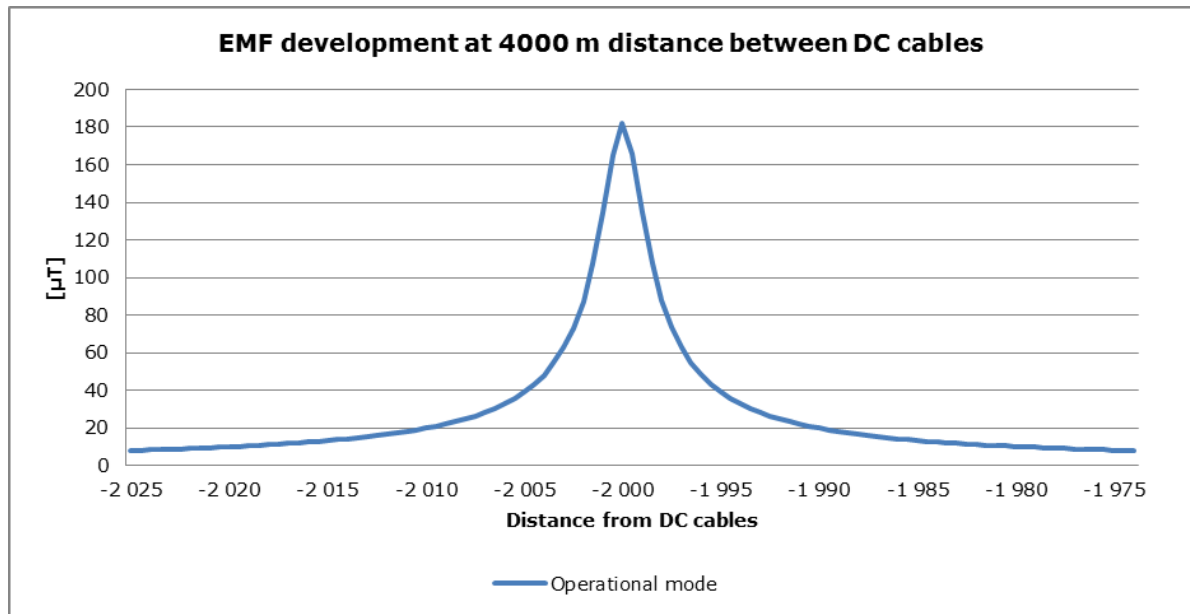

Figure 6.13 - EMF development from the DC cables during operation with 4000 m distance between the cables

6.2.5 Cable riser to Utsira UHPH DC/AC converter

The result is equal to that of section 6.2.3 AC/DC onshore AC/DC Converter station to seabed in normal operation, as the same base assumptions apply except for no cable burial which implies that the vertical levitation may be shifted 0.6 m downwards.

For a fault condition, the result is equal to the fault condition of section 6.2.2 Onshore AC/DC Converter station Haugsneset.

6.3 Compass deviation (declination)

6.3.1 Main assumptions and comments

- The compass deviation is based on calculated HVDC cables horizontal component and the horizontal component of the geomagnetic field.
- An estimated geomagnetic field for the city Stavanger is used, which according to the US NGDC (National Geophysical Data Centre) equals approximately 50.7 μT with an declination of $0^\circ 18' 21'$ east on the 18.06.2013. The estimation is performed using the IGRF11 model provided by The International Association of Geomagnetism and Aeronomy (IAGA).
- Due to the fact that the two cables of the bipole HVDC supply system carry a current of opposite direction, the compass deviation will change direction depending on from which side of the cable the compass is situated. In the middle between the cables the deviation will tend to zero deviation in normal operation. Maximum deviations will be directly above the cables.
- The compass deviation will be unsymmetrical as long as the HVDC cables are not perfectly aligned to the magnetic north-south or east-west due to the north-south component of the generated magnetic field. In the following results, the cable (current) direction of train 1 will be denoted φ which is the angle from true north and the train 2 cables will be parallel and the current direction shifted 180° .
- The cable depth in the following results is representative for the cable of train 1, assuming both cables are laid equally in the horizontal plane.

6.3.2 Results

In the following results the cable depths are relevant to the cable section investigated.

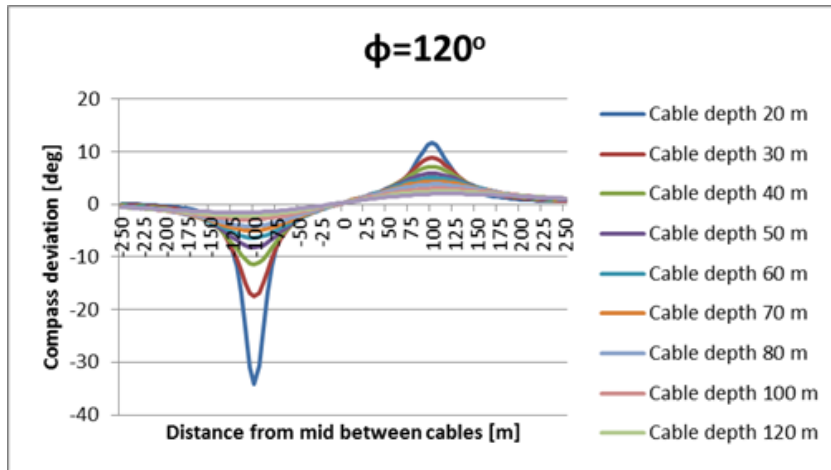

Figure 6.14 - Compass deviation for the first ~1000 m from shore during normal operation

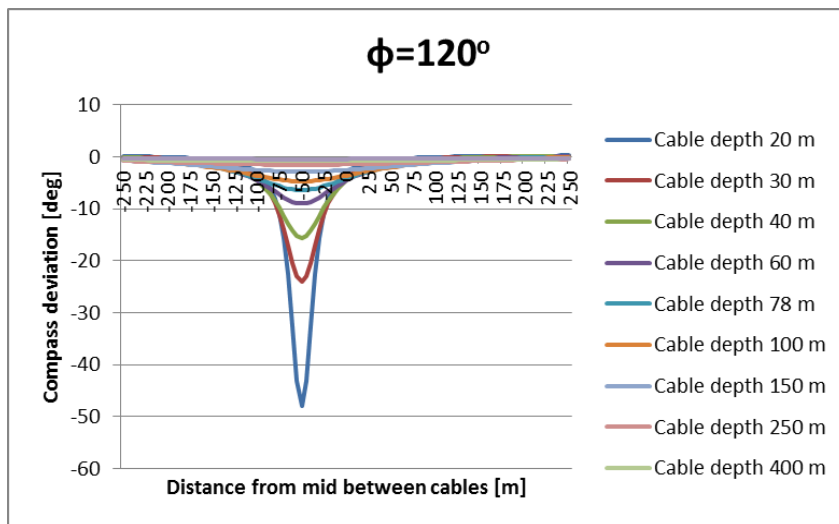

Figure 6.15 - Compass deviation for the first ~1000 m from shore if fault on one train.

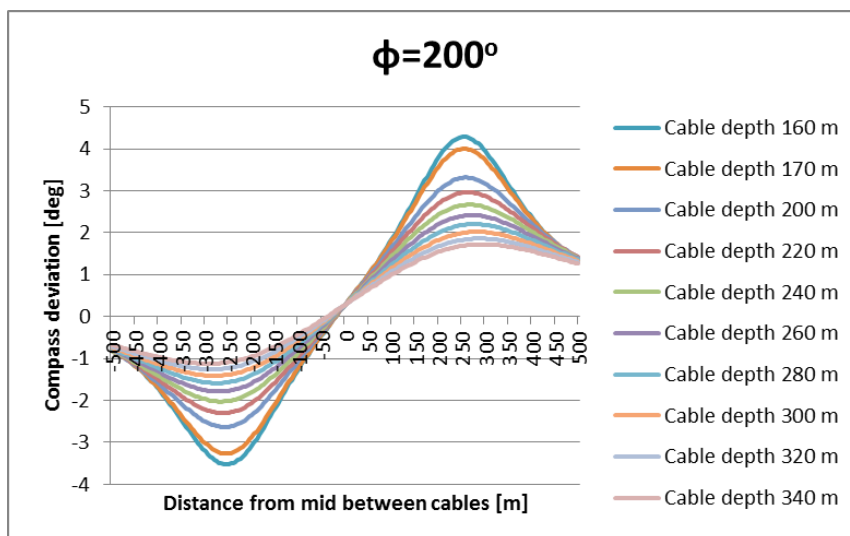

Figure 6.16 - Compass deviation for ~1000-3000 m from shore in normal operation

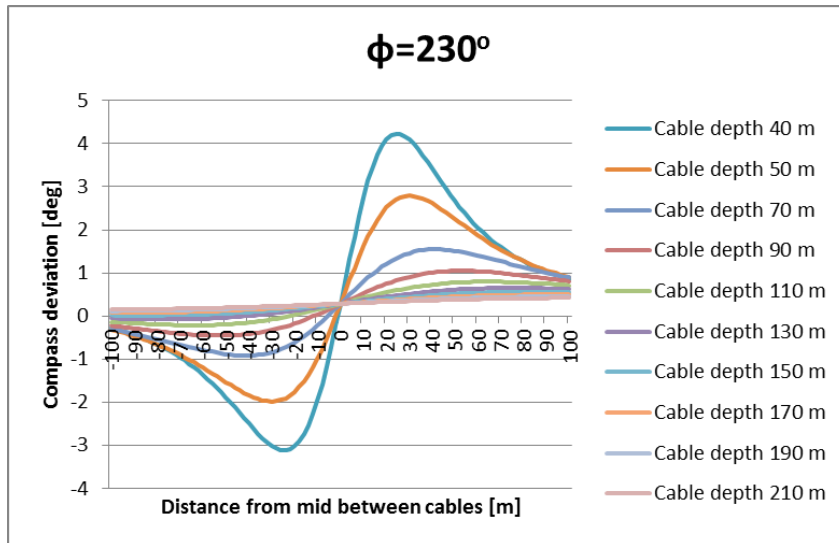

Figure 6.17 - Compass deviation for ~3000-4000 m from shore in normal operation

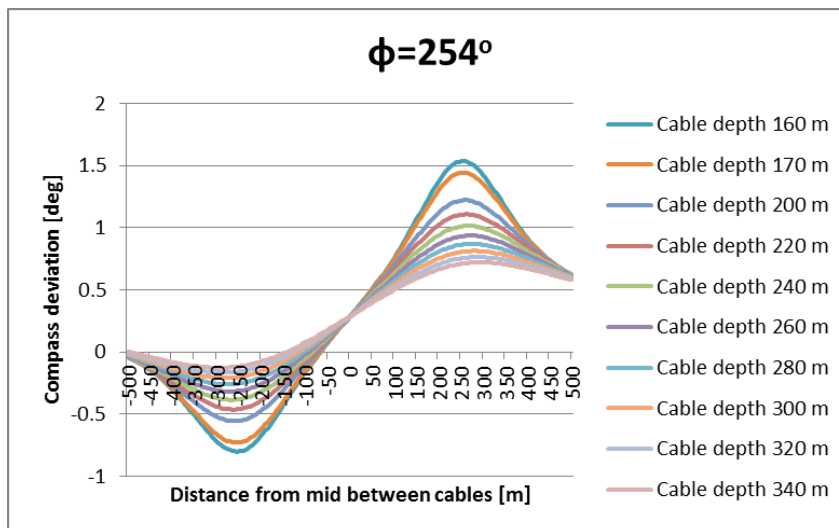

Figure 6.18 - Compass deviation for ~4000-7000 m from shore in normal operation

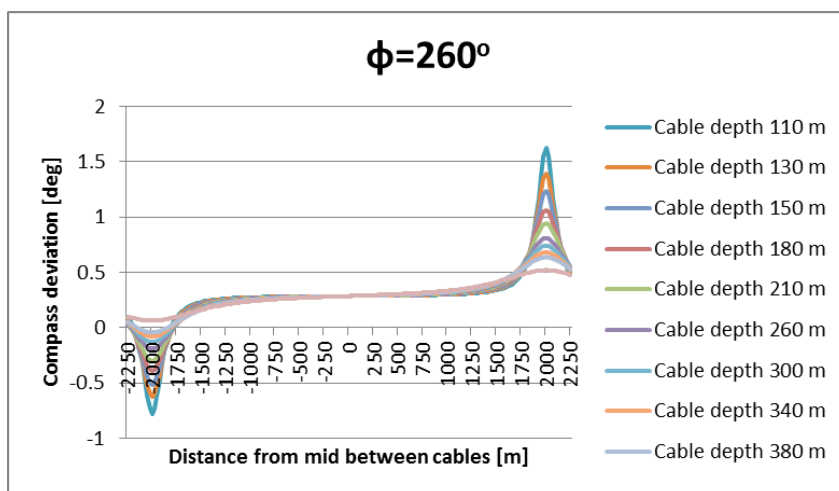

Figure 6.19 - Compass deviation from ~7000 m from shore to close to UHPH in normal operation

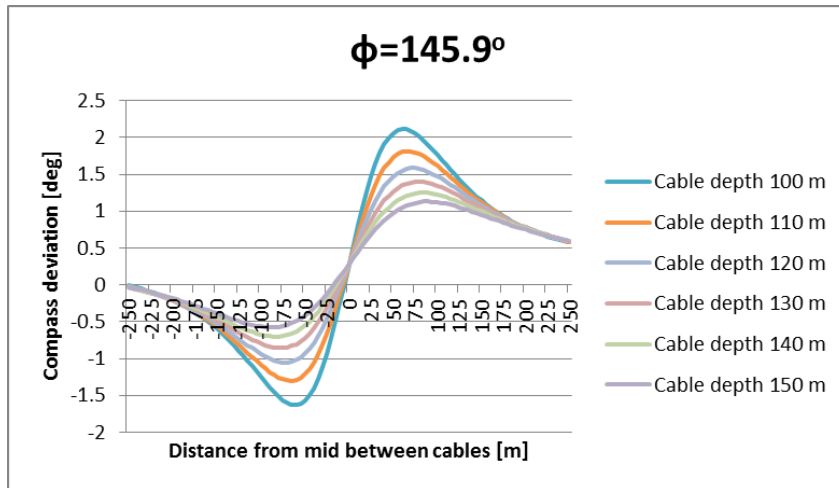

Figure 6.20 - Compass deviation at UHPH approach in normal operation

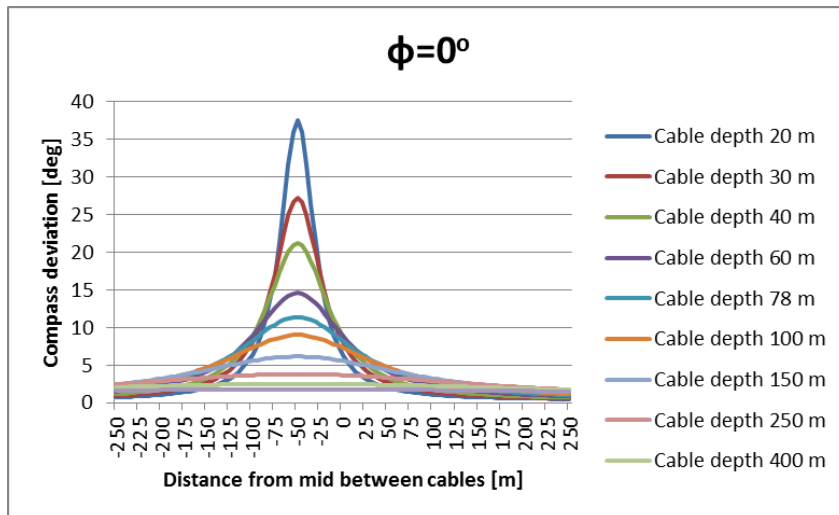

Figure 6.21 - Compass deviation during fault conditions if cables are laid north-south

6.4 AC magnetic fields

6.4.1 Main assumptions

- Other power transmission installations such as the 110 kV and possibly 0.69 kV at Utsira hub represent an uncertainty to the obtained calculated results. A full study should be performed. Influence of other electrical equipment and circuits is not included.
- Cables in trefoil and flat configuration have the phases oriented as in the drawings below.



6.22 - Phase orientation AC cables in trefoil and flat formation

6.4.2 AC supply Haugsneset

This first section consider the area from termination of 420 kV AC cables to train 1 and 2 through the outdoor 420 kV equipment (surge arrester, voltage- and current transformer and possible disconnection switch) which supply the outdoor power transformer (PT). Influence of other sources of magnetic field is not included.

Frequency: 50 Hz
 Distance HV-equipment train 1-train 2 ~40 m

Distance phase-phase: 5 m
 Distance phase-ground: ~7 m (min. 5 m)
 Distance termination-PT: ~40 m

AC primary voltage level: 420 kV (currently 300 kV supply from Kårstø)
 Maximum primary current:
 - Normal conditions ~321 A at 300 kV, $\cos \phi = 0.9$
 - Fault conditions ~385 A at 300 kV, $\cos \phi = 0.9$

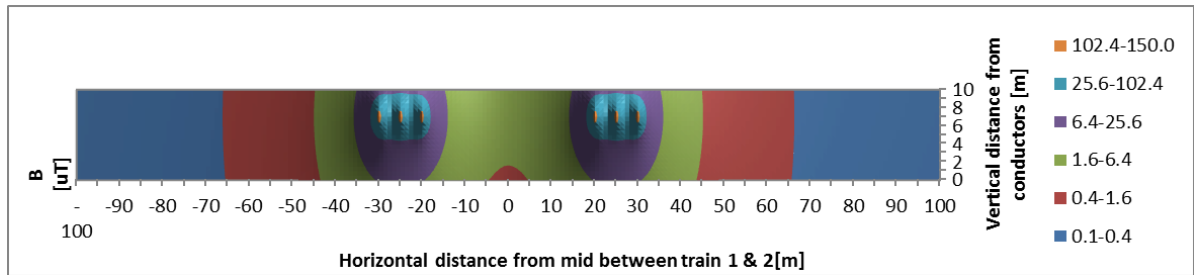

Figure 6.23 - AC supply to power transformer at converter station onshore, normal operation

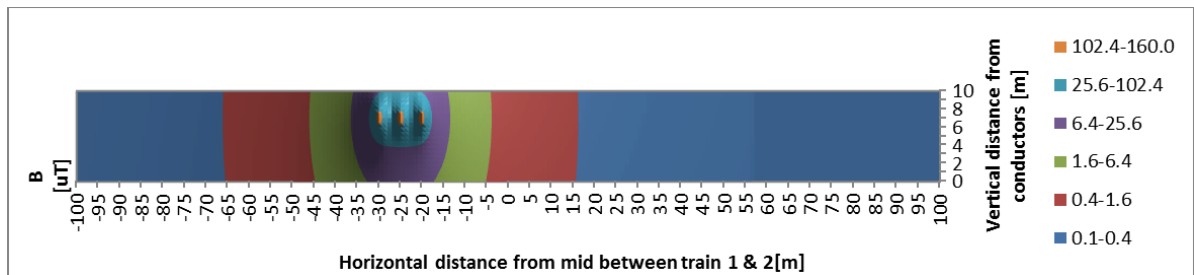

Figure 6.24 - AC supply to power transformer at converter station onshore, fault condition

The below figures of this second section comprise the secondary voltage supply to AC hall and to AC reactor hall. There will be one set of single core 1000 mm² CU cables for each train rated 145 kV. Except for the equipment connections, cables are assumed to be laid as a trefoil. Influence of other sources of magnetic field is not included.

Frequency: 50 Hz
 Distance phase-phase: ~2 m (at transformer/equipment bushing)
 ~87 mm (equals outer diameter of cables in trefoil)

AC secondary voltage level: 97 kV
 Maximum secondary current:
 - Normal conditions: ~992 A at 97 kV, $\cos \phi = 0.9$
 - Fault conditions: ~1 190 A at 97 kV, $\cos \phi = 0.9$

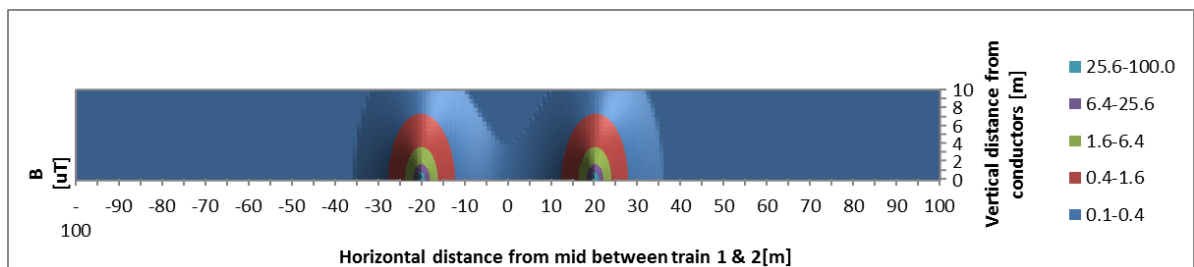

Figure 6.25 - AC supply from power transformer at converter station onshore, cables in trefoil, normal operation

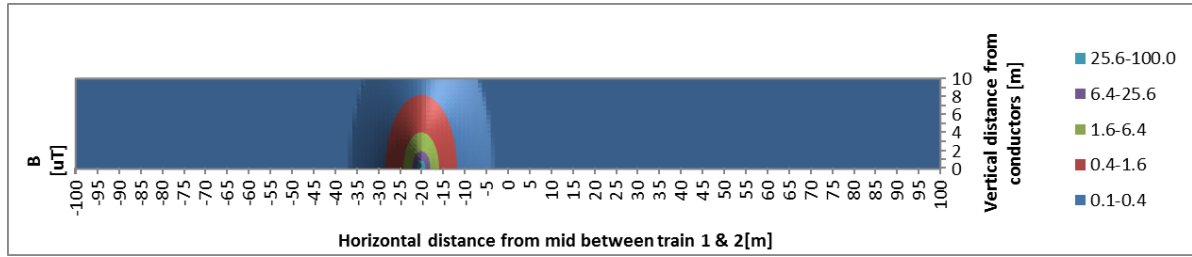

Figure 6.26 - AC supply from power transformer at converter station onshore, cables in trefoil, fault condition

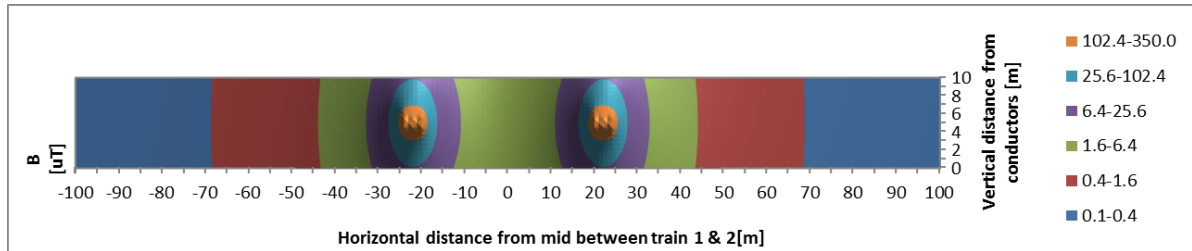

Figure 6.27 - AC power transformer bushing, converter station onshore, normal operation

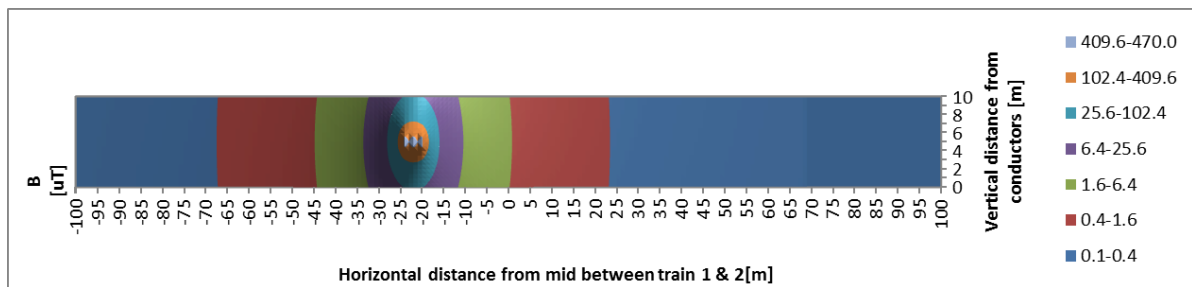

Figure 6.28 - AC power transformer bushing, converter station onshore, fault condition

6.4.3 AC supply UHPH

The below figures comprise the secondary AC voltage supply from DC valves to hub transformers. There will be one set of three 1000 mm² CU cables for each train rated 145 kV. Except for the equipment connections, cables are assumed to be laid as a trefoil. Influence of other sources of magnetic field is not included.

Distance between cables and connections of train 1 and 2 evaluated to be approximately 17 m /31/.

- Frequency: 50 Hz
- Distance phase-phase: ~2 m (at transformer/equipment bushing)
~87 mm (equals outer diameter of cable in trefoil)
- AC primary voltage level: 92 kV
- Maximum primary current:
 - Normal conditions: ~1 046 A at 92 kV, cos φ = 0.9
 - Fault conditions: ~1 255 A at 92 kV, cos φ = 0.9

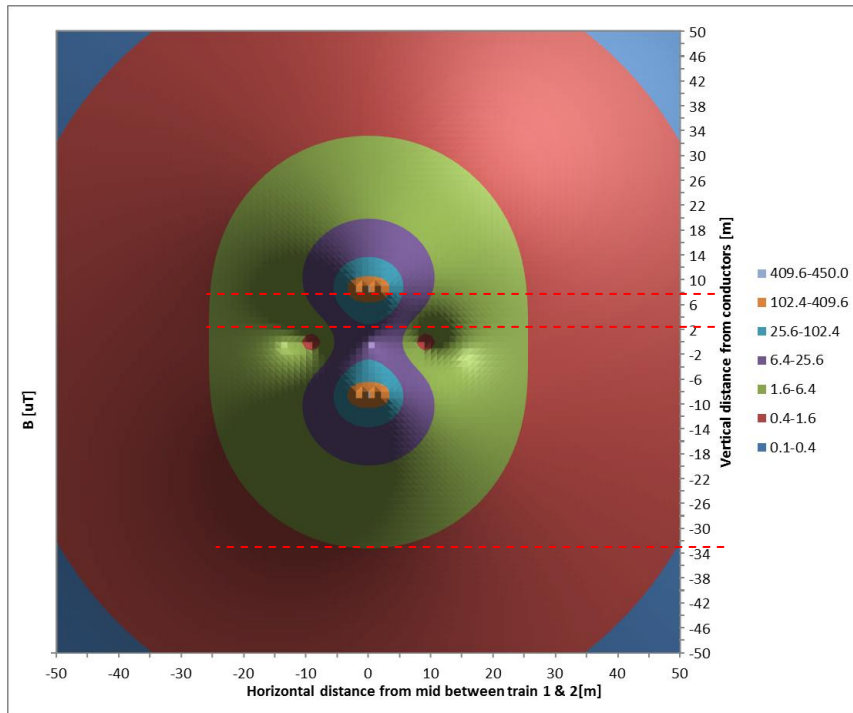

Figure 6.29 - UPH AC power transformer bushing, normal operation

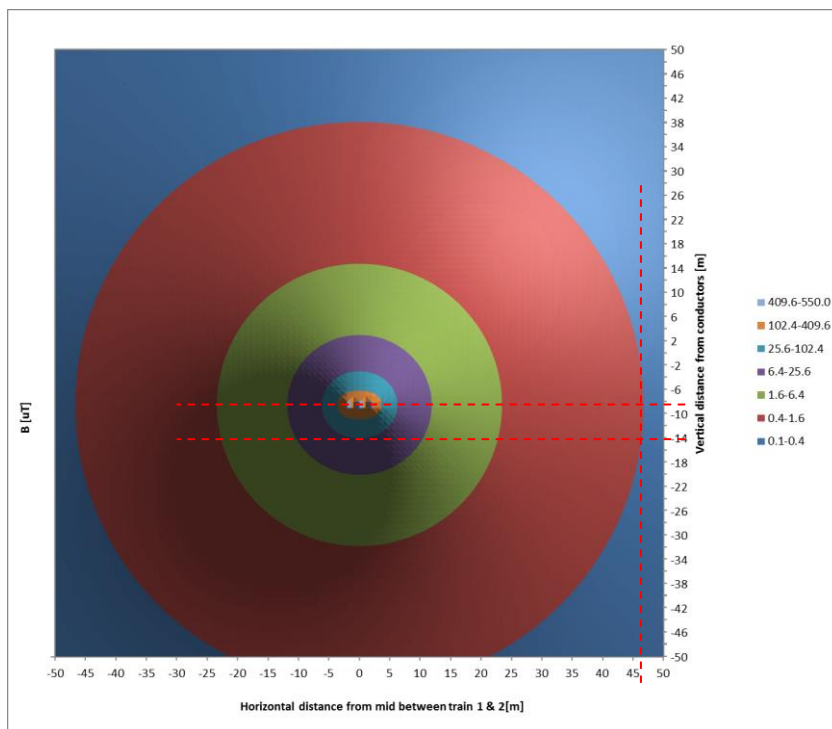

Figure 6.30 - UPH AC power transformer bushing, fault condition

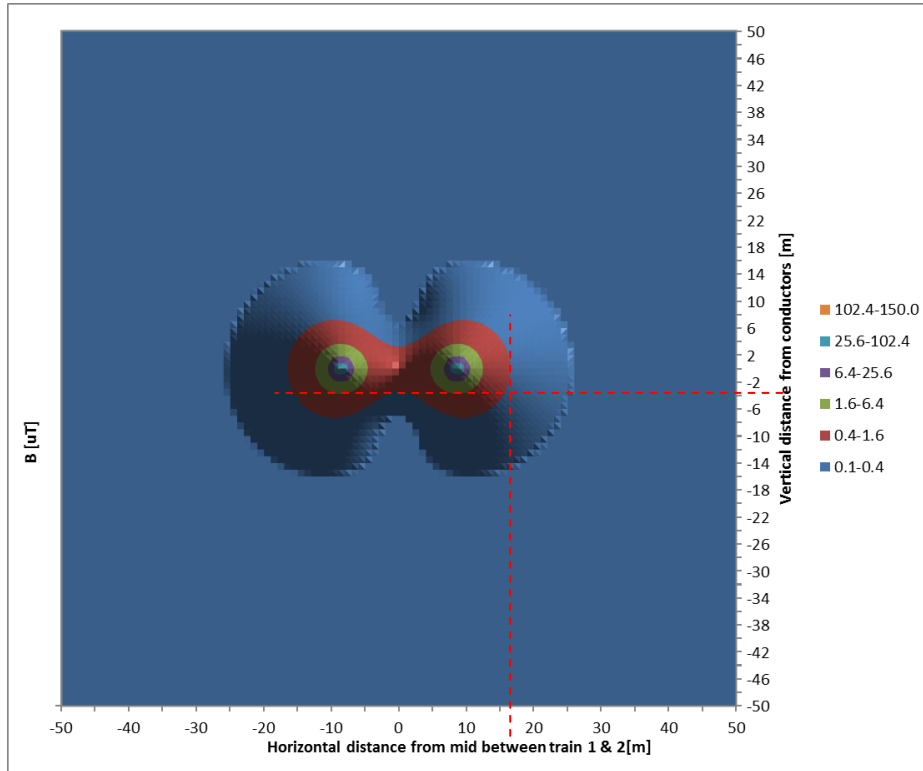

Figure 6.31 - UHPH AC supply from DC valves, cables in trefoil, normal operation

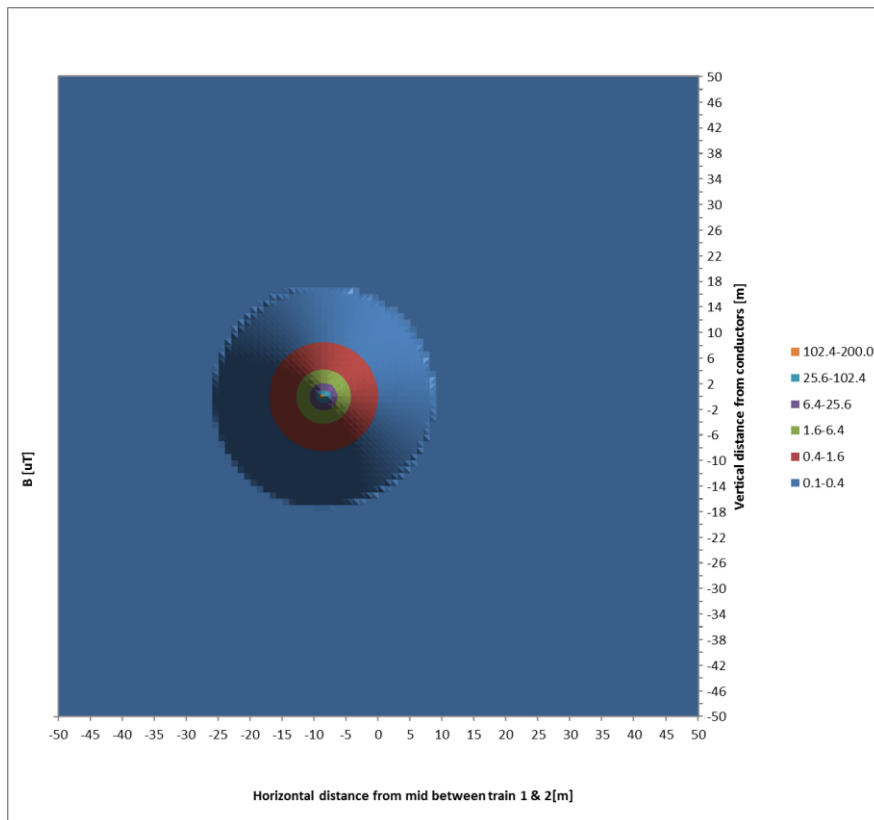

Figure 6.32 - UHPH AC supply from DC valves, cables in trefoil, normal operation

6.4.4 Utsira UHPH 33 kV offshore

Transformers supply 110 kV and 33 kV from the transformer, the latter being the scope of this study.

It is assumed that all switchgear within the 33 kV distribution network are of ABB GIS type ZX2 without instrument transformer, panel with 600 mm, spacing between cable connection 150 mm.

Regarding cables the number of parallel circuits has been evaluated in appendix 1. The total width of the cables installed in the horizontal plane will be approximately 2.75 m. The AC cables from the 33 kV GIS assembly at the Utsira hub are expected to be routed to a cable bridge outside of the hub and follow this to the connecting bridge. The cables will be routed either above or below area accessible to people/transport, marked red and blue as shown in the figure below. The amount of other infrastructure as telecom and piping may be substantial, but the final outline is not known. Considering the bridge structure dimensions, it is assumed that the 33 kV trefoil cable sets may be laid side-by-side.

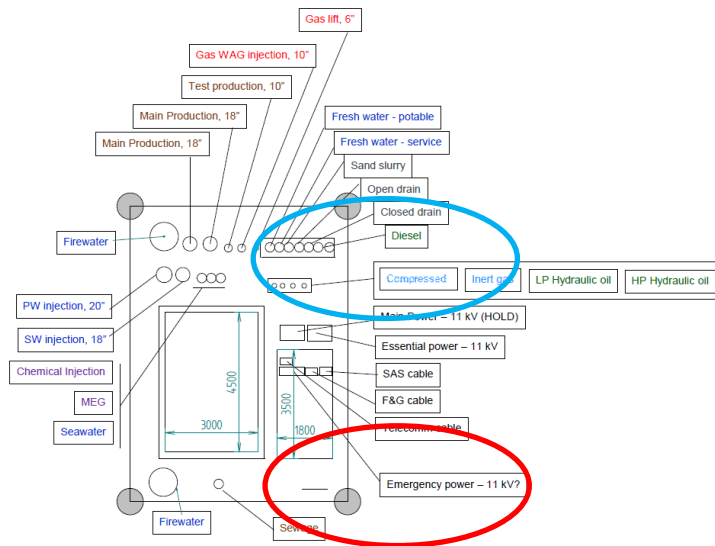

Figure 6.33 - Preliminary cross section drawing of bridge to Johan LQ platform /34/

Frequency:	60 Hz
Distance phase-phase:	cable diameter (except GIS-connection)
- 300 mm ² CU	~47 mm
- 240 mm ² CU	~44 mm
Distance between sets of cables:	150 mm
AC voltage level:	33 kV
Maximum current:	
- 300 mm ² CU	~350 A (60 MVA, 3 sets of cables per circuit)
- 240 mm ² CU	~280 A (16 MVA, 1 set of cables per circuit)

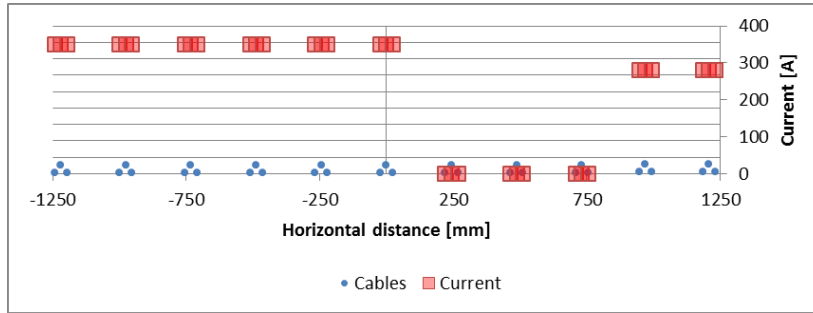

Figure 6.34 - 33 kV AC cable layout and current flow UHPH and bridge

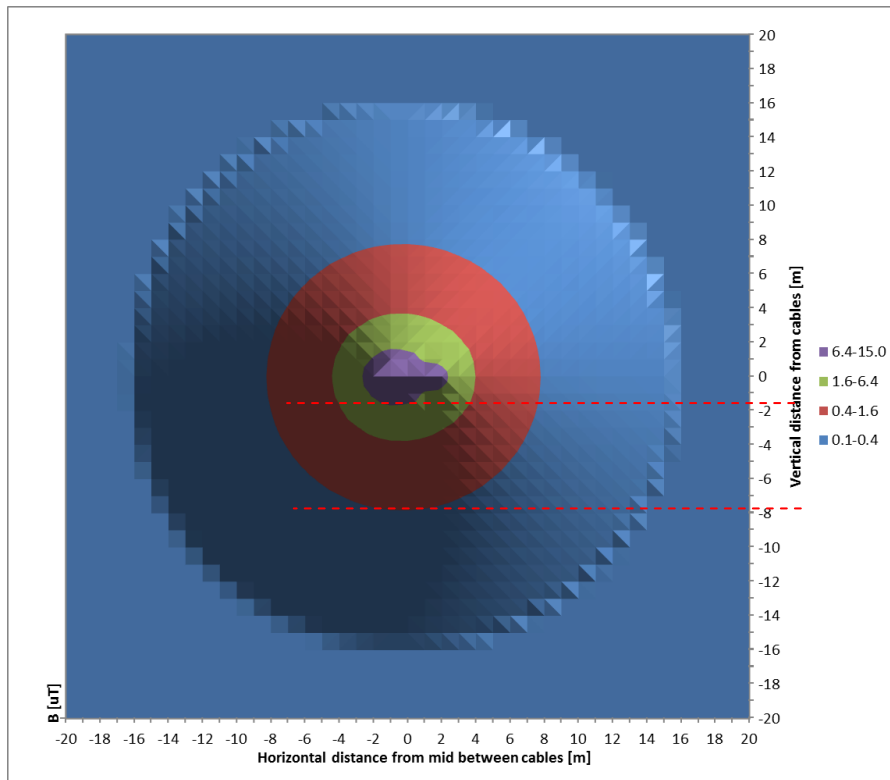

Figure 6.35 - Magnetic field distribution from 33 kV AC cables at UHPH and bridge

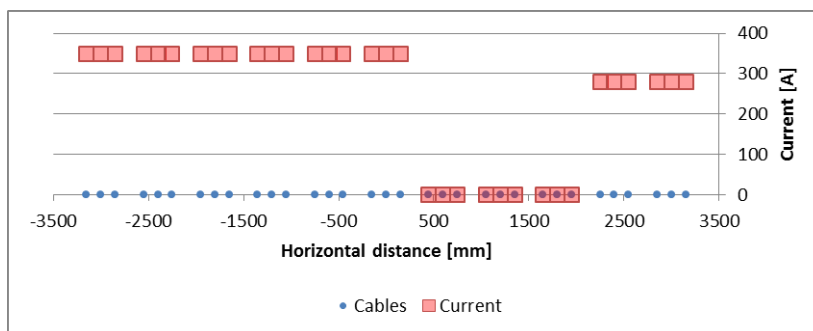

Figure 6.36 - 33 kV AC cable GIS termination UHPH

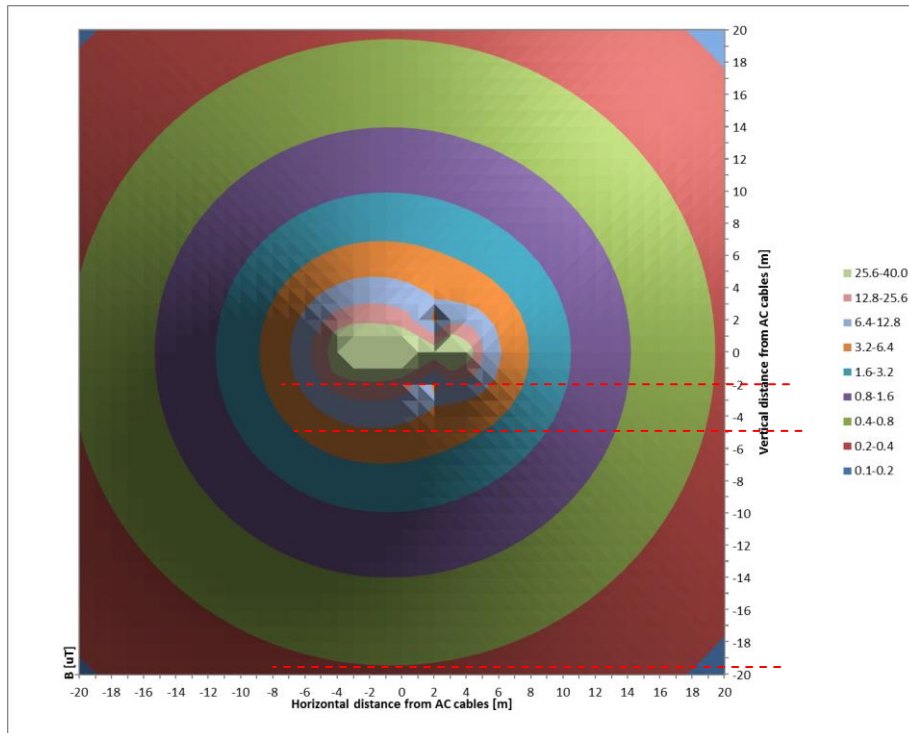

Figure 6.37 - Magnetic field distribution 33 kV GIS at UHPH

6.4.5 Johan Sverdrup 33 kV

The 33 kV AC cables from the bridge which is to be connected to the Johan LQ platform are expected to be routed on a cable bridge outside of the main structure and follow this to the GIS switches. There will be one set of cables per circuit connecting to Johan LQ

Frequency:	60 Hz
Distance phase-phase:	cable diameter
- 240 mm ² CU	~44 mm
Distance between sets of cables:	150 mm
AC voltage level:	33 kV
Maximum current:	~280 A (16 MVA, 1 set of cables per circuit)
- 240 mm ² CU	

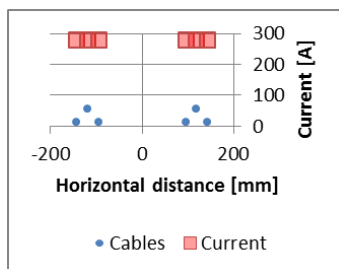

Figure 6.38 - 33 kV AC cable layout and current flow

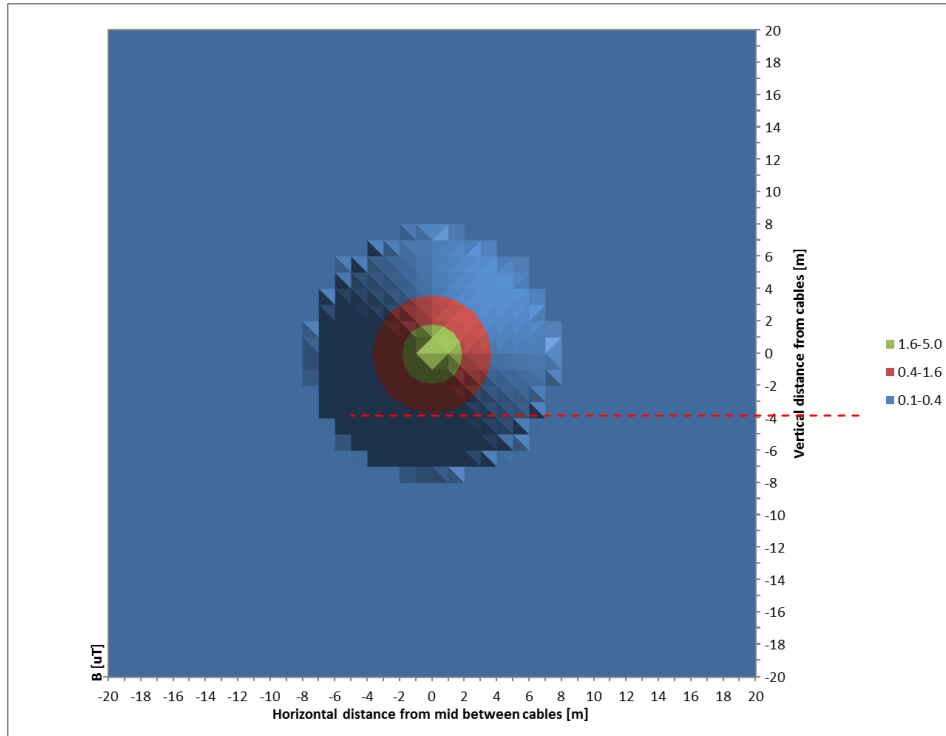

Figure 6.39 - Magnetic field distribution from 33 kV AC cables at Johan Sverdrup

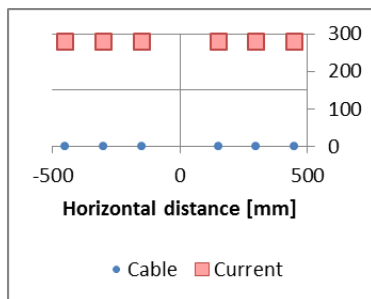

Figure 6.40 - 33 kV AC cable GIS termination Johan Sverdrup

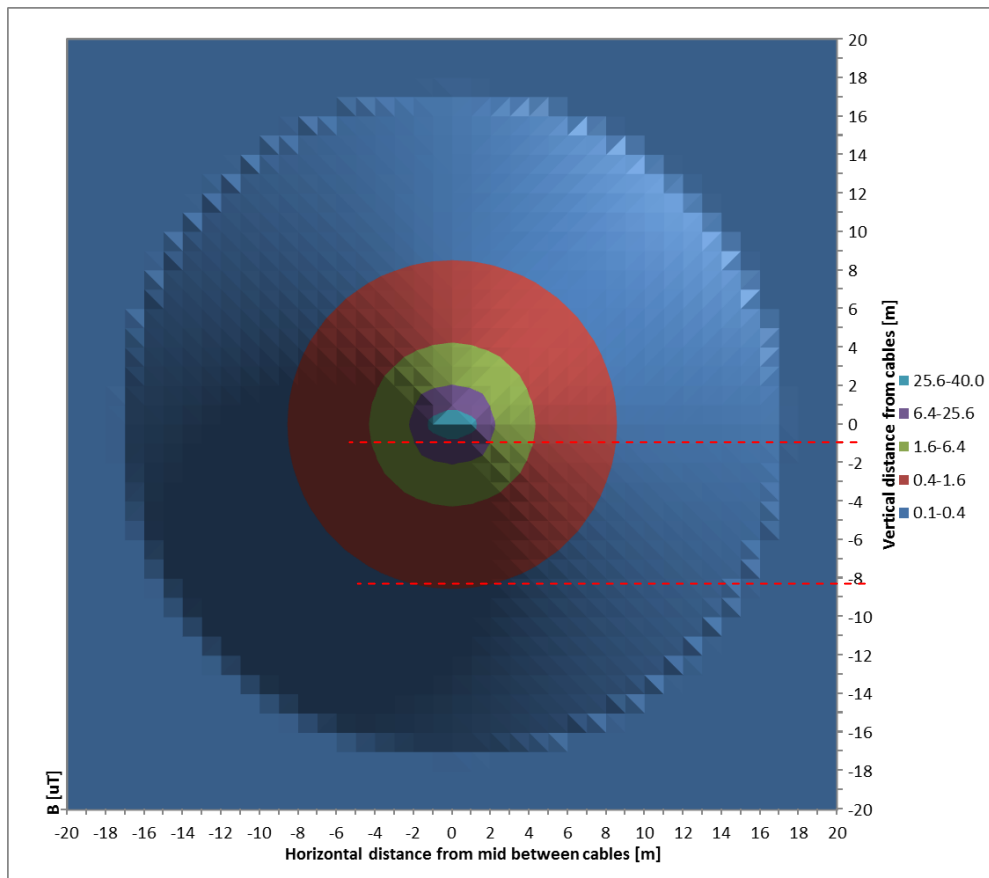

Figure 6.41 - Magnetic field distribution 33 kV GIS at Johan Sverdrup

6.5 Electrical equipment as sources of magnetic field

6.5.1 General considerations

The magnetic field surrounding electrical equipment is challenging to predict due to the complexity, of specific equipment design and the mutual influence from multiple objects on the field distribution. This is beyond the scope of this assessment.

As a general remark, compared to AC cables where the magnetic field is reduced by approximately the square of the distance (r^2) from the cables, for electrical equipment with closed loops such as the transformer and AC-motor the reduction is approximately r^3 .

For the converter station equipment which will be utilized connecting UHPH to shore, the EMF hazard and shielding options should be documented by supplier upon request to comply with the exposure level limits.

6.5.2 Transformer example

An evaluation of the magnetic field strength of a 250 MVA 300 kV transformer and a 220 MVA 240 kV transformer has been performed by L. Strac et al. in /35/. These transformers may yield similar results as the converter transformers at Haugsneset and UHPH. The magnetic field (denoted magnetic induction in the below figures) is investigated from four sides as depicted in the drawings below.

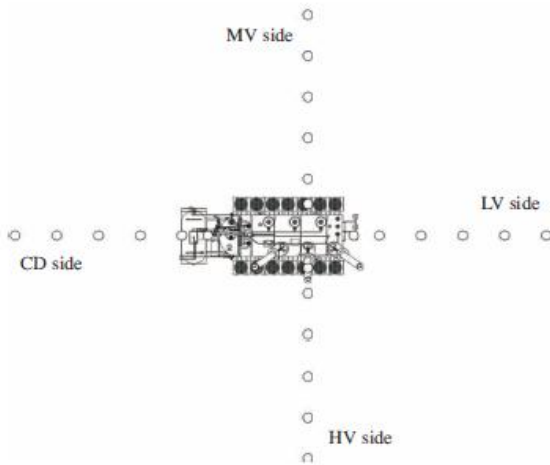

Figure 6.42 - Top view of 250 MVA transformer and field strength measurement points /35/

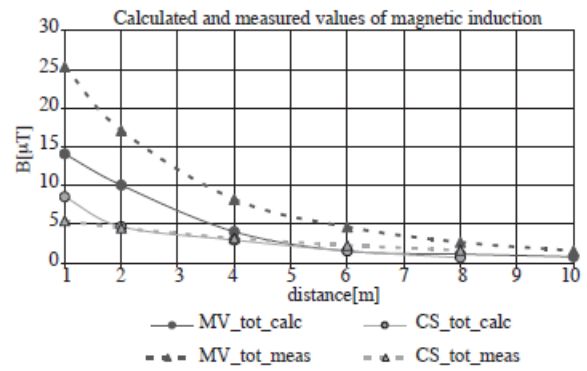
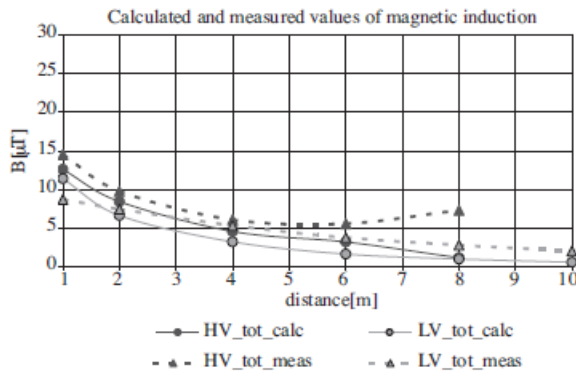

Figure 6.43 - Calculated and measured magnetic field for 250 MVA 300 kV transformer /35/

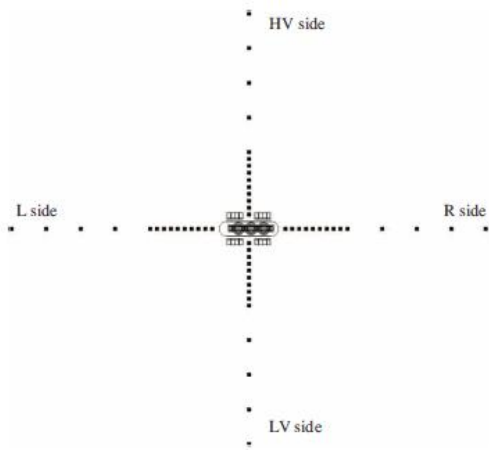

Figure 6.44 - Top view of 220 MVA transformer and field strength measurement points /35/

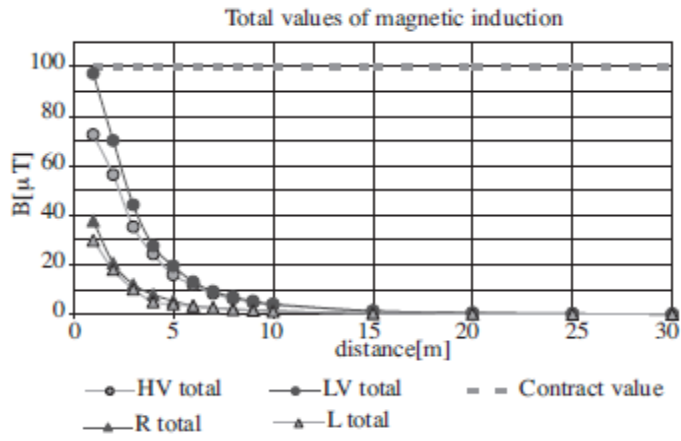

Figure 6.45 - Calculated magnetic field for 220 MVA 240kV transformer /35/

7. ASSESSMENT OF HUMAN EXPOSURE RISK

7.1 Introduction

7.1.1 Exposure definition

Exposure may be defined as “the contact of a chemical, physical, or biological agent with the outer boundary of an organism”. There are four important aspects (main characteristics) for determination of exposure:

- The nature of the agent, e.g., Chemical, physical and biological properties
- The intensity of exposure, i.e., How much (concentration) of the agent?
- The duration of exposure, i.e., For how long a time?
- The frequency of exposure, i.e., How often?

Exposure is quantified as the concentration of an agent in a medium in contact with the human body, averaged or integrated over time (duration) of contact. Various time frames of exposure are:

- Short-term exposure Seconds, minutes, hours, days
- Long-term exposure Weeks, months, years, lifetime
- Cumulative exposure Total exposure over a given period of time

One must distinguish between environmental concentration, exposure concentration, and dose.

- The environmental concentration of an agent refers to its presence in a particular carrier medium (for example, PAH in ambient air), expressed in quantitative terms (for example, $\mu\text{g}/\text{m}^3$).
- Similarly, the exposure concentration of an agent refers to its presence in its carrier medium at the point of contact (for example, PAH in breathing zone air) expressed in quantitative terms (for example, $\mu\text{g}/\text{m}^3$).
- Finally, the dose refers to the amount of a pollutant that actually enters the human body, i.e. is taken up through absorption barriers.

The mathematical relationship for exposure as a function of concentration and time can be represented by the equation:

$$E = \int_{t_1}^{t_2} C(t)dt$$

in which E is the intensity of exposure, C(t) is exposure concentration as a function of time, and t₂-t₁ is the duration of exposure.

7.1.2 Scope of exposure assessment

Exposure assessment includes:

- Identification and evaluation of sources of hazardous agents (type, amount released, geographic location)
- Determination of concentrations of agents in environmental media such as air, water, food and soil
- Identification of (major) pathways and routes of exposure
- Determination of intensity, duration and frequency of exposure
- Determination of dose resulting from exposure

- Estimation of number of persons exposed
- Identification of high-risk groups (highly exposed or more susceptible to effects)

7.1.3 Exposure and exposure assessment of electrical power magnetic field

There are some uncertainties about how to define “exposure” from electrical power magnetic field because future studies have yet to show which aspect of the field, if any, may be relevant to reported biological effects. Important aspects of exposure could be the highest flux density, the average flux density, or the amount of time spent above a certain baseline level. One of the most widely used measures of EMF exposure has been the time weighted average magnetic field level.

7.2 Exposure assessment of HV AC/DC onshore conversion substation and landfall

7.2.1 Description of area:

Drawing below shows the Utsira HPH AC/DC onshore conversion station in Haugsneset (ref. /27/). The area is fenced off, i.e., no access for general public. According to the drawing the area allocated to the substation is about 135 m long and 95 m wide. The minimum distance between HV areas inside the conversion building walls and fences is about 15 m. DC cables leave the restricted area from the south-east corner. Drawing shows no fences to restrict the area for public access.

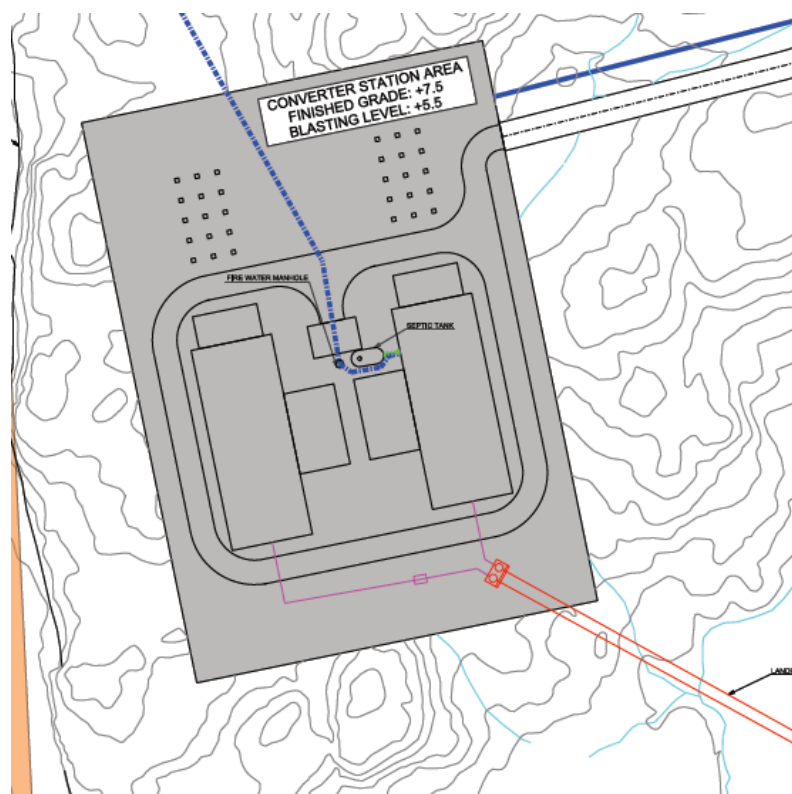

Figure 7.1 - AC/DC converter station area (ref. 27/)

As shown in drawing below, this facility consists of two identical buildings accommodating AC/DC conversion train 1 and 2. Since these conversion trains are identical, only one of the trains is discussed further.

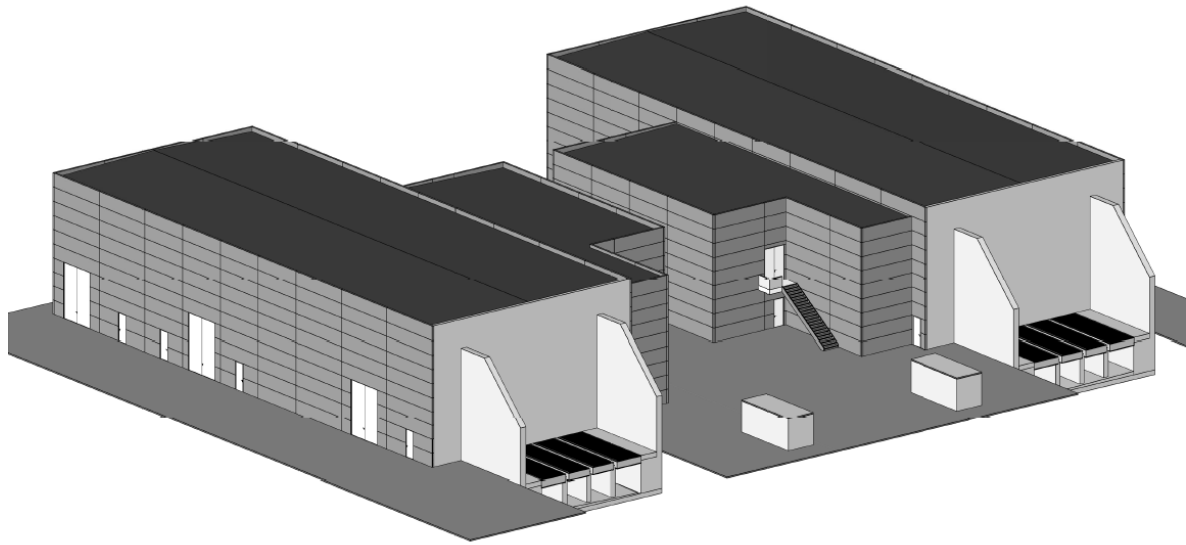

Figure 7.2 - 3D view of conversion substation

Following drawings from ref. /29/ and /30/ show which areas in the conversion train buildings are regarded as HV areas with assumedly access restriction (marked by red colour) and non-restricted areas during operation (marked with green colour). There are two HV feeder/supply transformers at the front of the buildings.

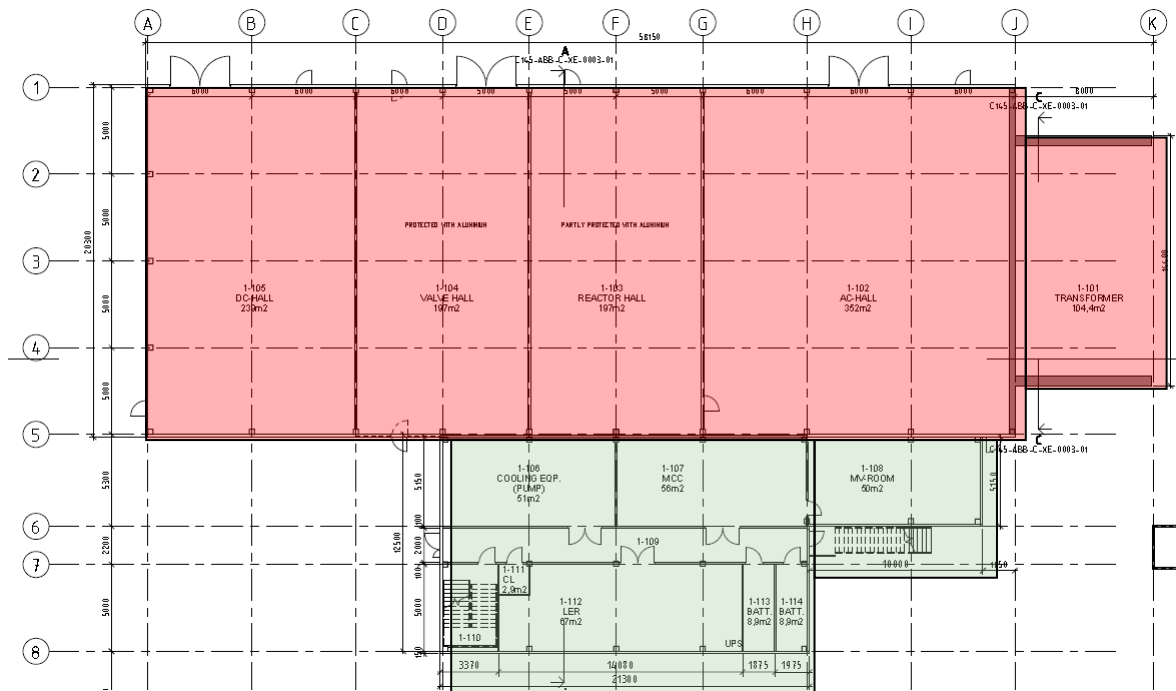

Figure 7.3 - Conversion train building – plan level 1 (ref. /29/)

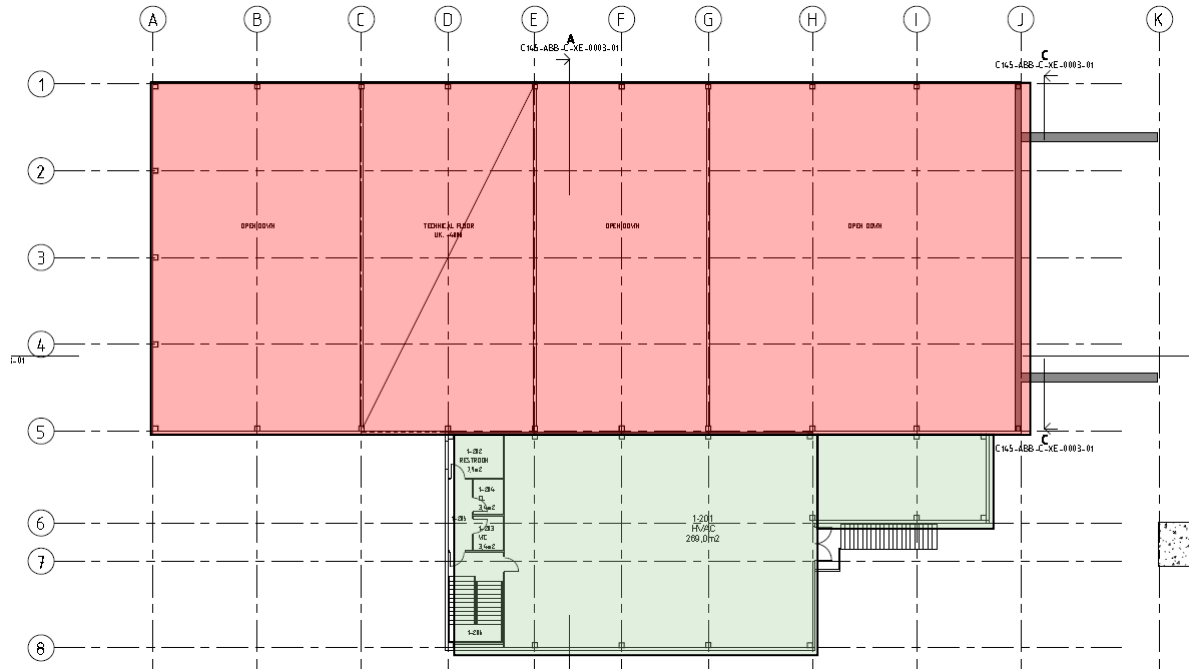

Figure 7.4 - Conversion train building – plan level 2 (ref. /30/)

As drawings shows, cooling equipment room, MCC and MV rooms are adjacent to the HV room in level 1 and HVAC and rest room in level 2.

It is assumed that there is a work station in LER in level 1 for use of vendor's staff. Distance between LER and conversion train hall is about 7 m.

Drawing below shows HV AC power supply cables within substation facility area.

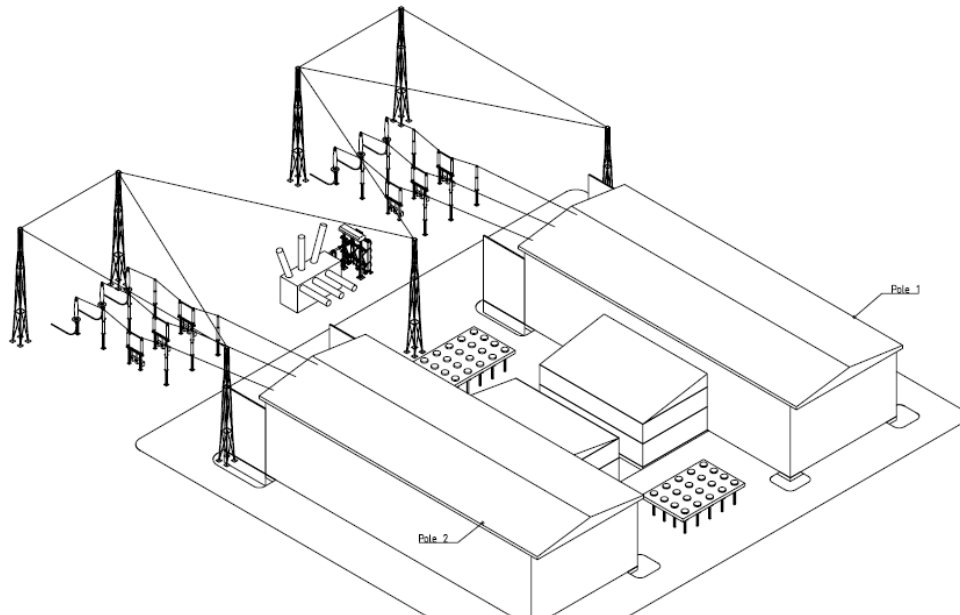

Figure 7.5 - Onshore conversion substation (ref. /38/)

7.2.2 Planned safety barriers

Doors interlock system

According to ref. /10/, it is not allowed to enter the high voltage areas (AC and DC) during operation. All doors to IGBT and reactor areas are equipped with a lock system that is integrated to a

key interlocking system in order to prevent access when the Converter system is energized. Safety shutdown logic should be designed in this regards. The purpose of the key interlocking system is to ensure safety for personnel during maintenance and/or inspection. Access to a high voltage area is only permitted when the equipment in the area is earthed. Consequently it is not permitted to open/remove earthing devices as long as access to the area is permitted.

Faraday cage – not a barrier for ELF EMF

According to ref. /10/, the basic EMC principle for the HVDC Converter is to control the high frequency current and voltage so that they are not spread out. The same principle as for the Faraday cage shall be adopted. The motivation is for avoiding RI emission from the scheme and for avoiding that high frequency currents “pollute” the surroundings.

Facility fences

Facility fences prevent access of general public to the facility area.

7.2.3 Operation, inspection and maintenance

Following assumptions are made:

- The facility is not permanently manned and is remotely monitored. Thus it is visited when a demand arises or inspection/maintenance routines require such visit.
- The inspections are performed by two persons, based on a weekly routine.
- It is also assumed a monthly demand to visit the station due to alarms or other requests.
- The inspections of HV rooms require work permit and de-energising of rooms – access only by authorized people
- Each inspection covering both trains lasts for 2 hours
- Some of maintenance work can be done during operation
- Maintenance is down four times a year (two times a year for each train)
- Each maintenance lasts for 5 days
- A working shift last for 8 hours
- Vendor's staff can be present in LER rooms for longer period for collection of data and monitoring during their campaigns. It is assumed that they visit the facility twice each year with duration of 5 days each week. Their working shift lasts for 8 hours.
- Start up phase/commissioning is not part of this study/scope

7.2.4 Exposure time

Operational staff:

$$(2 \text{ hrs} \times 52 \text{ weeks}) + (2 \text{ hrs} \times 12 \text{ months}) + (8 \text{ hrs} \times 5 \text{ days} \times 2) = 208 \text{ hrs / yr}$$

Vendor's staff:

$$(8 \text{ hrs} \times 5 \text{ days} \times 2) = 80 \text{ hrs / yr}$$

Assuming that long term exposure means that one person should be exposed at least 1/3 of his daily time in average during a year, i.e., 2920 hrs/yr., then the time durations estimated above could be considered as marginal.

7.2.5 Estimated magnetic flux intensity and exposure

Table 7.1 - DC cables inside and outside substation fenced area

	Investigation level	Reference level for general public exposure	Reference level for occupational exposure
Limits	Not defined	400 mT	2 T for head and trunk 8 T for limbs
Calculated value	<p>DC cables inside the substation: 6.2.2 Vertical: 204 μT in a distance of 1 m Horizontal: 200 μT in a distance of 1 m</p> <p>DC cables outside the substation and landfall area: 6.2.3 Vertical: 300 μT up to 2 m above the cables Horizontal: 300 μT 3 m from the cables In fault condition, the values are slightly higher.</p>		
Does the calculated value exceed the limit?	N/A	No	No
Remarks / recommendations	<p>Since the calculated values even in close distance to sources are much lower than reference levels for exposure of general public and workers, the exposure time and duration will be irrelevant however it is recommended as an ALARP measure to evaluate the installation of signs at the area the cables exit the fenced area to enter the sea e.g., "Keep distance, static magnetic field", otherwise the area should be provided by fences. This is to protect people with implanted electronic devices or implants containing ferromagnetic material, where the restriction level is 0.5 mT.</p>		

Table 7.2 - AC cables to transformers

	Investigation level	Reference level for general public exposure for 60 HZ	Reference level for occupational exposure for 60 HZ
Limits	0.4 μ T	83.3 μ T(200 μ T byNRPA)	416.6 μ T
Calculated value	<p>Vertical: It is assumed that the cables hang from the masts at an elevation about 7 m. Perimeter for magnetic field stronger than 83,3 μT is about 5m from ground level and thus no exposure to this level is foreseen.</p> <p>Flux intensity of 416.6 μT is not generated.</p> <p>Horizontal: to get below 0.4 μT, the person needs to be at least 35 m away from the furthest out 3 phase cable. Both cables together generate magnetic field stronger than 0.4 μT with an extension of 65 m from midpoint between cables to both train. Since the area within the fences is only 95 m wide, then the investigation level outside the fences will be exceeded.</p>		
Does the calculated value exceed the limit?	Yes	No	No
Remarks / recommendations	<p>To prevent general public from any exposure to 0.4 μT, investigation level, the facility should be widened to 130 m. However, assuming that the area outside of the fence is quite a remote place and visit by general public will take place in rare occasion, then widening of facility from 95 m to 130 m is deemed to be unnecessary. Because of low level of flux intensity and short term exposure of any bystander, the risk for ELF EMF outside the</p>		

	fences is assessed to be extremely low, however as an ALARP measure it is recommended to evaluate the installation of signs at the periphery of the facility to warn public to stay away from the facility.
--	---

Table 7.3 - transformers bushings

	Investigation level	Reference level for general public exposure for 60 HZ	Reference level for occupational exposure for 60 HZ
Limits	0.4 μ T	83.3 μ T(200 μ T by NRPA)	416.6 μ T
Calculated value	<p>Flux intensity of 416.6 μT is not generated.</p> <p>Horizontal: to get below 0.4 μT, the person needs to be at least 45 m away from the transformers. Both transformers together generate magnetic field stronger than 0.4 μT with an extension of 70 m from midpoint between transformers. Since the area within the fences is only 95 m wide, then the investigation level will be exceeded by a distance of 22.5 m from the fences.</p> <p>The reference level for public exposure can be reached in a distance of about 3.5 m from the source but since this area is inside the fences then such risk does not exist.</p>		
Does the calculated value exceed the limit?	Yes	No	No
Remarks / recommendations	As stated in table 7.2.		

Table 7.4 - AC cables from transformers to converters

	Investigation level	Reference level for general public exposure for 60 HZ	Reference level for occupational exposure for 60 HZ
Limits	0.4 μ T	83.3 μ T(200 μ T by NRPA)	416.6 μ T
Calculated value	<p>Vertical: The reference level for public exposure can be reached in a distance of about 1m above the cables but since this area is inside the fences then such risk does not exist.</p> <p>Flux intensity of 416.6 μT are not generated</p> <p>Horizontal: to get below 0.4 μT, the person needs to be at least 15 m away from the furthest out 3 phase cable. Both cables together generate magnetic field stronger than 0.4 μT with an extension of 35 m from midpoint between cables to both train. Since the area within the fences is 95 m wide, then long term exposure is not likely.</p>		
Does the calculated value exceed the limit?	Yes	No	No
Remarks/ recommendations	None		

Inside onshore converter substation, HVDC equipment such as reactors can generate magnetic field. It is recommended that rest room planned on second level adjacent to HV converter area is relocated to provide maximum distance.

7.3 Utsira High Power Hub platform

7.3.1 Description of area:

Utsira HPH platform is a Normally Not Manned (NNM) installation. According to ref. /11/, NNM UHPH platform has 3 main and 6 mezzanine deck levels. The HVDC train 101 is located on the Main deck areas E120 and E130 (EL.500.000) and on the mezzanine deck areas E220 (EL.505.000) and E330 (EL.508.000).

The HV transformers related to HVDC are also located on the main deck at east side. AC and DC cable J-Tube and cable hang-offs are located on the Main Deck area Q130 at the south side of platform.. AC sub-sea cables will be routed as single core cables in trefoil groups to the HV GIS Switchgear. Gas Insulated Switchgear (GIS) is located on Centre deck. /11/

Bridge landing area is located at north-west corner of this area.

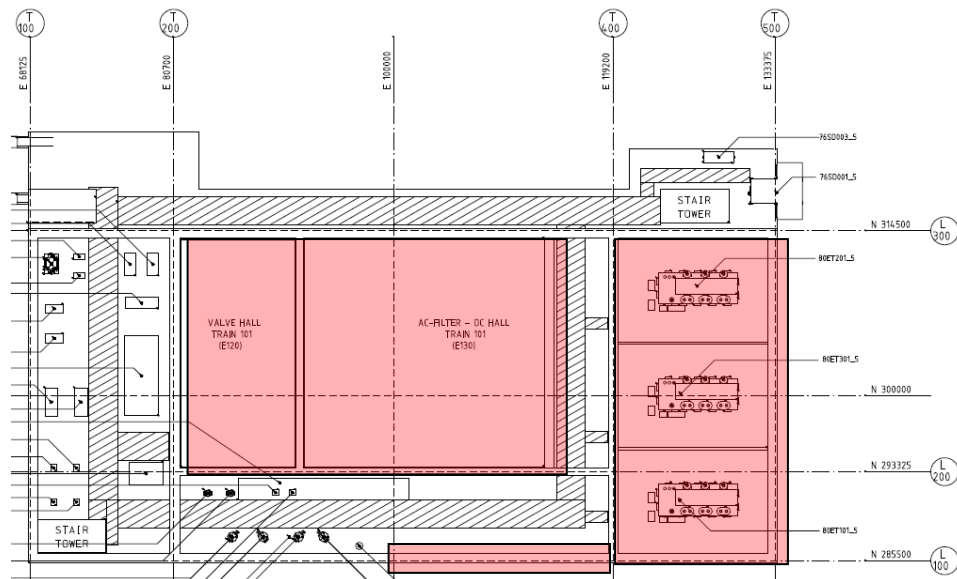

Figure 7.6 - Elevation: 500000, main deck (ref. /31/)

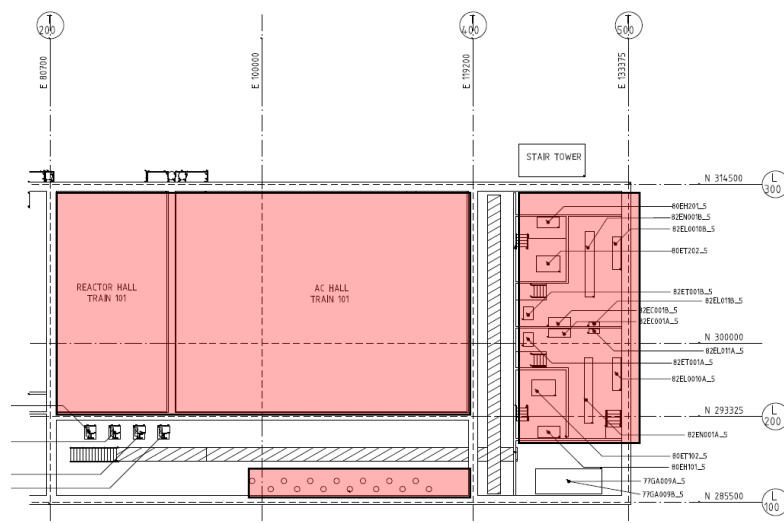

Figure 7.7 - Elevation 508000, Lower AC-Hall deck (ref. /32/)

The HVDC train 201 is located on the Centre deck areas E520 and E530 (EL.517.400) and on the mezzanine deck areas E620 (EL.522.400) and E730 (EL.525.400). HV Gas Insulated Switchgear (GIS) system is located on this deck too.

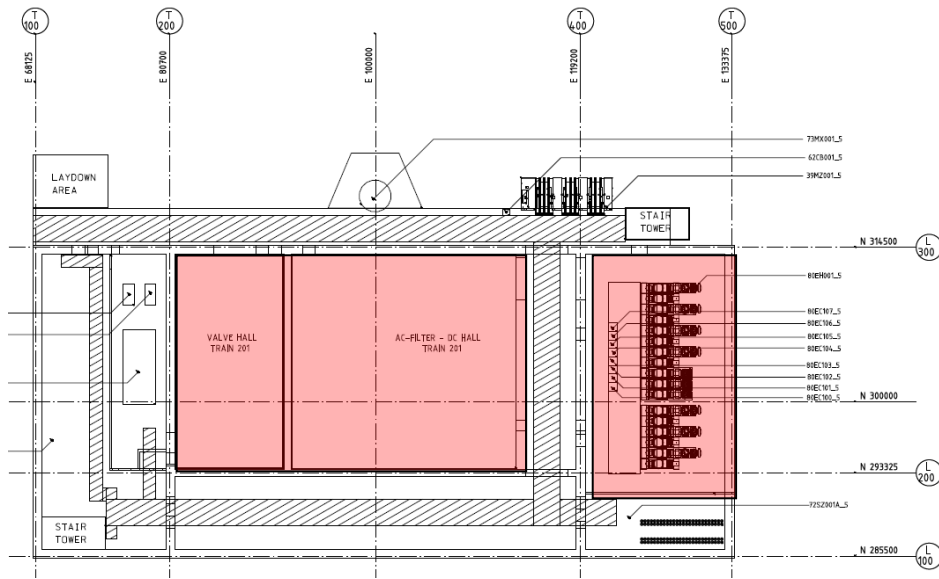

Figure 7.8 - Elevation: 517400, Centre deck (ref. /33/)

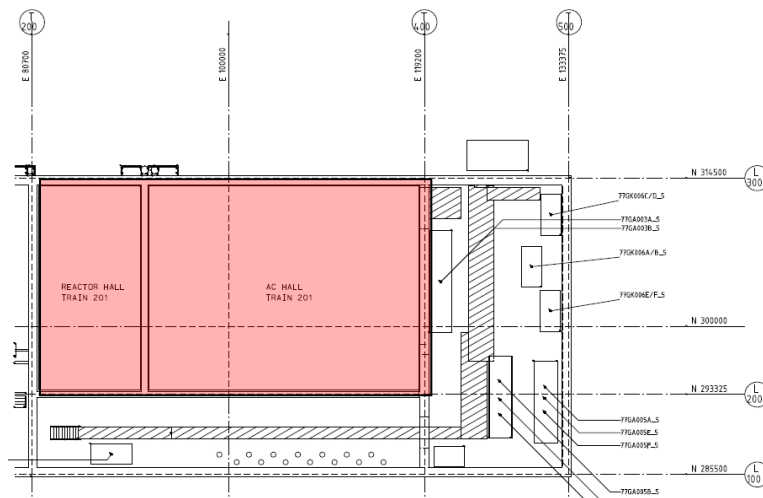

Figure 7.9 - Elevation: 525300, Upper AC hall deck

Pedestal crane is located at the north side of the platform

7.3.2 Planned safety barriers

It is assumed that offshore HVDC DC/AC conversion trains are protected by the same safety barriers as described for the onshore conversion train.

7.3.3 Operation, inspection and maintenance

As stated for onshore substation in previous chapter.

In addition, rotation offshore of offshore personnel on a basis of 2 weeks onboard and 3 or 4 weeks home will reduce the exposure time to any possible ELF EMF sources.

Regarding crane operation, lifting operation by pedestal crane is performed every second weeks. Duration of work is assumed to be 2 hrs. Standby boat approach is from the north side of platform.

7.3.4 Exposure time

As stated for onshore substation in previous chapter but with a reduction with respect to offshore rotation arrangement.

Operational staff:

$$((2 \text{ hrs} \times 52 \text{ weeks}) + (2 \text{ hrs} \times 12 \text{ months}) + (8 \text{ hrs} \times 5 \text{ days} \times 2)) \times (2/5) = 83 \text{ hrs / yr}$$

Vendor's staff:

$$(8 \text{ hrs} \times 5 \text{ days} \times 2) = 80 \text{ hrs / yr}$$

For crane operator:

$$2 \text{ hrs} \times 52/2 = 52 \text{ hrs / yr}$$

Assuming that long term exposure means that one person should be exposed at least 1/3 of his daily time in average during a year, i.e., 2920 hrs/yr., then the time durations estimated above could be considered as marginal.

7.3.5 Estimated magnetic flux intensity and exposure

Table 7.5 - DC cables, riser, hang-off area, DC cable route to converters

	Investigation level	Reference level for general public exposure	Reference level for occupational exposure
Limits	Not defined	400 mT	2 T for head and trunk 8 T for limbs
Calculated value	Vertical: 200 μT in a distance of 0.5 m Horizontal: 220 μT in a distance of 0.5 m In fault condition, the values are slightly higher.		
Does the calculated value exceed the limit?	N/A	No	No
Remarks / recommendations	Since the calculated values even in close distance to sources are much lower than reference levels for exposure of general public and workers, the exposure time and duration will be irrelevant.		

Table 7.6 - AC cables from DC/AC converter to AC transformers

	Investigation level	Reference level for general public exposure for 60 HZ	Reference level for occupational exposure for 60 HZ
Limits	0.4 μT	83.3 μT(200 μT by NRPA)	416.6 μT
Calculated value	Flux intensity of 416.6 μT is not generated. To get below 0.4 μT, the person needs to be at least 6 m away from the furthest out 3 phase cable. Both cables together generate magnetic field stronger than 0.4 μT with an extension of 16 m from midpoint of cables between both trains. To be exposed for 83.3 μT, person should be in a distance less than 1 m from cables. This level is for general public exposure and not relevant for the offshore platform.		
Does the calculated value exceed the limit?	Yes	No	No
Remarks / recommendations	As stated in table 7.5		

Table 7.7 - transformers bushings

	Investigation level	Reference level for general public exposure for 60 HZ	Reference level for occupational exposure for 60 HZ
Limits	0.4 μ T	83.3 μ T(200 μ T by NRPA)	416.6 μ T
Calculated value	<p>Flux intensity of 416.6 μT could be possible in a distance of about 3 m from bushings.</p> <p>To get below 0.4 μT, the person needs to be at least 60 m away from the transformers. Both transformers together generate magnetic field stronger than 0.4 μT with an extension of 120 m from midpoint between transformers. This means that all areas on the platform will see that level of flux density.</p> <p>The reference level for public exposure can be reached in a distance of about 7 m from the source but since this area is part of offshore facility then such risk does not exist.</p>		
Does the calculated value exceed the limit?	Yes	No	Yes
Remarks / recommendations	<p>Stair tower and escape chute area at north side can be exposed for moderate magnetic field at public exposure level, however since the occupational exposure level is much higher and platform is a NNM installation, no further measures assumed to be required.</p> <p>Risk reduction measure: Entrance to transformer room shall follow the work permit system with strict time limitation for entrance to the room when the transformer is in operation. Since the reference level for occupational exposure exceed at places 3 m from the bushings, if necessary at all, any inspection to the room requiring approach to the equipment shall not exceed more than few minutes.</p> <p>In addition, a sign board at the entrance door to the transformer room warning about the hazard is recommended. For instance, "No entrance, Non-ionizing magnetic field)</p> <p>ALARP measure: evaluate the installation of warning signs at the area close to the HV transformer rooms. For example "keep distance, HV area".</p>		

Table 7.8 - HV AC cable GIS termination UHPH

	Investigation level	Reference level for general public exposure for 60 HZ	Reference level for occupational exposure for 60 HZ
Limits	0.4 μ T	83.3 μ T(200 μ T by NRPA)	416.6 μ T
Calculated value	<p>Flux intensity of 13 μT could be possible in a distance of about 3 m from the termination points.</p> <p>To get below 0.4 μT, the person needs to be at least 20 m away from the termination points.</p> <p>Flux intensity of 416.6 μT or 83.3 μT is not generated.</p>		
Does the calculated value exceed the	Yes	No	Yes

limit?			
Remarks / recommendations	<p>Areas adjacent to the GIS room can be exposed for low magnetic field, above 0.4 μT. However, since UHPU is a NNM platform then prolonged exposure is not possible. As an ALARP measure, evaluate the installation of warning signs at the area close to the HV transformer rooms. For example "keep distance, HV area".</p>		

7.4 Bridge between Utsira HPH and Johan Sverdrup

7.4.1 Description of area

The Utsira HPH platform will be installed close to the Johan Sverdrup platform and platforms will be linked with a bridge connection of about 120 meters long. The AC cables from the 33 kV GIS assembly at the Utsira hub are expected to be routed to a cable bridge outside of the hub and follow this to the connecting bridge. The cables will be routed either above or below area accessible to people/transport.

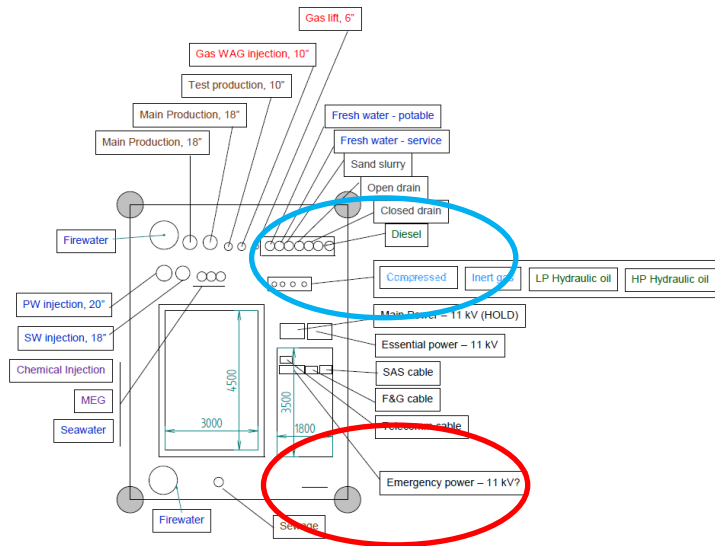

Figure 7.10 - Preliminary cross section drawing of bridge to Johan LQ platform /34/

7.4.2 Planned safety barriers

Traffic on the bridge is assumed to be restricted only for staff required to visit Utsira HPH platform.

7.4.3 Operation, inspection and maintenance

- It is assumed there are no equipments on the bridge requiring maintenance.
- The inspections are performed by two persons, based on a weekly routine.
- It is assumed that travel from one end of bridge to other end of the bridge takes no longer than 2 minutes.
- It is also assumed a monthly demand to visit the station due to alarms or other requests.
- Maintenance is down four times a year (two times a year for each train)
- Each maintenance lasts for 5 days
- Vendor's staff can be present in LER rooms for longer period for collection of data and monitoring during their campaigns. It is assumed that they visit the facility twice each year with duration of 5 days each week. Their working shift lasts for 8 hours.
- Start up phase/commissioning is not part of this study/scope
- In addition, rotation offshore of offshore personnel on a basis of 2 weeks onboard and 3 or 4 weeks home will reduce the exposure time to any possible ELF EMF sources.

7.4.4 Exposure time

Operational staff:

$$2 \times 2 \times (52 + 12 + (4 \times 5)) \times (2/5) = 67 \text{ min pr. year}$$

Vendor's staff:

$$2 \times 2 (2 \times 5) = 40 \text{ min pr. year}$$

Assuming that long term exposure means that one person should be exposed at least 1/3 of his daily time in average during a year, i.e., 2920 hrs/yr., then the time durations estimated above could be considered as marginal.

7.4.5 Estimated magnetic flux intensity and exposure

Table 7.9 - AC cables on bridge

	Investigation level	Reference level for general public exposure for 60 HZ	Reference level for occupational exposure for 60 HZ
Limits	0.4 μ T	83.3 μ T (200 μ T by NRPA)	416.6 μ T
Calculated value	Vertical: The investigation level is reached in a distance of about 8m above or below the cables. Thus this will affect the whole walkway on the bridge. Maximum level of 15 μ T can be expected in about 1 m distance from the cables. 3 μ T can be expected in the walkway. Flux intensity of 416.6 μ T is not generated.		
Does the calculated value exceed the limit?	Yes	No	No
Remarks / recommendations	It is recommended as an ALARP measure to locate the cables underside the bridge instead of routing on the top to reduce the exposure of head and upper body parts. It is also recommended to locate the cables at the side allocated for the lift truck traffic, away from the personnel walkway.		

7.5 Johan Sverdrup connection point

7.5.1 Description of area

Johan Sverdrup LQ platform is designed for 550 persons. High voltage electrical room is located at east-south corner of LQ platform on cellar deck. High voltage switchgear is located on the lower mezzanine deck, approximately in the mid section. Telecom & Instrument room is located on the lower mezzanine deck adjacent to the HV SWG room. Operational Offices are located on utility mezzanine deck above lower mezzanine deck. Project offices are located wall-to-wall with high voltage switchgear room and operation offices are located one deck above (utility). Cables are routed from transformers to switchgear at the periphery of the platform (i.e., not crossing the walls to other rooms). 11 kV cable from LQ is not included in the scope of this study.

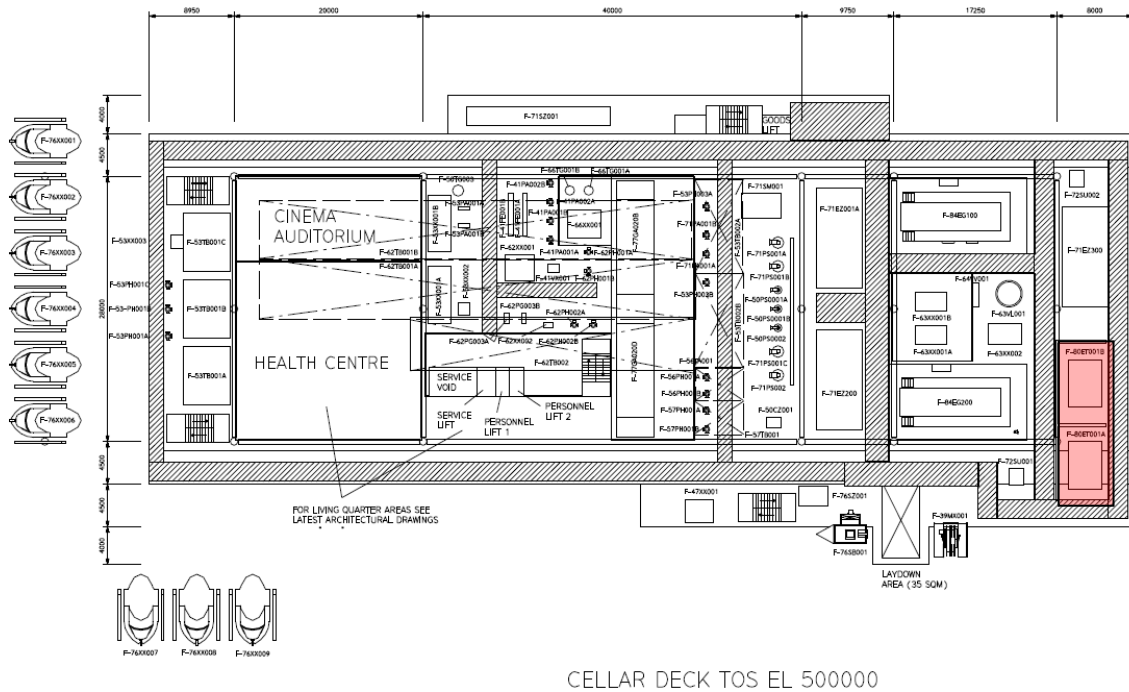

Figure 7.11 - Johan Sverdrup LQ, Cellar deck, ref. /39/

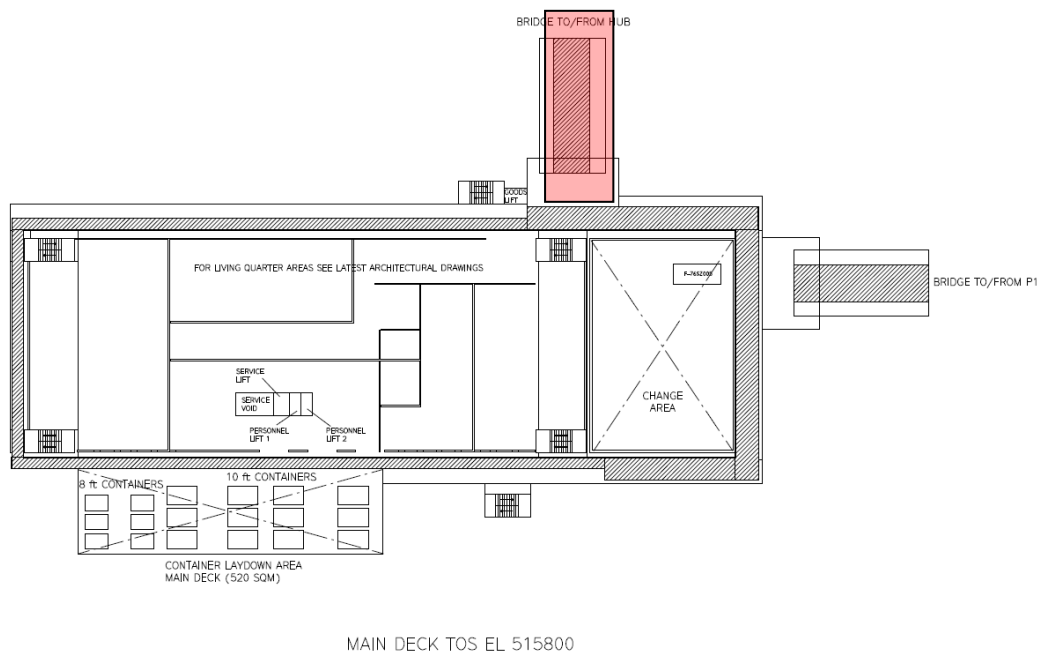

Figure 7.12 - Johan Sverdrup LQ, Main deck, ref. /40/

7.5.2 Planned safety barriers

- Access to HV area only by authorized personnel.
- HV rooms are locked.

7.5.3 Operation, inspection and maintenance

- As for HV rooms described for Utsira HPH

7.5.4 Exposure time

- This is a LQ platform and exposure of personnel is deemed to be higher than Utsira HPH.

7.5.5 Estimated magnetic flux intensity and exposure

Table 7.10 - HV AC cables on Johan Sverdrup platforms

	Investigation level	Reference level for general public exposure for 60 HZ	Reference level for occupational exposure for 60 HZ
Limits	0.4 μ T	83.3 μ T(200 μ T by NRPA)	416.6 μ T
Calculated value	Vertical: The investigation level is reached in a distance of about 4m above or below the cables. Thus this might affect the whole walkways on the decks. A maximum level of 5 μ T can be expected from the cables. Flux intensity of 416.6 μ T or 83.3 μ T are not generated		
Does the calculated value exceed the limit?	Yes	No	No
Remarks / recommendations	It is recommended, as an ALARP measure to locate the cables underside the decks instead of routing on the top to reduce the exposure of head and upper body parts or in case not possible provide the maximum distance from the escape / access routes.		

Table 7.11 - HV AC cable GIS termination Johan Sverdrup

	Investigation level	Reference level for general public exposure for 60 HZ	Reference level for occupational exposure for 60 HZ
Limits	0.4 μ T	83.3 μ T(200 μ T by NRPA)	416.6 μ T
Calculated value	Flux intensity of 40 μ T could be possible in a distance of about 1 m from the termination points. To get below 0.4 μ T, the person needs to be at least 8 m away from the termination points. Flux intensity of 416.6 μ T or 83.3 μ T is not generated.		
Does the calculated value exceed the limit?	Yes	No	Yes
Remarks / recommendations	Utility rooms / corridors adjacent the GIS room can be exposed for low magnetic field, above 0.4 μ T. However, since none of these areas are considered to have a status as a workshop or office, then no measure is deemed to be required. As an ALARP measure, evaluate the installation of warning signs at the area close to the GIS room. For example "keep distance, HV area".		

8. ASSESSMENT OF MARINE ENVIRONMENT EXPOSURE RISK

The subsea power cables from Haugsneset to Utsira High have the potential to disturb the natural magnetic field in surrounding waters. Some marine organisms have the ability to sense magnetic and/or electric fields and often utilise them for several essential life functions, e.g. feeding, migration, navigation etc. As such, any disruption to the natural sources of electromagnetic fields (EMF) could possibly affect the marine fauna. Hence, the possibility for interference with biological processes must be assessed.

This chapter includes an overview of the areas relevant for anthropogenic magnetic field exposure to the marine environment, the marine environment in the project area as well as assessments of the interactions and potential effects from these fields.

8.1 The marine environment in the project area

In order to assess the potential impacts on marine organisms in the vicinity of the planned DC cables, it is essential to determine the relevant marine species in the area. This section provides a brief description of the surrounding marine environment, focusing on species possible sensitive to disturbance of the natural magnetic field .. This section is primarily based on the report "Utsira High electrification – Environmental and social impacts", which comprise the two planned DC cables from Haugsneset to Utsira High /5/. Please refer to reference /5/ for details. The possible impact on the surrounding is described in section 8.3.

The Norwegian part of the North Sea consists of a diverse benthic fauna, typically with benthic invertebrates living on or buried beneath the seabed. In Boknafjorden, where the cables are routed through, the benthic composition will vary with depth and sediment conditions. In areas where the water depth exceeds 500 m the benthic fauna have been found to consist of 45 species, e.g. crustacean /5/. Few studies have been performed on electromagnetic sense on invertebrates. Still, recent evidence points to electromagnetic senses in decapod crustaceans (e.g. crabs, shrimps and lobsters) /13/.

Shallow waters also have a rich benthic fauna, where several of the species are buried in the sediments, e.g. sea urchins which have shown some physiological changes when exposed to EMF /5/, /13/. Coral reefs are mostly found in the northern part of the North Sea and no registrations have been made of coral reefs within the project area /5/.

Several fish species can be found in the North Sea. E.g. species such as cod, haddock, hake, ling, angler, blue whiting and grayfish are characterized as bottom fishes, while herring, mackerel, Norway Pout and blue whiting belong to the pelagic group. Pollock which can be characterized as both a pelagic and bottom fish is also typically found in the North Sea. With respect to abundance and economic value, pollock, herring, Norway pout, mackerel, horse mackerel, cod, ling and hake are assessed as the most important fish species /5/. It is however uncertain if these non-elasmobranchs are sensitive to magnetic or/and electric fields /5/.

Minke whale, porpoise and some type of dolphins occur regularly in the Norwegian part of the North Sea, whereas porpoise is considered as the predominant. In addition, harbour seal and grey seal will also be present in the area /5/. The current literature only provides a theoretical effect to these marine mammals with respect to EMF /13/.

The cable will cross two areas that are considered to be particularly vulnerable, referred to as the Karmøyfeltet and Boknafjorden. Karmøyfeltet is characterised as a spawning ground for Norwegian herring, while Boknafjorden is considered a moulting ground for seals. No red-listed species have been registered along the planned DC cables since 2000 /5/.

8.2 Identified areas relevant for exposure to EMFs

As previous pointed out, DC cables are considered to cause a larger degree of possible impacts compared to AC cables. In order to assess the potential effects from the High Voltage Direct Current (HVDC) subsea cables it is essential to identify and describe the areas which are relevant for exposure to EMFs. With regards to the marine environment the routing of the two HVDC cables are of outmost concern and are therefore described in the following.

8.2.1 DC sea cable to the hub (Utsira)

The planned DC cables will start at the converter station at Haugsneset and end at the Utsira High Power Hub (UHPH) in the Norwegian part of the North (see fig. 1.2). In addition to the Earth's geomagnetic field, the DC cables will contribute as a new source of static magnetic field. It is assumed that the cables will be shielded, which in practice mean that the cables will not be a direct source to the electrical field. However, the potential for an induced electrical field (iE-field) is still present.

The iE-field is described by e.g. Faraday's law of induction and Lenz's law, the latter stating that "an induced electromotive force always gives rise to a current whose magnetic field opposes the original change in magnetic flux". Relating this statement to the HVDC cables and consequence for the marine organisms, the HVDC cables will set up a static magnetic field which for an organism that moves within the perimeter of the cables will be experienced as a changing magnetic field dependent upon the velocity and direction of movement.

This movement (change in magnetic flux) will result in an induced current in the organism (setting up a counteracting magnetic-field) opposing the change. This current may also be described by an induced electric field and the current carrying properties of the organism. The latter not being well known, the induced electric field is commonly used as measurement level concerning the influence of magnetic field. The strength of the induced current (subs. Electric field) is dependent upon the rate which the magnetic field changes when an organism moves, and is therefore related to the velocity and direction of movement, the worst case being high speed movement perpendicular to the cables at close distance.

Several aspects regarding a subsea cable system must be evaluated during the planning phase. Factors such as type and configuration of cable systems will highly affect the characteristics of EMFs. For instance, design and installation factors such as distance between cables, cable orientation relative to the geomagnetic field (DC cables only), burial depth (as it indicate the distance between the cable and an organism) and current flow will affect EMF levels in the vicinity of a cable /13/.

Both the DC cables will exit at the onshore converter station located at Haugsneset and enter the seabed through a landfall area. The conditions set for the EMF calculations include a cable separation and distance cable-neutral of 3 m. Furthermore, the cable burial depth has been set at 0.6 m.

From a certain distance from land the DC cables, respectively DC1 and DC2, will follow different individual mapped routes to the Utsira hub station. The cable separation at the seabed will vary between 3 m and 4,000 m and there will be seabed electrodes instead of cable-neutral. Due to uncertainties regarding the cable burial depth, a worst case scenario of 0.1 m has been implemented in the calculations. If possible, the sea cables will be laid in a seabed trench. An alternative is to cover the sea cables by stones or other protection.

Typically, the cable sheaths, armouring and burial will block the electric field of the conductors from reaching the environment. Hence, the magnetic field and induced electric fields are the most relevant components which are to be taken into consideration when planning subsea cable systems. Lower voltage cable systems, e.g. cable systems carrying power from individual wind turbines, are either laid on top of the seabed or buried approximately one meter below the sea bottom. High voltage cable systems are normally buried underneath the seabed in order to minimise the possibility of physical damages on the cables. However, there may be certain sections of the higher-voltage cable systems that are not completely buried, e.g. edges, cable crossing over

rocks or with already existing pipelines etc.

In order to gain an overall picture of the possible effects from the Utsira power cable, the areas containing sections with cable crossings must be identified and assessed. According to the current Statoil drawings of the planned HVDC cables there will be 13 and 14 crossings with existing pipelines/cables for the DC1 and DC2 cable, respectively /17/, /18/. These crossings are presented in Table 8.1, which also shows the assumed crossing points relative to the onshore conversion station /18/.

Table 8.1 - Crossings associated with DC1 cable and DC2 cable

Number	Item	Status	Assumed burial status	Crossing point DC1 cable (m)	Crossing point DC2 cable (m)
1	Cable (TBC)	-	-	NA	302
2	ROGASS gas pipeline	Operating	Exposed	601	16 141
3	Cable (TBC)	-	-	20 171	23 451
4	Telecom Cable (Kvitsøy-Karmøy 1)	Operating	Exposed	27 769	28 955
5	Telecom Cable (Kvitsøy-Karmøy 2)	Out of use	Exposed	27 893	29 131
6	Telecom Cable (Kvitsøy-Karmøy 3)	Operating	Exposed	27 897	29 179
7	EUROPIPE II gas pipeline	Operating	Exposed	30 567	34 200
8	DC3 cable	Future	NA	36 034	35 348
9	TAMPNET fibre optic cable	Operating	Exposed	69 185	80 244
10	SLEIPNER condensate pipeline	Operating	Exposed	69 253	80 296
11	Statpipe S34 gas pipeline	Operating	Exposed	69 446	80 509
12	DANICE	Operating	Exposed	100 034	100 823
13	CANTAT 3 telecom cable	Operating	Exposed	105 870	106 886
14	ZEEPIPE 2B	Operating	Exposed	159 450	164 710

*NA: Not applicable

From Table 8.1 it is possible to see that the majority of the existing pipelines are assumed exposed. As indicated in the drawings, these crossings will typically be subject to pre-lay rock installation, a post-lay cover and finally supplemented with counterfill. The pre-lay rock will be installed in accordance with Statoil specification TR 1370, "Subsea rock installation". The post-lay cover will be extended to the touch down points of the different crossing cables, while the counterfill will stretch additional 10 meters in width. The geometry and length of the transition zones at the crossings will affect the required length of the post-lay covers. These have however not been defined at this stage of the project. The height of the post-lay cover will be expressed relative to the touch down points of the crossing cable. Unless otherwise is specified the minimum slide slope ratio of the post-lay cover and counterfill will equal 1:2:5, giving approximately 2 and 3 meters of counterfill at the sides. This should indicate that the crossings are completely covered.

8.3 Assessment of EMF impacts from DC cables to the marine environment

The subsea power cables constitute possible environmental concern due to the potential effects of EMFs. With regards to the Utsira HVDC cables, this is only related to the organisms that are sensitive towards magnetic- and iE-fields, as the species that does not possess these properties are not believed to be affected. The current understanding with respect to potential impacts to marine species from anthropogenic EMFs, such as subsea power cables, is rather limited /13/. It is evident that knowledge gaps exist in certain areas affiliated with this matter and that the need for more direct evidence is required.

Previous studies have shown that measured and calculated EMF from subsea power cables lie within the expected range of detection of marine species receptive of EMF. Still, even though some species may be able to detect these fields, the current research results do not indicate a definitive negative impact /19/. In addition there are a number of conditions that has the potential to influence an observed EMF effect. For instance, EMF effects may depend on the source, location, and characteristics of the anthropogenic source, as well as the presence, distribution, and behaviour of aquatic species relative to this source /16/. Currently it is a large number of uncertainties regarding how EMF might impact marine species. Hence a more general description is given in this section.

8.3.1 Potential effects

The majority of the research on environmental effects from EMF has been related to AC power cables. However, it is currently assessed that there does not exist enough information to evaluate the specific differences between AC and DC transmission with respect to environmental effects from EMF /19/. Hence, the following section presents results from studies affiliated with AC power cables, which are used when assessing the calculated values for the magnetic fields from Utsira HVDC cables.

As described previously, various species use the Earth's magnetic field to provide orientation during migrations. The natural magnetic field could be subject to local differences as a consequence of e.g. HVDC subsea cables. Depending on how the cables are situated in relevance to the magnetic north-south, the static magnetic field could either intensify or reduce the resulting magnetic field. The DC cables from Haugsneset to Utsira High will mainly be situated east-west of the magnetic north-south, which will give a somewhat smaller deviation. In the area near Haugsneset, the cables are routed north-south, giving a larger deviation from the Earth's magnetic field. Receptor species that can detect EMF will normally either avoid or be attracted to the EMF. If an effect has been identified then it is essential to determine whether the effect is avoidance or attraction to the EMF in order to predict the specific impacts for the individual animal /14/.

Several suggestions have been made towards the possibility that migratory species may be negatively affected if their navigation is impaired by the EMF. For instance, it is proposed that these species may be slowed or deviated from their intended routes, consequently hindering them in reaching essential feeding, spawning or nursery grounds. Furthermore, it is suggested that species that utilises EMF to seek food or detect predators could unnecessarily alter their behaviour, or this ability could be undermined by anthropogenic EMF sources. If these behavioural deviations are adapted by enough individuals, the idea is that the population and communities that these species belong to may be adversely affected /13/. Thus, depending on the magnitude and persistence of the altered magnetic field it could either give a trivial temporary change in swimming direction or a more serious delay to migration. However, currently it has not been determined whether anthropogenic induced electric fields will cause attraction or repulsion for fish and other receptor species /14/.

A recent study, "Impact of Electric and Magnetic Fields from Submarine Cables on Marine Organisms", has been modelling the magnetic field from five different buried AC power cables and induced electric fields /19/. It is pointed out that the DC cables of Utsira have the potential to cause a larger degree of possible environmental impacts compared to AC cables, as previously described. The modelling showed that the maximum strength of the magnetic field produced by the cable ranged from 2 – 35 μT , depending on the cable setup and current load.

In addition, the study included a literature review regarding impacts from EMF on marine organisms. Comparison of the thresholds identified in the literature study with the modelling results, indicated that species receptive to EMF may come across detectable EMF emitted by a power transmission cable in a range of up to a few hundred meters. The relevant distance will depend on the species and the cable characteristics/19/.

The same study also showed that the field strength decreased rapidly with the distance from the cable. For instance, a maximum of 35 μT immediately above the cable was estimated to be reduced to 2.2 μT at a distance of 2 meters from the cable. This was also the conclusion during a study on effects from EMFs from undersea power cables on elasmobranchs and other marine species /13/. The modelling of magnetic fields along the seabed perpendicular to AC undersea cables from different wind energy projects indicated that the intensity of magnetic and induced electric fields would be experienced as a gradient relative to distance from the cable. In other words, when a fish approaches the cable the intensity of the field would increase and diminish when it moves away from the cables. This could either be vertically or horizontally /13/. From this, it would be reasonable to anticipate that fields emitted by a submerged or buried subsea cable would influence benthic species and those present at depths to a higher degree than those occupying the upper portion of the water column. However, it must be emphasised that this assumption has not yet been validated in an in-situ environment with EMF measurements /15/.

Benthic species have been known to use electroreception for locating food, while induced electric fields would only be relevant for pelagic (open water) species during specific periods such as reproductive season. From this, it is assumed that the potential for an impact from EMFs is largest for species that depend on electric cues to detect benthic prey and mates, as well as early life stages that use electroreception to detect predators or migratory routes which take them into shallow coastal waters /14/.

It has been indicated that AC power cables (assumed to be buried 0.5 meter within the sea bottom) have the potential to produce magnetic field varying between 2 to 35 μT , immediately above and 2 metres from the cables respectively. According to the available literature this range is within the detection thresholds species sensitive to EMF. The minimum sensitivity values, with respect to magnetic fields, have found to be 10, 25 and 32 μT , varying between different species, please refer to chapter 5.4. Based on the relative low sensitivity levels of magnetosensitive species, it is assumed that these species are most vulnerable with respect to potential impacts possible caused by the power cables. It is underlined that the DC cables are in general considered to cause a larger degree of possible impacts compared to AC cables. The majority of the subsea power cables from Haugsneset to Utsira High is planned to be buried below the seabed and shielded, minimising any possible impacts. The shielding will however not affect the magnetic field and hence have little effect on an iE-field /5/.

8.3.2 Evaluation of EMF results

The EMF calculations presented in chapter 6 gives a good indication of the DC magnetic field development affiliated with the two DC cables. Regarding the marine environment, it has previously been stated that the marine organisms most likely to be affected by the magnetic field are those in the near vicinity of the power cables.

As pointed out in chapter 8.2.1, the magnetic field calculations were based on a burial depth of 0.6 m near Haugsneset while the subsea cables further out from shore were set with a worst case scenario of 0.1 m. Due to burial or rock dumping, it is normally not possible to get closer than approximately 0.5-1 m in a distance from the sea cables. Hence, the vertical distance of 1 meter from the DC cables was chosen as most relevant for this evaluation and implemented in the magnetic field calculations for the marine environment. It is also emphasised that the Earth's geomagnetic field has not been accounted for in the EMF calculations.

From Figure 6.6 it is seen that the strength of DC magnetic field is to some extent different when the DC cables operate during fault mode and operational mode. The distance between the cables in this situation is approximately 3 m. During operational mode, with two functioning cables, the peaks will be approximately 180 μT . In the low point between the cables, the magnetic field is about 175 μT during operational mode. However, during fault mode, with only one functioning cable, the peak will be 220 μT .

However, the strength of the magnetic field will decrease rapidly with increasing horizontal distances from the cables. At roughly 2 and 4 meters away from the cables, the EMF strength during operational mode has decreased to 70 and 30 μT , respectively. As the Earth's geomagnetic field typically will vary between these two values (normally at 50 μT), this indicates that the intensity of the induced magnetic field is reduced to the background level at a distance between 2 and 4 meters.

If there is a fault in the system, only one of the cables might be functioning. Such faults could potentially have long duration times (months) and create a more powerful magnetic field. This phenomenon is also illustrated in Figure 6.6, where the strength of the magnetic field decreases as a function of distance with a slower rate compared to two functioning cables. The magnetic field flux density has decreased to 70 and 30 μT at approximately 3 and 7 meters away from the cables, respectively.

As previously described, Figure 6.7 demonstrates that the intensity of the magnetic field will decrease as a function of the distance to the power cables. During normal operation the peaks from the distances 1.5, 2 and 4 meters above the cables will be 124, 89 and 31 μT , respectively. This indicates that at a vertical distance of 4 m above the cables the EMF is almost below the range of the Earth's natural geomagnetic field. This will depend on the geomagnetic field in the area in question, whereas in this case, for instance, equals 50 μT in Stavanger. The generated magnetic field from the DC cables will thus be well below the natural geomagnetic field in Stavanger at 4 meters above the cables.

It is pointed out that the maximum magnetic-field strength at a certain vertical distance, for the distances between the cables as relevant in this assessment, will be almost the same even though the distance between the cables changes. For instance, at a vertical depth of 1 meter the peaks are still at 180 μT during operation mode, even though the distance between the cables has increased to 20 meters, please refer to Figure 6.8. The same applies during fault mode, where the peak will stay at 220 μT with a vertical distance of 1 meter above the cable, illustrated in Figure 6.9. However, the low point between the peaks will decrease as the distances between the DC cables increases. In Figure 6.8 the lowest point between the cables is approximately 40 μT , which is 135 μT lower compared to distance of 3 m between the DC cables (please refer to Figure 6.6).

In addition, an increasing distance between the cables will consequently increase the horizontal distance required for the intensity of the magnetic field to fall back to the background level. For instance, in areas where the DC cables are separated with 1000 (Figure 6.11) and 4000 meters (Figure 6.12), the intensity of the magnetic field will be reduced to 30 μT at approximately 7 meters away from the cables. This can be seen in comparison with the situation where the cables are separated by 3 meters (Figure 6.6). The intensity of the magnetic field will then be reduced to 30 μT at approximately 4 meters distance from the cables.

From Figure 6.10 it is seen that the EMF results during operational and fault mode starts to overlap as the distance between the DC cables increases. This is due to the fact that the two cables will have a decreasing effect on each other during normal operation as the distance between them increases.

As pointed out in chapter 5.4.3, the minimum detection thresholds for magnetosensitive species are found to be 10, 25 and 32 μT , varying between different species. The appurtenant maximum detection limits will vary between 50, 100 and 168 μT , respectively. Assuming a burial depth of 1 meter for the planned DC cables, the results from the magnetic field calculations indicate that the magnetic field from the cables will lie above the expected detection range for these organisms. According to the magnetic field calculations the maximum strength of the magnetic field one meter above the cables will be 180 and 220 μT for operational- and fault mode, respectively. It must however be emphasised that a burial depth of 1 m is not a definitive burial depth for the planned DC cables. In addition, the cables will be subjected to post-lay rock and counterfill in areas of crossing etc.

Supporting previous modelling of magnetic fields along the seabed perpendicular to subsea cables, the results from the EMF calculations indicate that the intensity of induced EMF will be experienced as a gradient relative to the distance from the cable, both vertically and horizontally. From this, it is assumed that the benthic species would potentially be affected in a larger degree compared to the pelagic species. Such impacts from the magnetic field are limited to the area in vicinity of the DC cables.

The current research indicates some behavioural effects in certain experiments for species that utilises the magnetic field for navigational purposes (eel) and for detecting prey (elasmobranches). Still, these effects have either been evaluated as small or the results have not been suitable to use to determine potential negative or positive environmental impacts /19/. However,

in the case of a potential effect, this would depend on site specific and project specific factors related to both the magnitude of EMFs as well as the ecology of the specie in question. In addition, the research results regarding the detection range and thresholds of the species are relatively inconsistent. Even though the magnetic field calculations indicate that the magnetic field might exceed the magnetic thresholds in the near vicinity of the cables, the information necessary to understand the potential response and resulting consequences to marine individuals or populations are limited.

9. RISK REDUCTION MEASURES

9.1 General

The magnetic field from electrical equipment may in general be reduced effectively by the following measures

- Reduce current flow, e.g. by reducing consumption or increase voltage level
- Keep distance between conductors as low as possible, trefoil for sets of AC-cables
- Increase distance between conductors and sensitive areas
- Establish active or passive current loops between source of field and sensitive areas
- Ferromagnetic shielding (AC only)
- High conductivity screen (AC cables only)

All measures may have economical, practical or environmental consequences and/or issues depending on e.g. the type of installation, existing or planned installation and the surroundings.

9.2 Human exposure

Exposure risk to magnetic field can be also reduced by limiting the frequency and duration of visits to areas susceptible for higher magnetic field flux intensity.

Layout design of facilities shall follow all the criteria required by working environment best practices, including the aspects related to ELF magnetic field to provide an optimal solution for a healthy working environment.

9.3 Marine environment exposure

In spite of the scarce literature on the subject there are still some potential aspects to consider regarding to the marine environment. Changing the burial depth will not reduce the strength of the magnetic field, it will only increase the distance between the cable and the marine organism. Even though, the most prominent way of reducing the produced magnetic field is to choose a proper cabling technique. For instance, a technique where the magnetic fields from several conductors cancel each other out could be an option. This would consequently reduce the anthropogenic magnetic field strength. Moreover, other cable design parameters, such as conductivity and permittivity, could also affect the emitted /19/.

10. RECOMMEND SCOPE FOR FOLLOW UP EMF STUDY

In general, it is recommended that the project follows up the result of this study during the next steps when more detail data is provided. This study as any other coarse risk assessment is based on some preliminary data and assumptions and these require to be validated further during the project development.

- For major equipments used in HV circuits such as HV transformers and switch gears, vendors of equipments have to be consulted by qualified personnel to collect reliable data about ELF EMF generated by such equipment. Bus bars within and between switchgears is one of the main sources for generation of ELF EMF.

Supplier of HVDC VSC has to be consulted with respect to generation of ELF EMF from their equipment such as reactors and IGBT valves inside the converter areas. Faraday's cage used in construction of building surrounding the HVDC VSC is only effective against radio interference (RI). The supplier has to provide data either by direct measurement from existing facility and extrapolation to predict the level of magnetic field or perform his own predictions by calculations.

- A follow-up study is recommended to be carried out when the supplier of HVDC VSC has been selected and updated data regarding equipment and cable routing offshore and on-shore are available. Such a follow-up study has to be carried out in a more extended time frame with possibility for more detail review of all possible sources from national and international sources.
- Considering the AC cables routed between UPHH and Johan Sverdrup, further calculations may be performed including the knowledge of e.g. bridge construction materials and design to determine the field distribution more accurately. If wanted, one may investigate other cable layouts, such as cables placed at e.g. two vertical layers to compress the higher level fields to low exposure areas.
- It is recommended that EMF studies are expanded to cover all HV power transmissions and distributions to platforms intended for Johan Sverdrup Field Centre. This includes also the bridge between the platforms.
- It is also recommended that field measurements are performed at facilities with similar characteristics and type of performance (e.g., Kollsnes/Troll A power transmission) to gain a better understanding of the scale of electric and magnetic fields.
- This study is based on infrequent inspections and remote monitoring of facilities assumption with respect to occupational exposure risk. It takes into account normal inspection and maintenance activities during a year, however it does not discuss the cases when one of the conversion trains is broken down requiring extensive maintenance / replacement which might lead to longer exposure time from the other train in operation. It is thus recommended that this case is evaluated further in consultation with the HVDC supplier to find ALARP measures to reduce any likely exposure.

APPENDIX 1 MAIN ISSUES FIELD CALCULATIONS

**APPENDIX 2
GEOGRAPHIC EXTENT OF AREAS/ZONES WITH HIGH COMPASS DEVIATION NEAR SHORE**

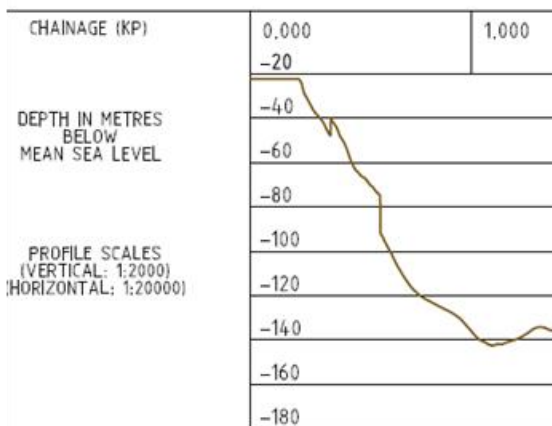
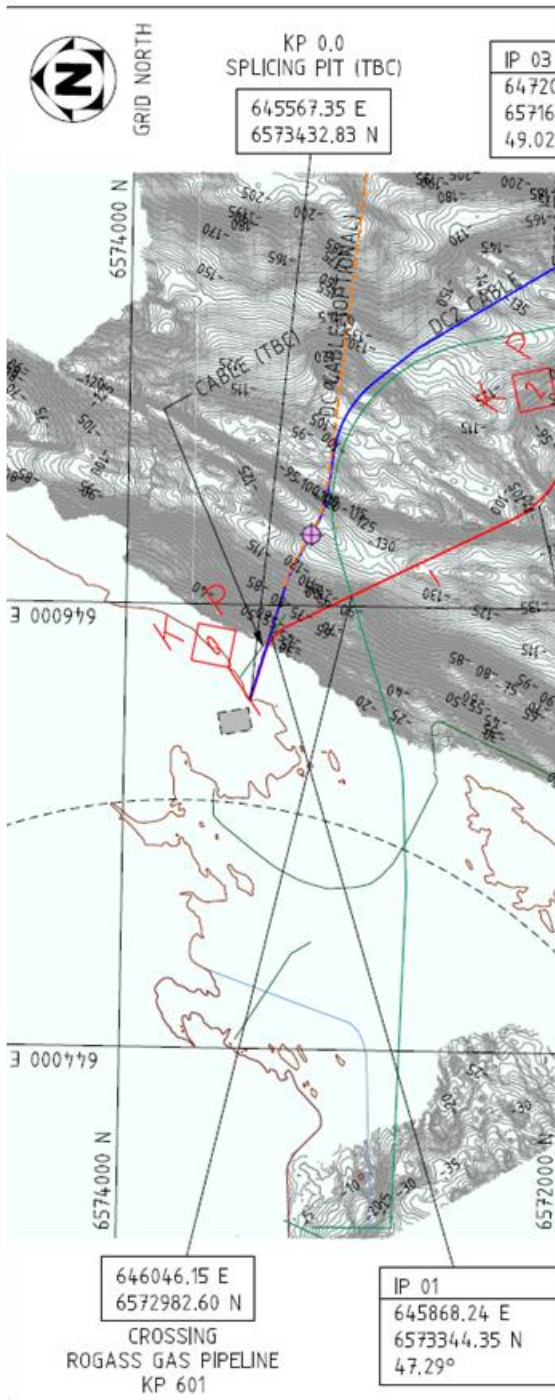

APPENDIX 3 CLARIFICATION 1

From: Heidi Ovidie Midbrød [heimi@statoil.com] Sent: fr 23.08.2013 14:11
To: Farhad Pakshad
Cc: Arno Pont; Jostein Nordland
Subject: RE: Track changes på final report?

Hei igjen.

Ref. diskusjon i møtet i dag.
Har sjekket internt hvor TR0926 gjelder i forhold til kravene til Statens Strålevern. TR0926 gjelder på våre anlegg innenfor gjerdet. Dvs at vi forholder oss til Statens Strålevern utenfor gjerdet på Kårstø og Haugsneset. Kan dere ta det inn i rapporten og sørge for at anbefalinger er iht det?

Best regards

Heidi Midbrød
HSE Manager
Utsira High Powerhub Project
Statoil ASA

m: +47 99158919
f: +47 51 99 00 50
e: heimi@statoil.com

Visitor address: Forusbeen 50, Forus
Incorporation number: NO 923 609 016 MVA
www.statoil.com

