

Langeled Project Marine Pipeline Environmental Statement

June 2004

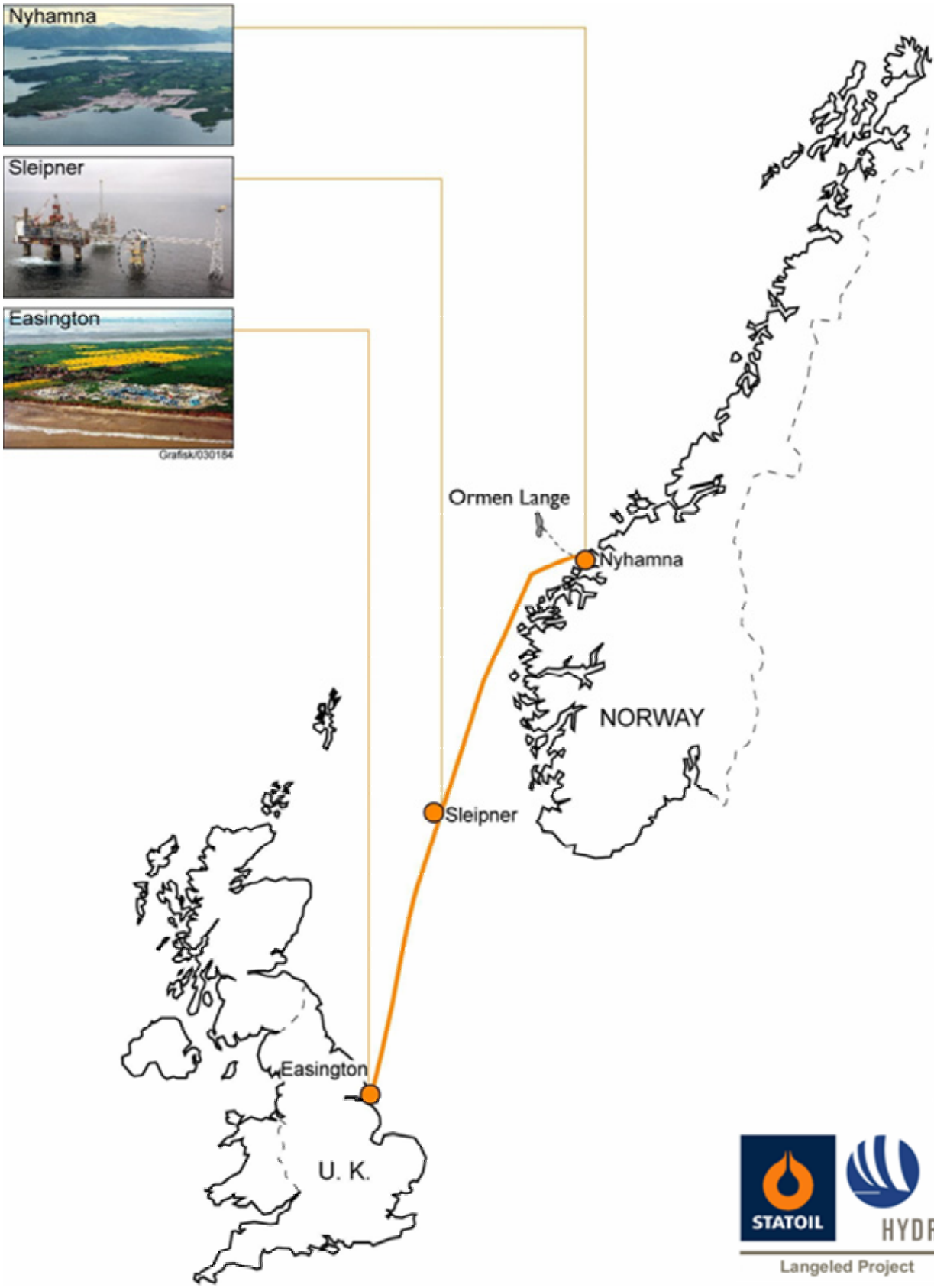

Langeled Project

Langeled Project Marine Pipeline

**UK/Norway Median Line to the UK Mean Low Water
Mark at Easington, East Riding of Yorkshire**

ENVIRONMENTAL STATEMENT

June 2004

This Environmental
Statement has been
prepared by Metoc plc
on behalf of The
Langeled Project



This page is intentionally blank

Standard Information Sheet

Project Name:	Langeled Pipeline
Project Reference No.:	D/2231/2004
Type of Project:	Dry Gas Pipeline
Undertaker Name:	Norsk Hydro Produksjon a.s
Undertaker Address	Norsk Hydro Produksjon a.s N-0240 Oslo Norway
Licensees/Owners	Statoil ASA Norsk Hydro Produksjon a.s Petoro AS AS Norske Shell Esso Exploration and Production Norway AS Norske ConocoPhillips AS BP Norge AS
Short Description	The proposed development is for a 44 inch pipeline stretching from the Norwegian Sector near Sleipner (Block 22) of the North Sea to facilities at Easington on the UK coast.
Anticipated Date for Commencement of Works:	Main project commencing April 2005; preparatory work offshore commencing January 2005.
Previous and other Statements Related to this Project:	Langeled Pipeline Landfall Environmental Statement – A. Wheeler & J. Mitchell Receiving Facilities Environmental Statement – RSKENSR
Significant Environmental Impacts Identified	The operation of the pipeline will not have any significant environmental impacts. Environmental impacts identified during construction are as follows. <ul style="list-style-type: none">• Limited direct mortality of benthic species notably sessile species, habitat loss, and potential small-scale changes in community structure due to construction;• The removal and disturbance of habitat is likely to cause direct and indirect short-term disturbance and may cause localised mortalities to individual crustaceans;• Displacement of vessels outside of the exclusion zone and potential increased fishing effort to the north and south; and• The loss of a section of key lobster area due to dredging work
Statement Prepared By:	Metoc <i>plc</i>

This page is intentionally blank

TABLE OF CONTENTS		Page
1	INTRODUCTION	1
1.1	Project Overview	1
1.2	The Need for the Development and Government Support	2
1.3	Purpose of the Marine Pipeline Environmental Statement	3
2	PROJECT OVERVIEW AND DEVELOPMENT OF ALTERNATIVES	4
2.1	Overview of the Langed Project	4
2.2	Project Alternatives	5
3	PROJECT DESCRIPTION	10
3.1	Construction	10
3.2	Operation	21
3.3	Decommissioning	21
3.4	Project Schedule	22
4	LEGISLATIVE AND POLICY FRAMEWORK	23
4.1	Legislation and Guidance Relevant to the Consent Application	23
4.2	Compliance with Other Legislation	23
4.3	Transboundary Environmental Impact	24
5	ENVIRONMENTAL IMPACT ASSESSMENT PROCESS	25
5.1	Screening	25
5.2	Scoping	25
5.3	Consultation	26
5.4	Assessment of Environmental Impacts	26
5.5	Impact Prediction	26
5.6	Impact Significance	27
5.7	Mitigation	27
5.8	Report Structure	27
5.9	Interface with Other Project Elements	28
6	PHYSICAL ENVIRONMENT	29
6.1	Methodology	29
6.2	Baseline Environment	29
6.3	Assessment of Impacts	40
7	CONSERVATION AREAS	44
7.1	Methodology	44
7.2	Baseline	44
7.3	Assessment of Impacts	54
8	BENTHIC ECOLOGY	55
8.1	Methodology	55
8.2	Baseline Environment	56
8.3	Assessment of Impacts	61
9	FINFISH AND SHELLFISH	65
9.1	Methodology	65
9.2	Baseline Environment	65
9.3	Assessment of Impacts	67
10	MARINE MAMMALS	76
10.1	Methodology	76
10.2	Baseline Environment	76

This page is intentionally blank

10.3	Assessment of Impacts	77
11	FISHERIES	79
11.1	Methodology	79
11.2	Baseline Environment.....	80
11.3	Assessment of Impacts	89
12	MARINE ARCHAEOLOGY	98
12.1	Methodology	98
12.2	Baseline Environment.....	100
12.3	Assessment of Impacts	107
13	SOCIO-ECONOMIC ACTIVITIES (OTHER THAN FISHERIES)	109
13.1	Methodology	109
13.2	Baseline Environment.....	110
13.3	Assessment of Impacts	115
14	ASSESSMENT FINDINGS	119
14.1	Physical Environment.....	119
14.2	Conservation Areas	120
14.3	Benthic Ecology	120
14.4	Fish and Shellfish	121
14.5	Fisheries.....	122
14.6	Marine Archaeology	123
14.7	Socio-Economic Activity (Other than Fisheries)	123
14.8	Residual Impacts.....	123
14.9	Cumulative and Transboundary Impacts	123
15	ENVIRONMENTAL MANAGEMENT	125
15.1	Project Environmental Management Plan	127
15.2	Schedule of Mitigation/Monitoring Measures.....	127
16	REFERENCES	129
Appendix A – Emissions and Discharges		133

This page is intentionally blank

1 INTRODUCTION

This document is an Environmental Statement (ES) of the proposed Langeled pipeline project in the marine environment, which is hereafter called the *Marine Pipeline ES*. It provides the findings from an Environmental Impact Assessment (EIA) of the proposed pipeline from the UK/Norway Median Line to the UK Mean Low Water Mark (MLW) at Easington, East Riding of Yorkshire.

1.1 Project Overview

A consortium of Norwegian petroleum exploration and production companies has been formed to exploit the reserves of the Ormen Lange gas field, which is located on the Norwegian Continental Shelf off the coast of central Norway. The gas from the Ormen Lange Field will be processed at a new gas terminal to be constructed at Nyhamna in Norway. The consortium wishes to export natural gas from Nyhamna to the UK through a new marine pipeline to Easington on the east coast of England. The pipeline will have an approximate length of 1200 km and deliver gas to the UK National Transmission System. The pipeline will be referred to as Langeled and be organised as a joint venture separate from the Ormen Lange field development. The Ormen Lange owners are; Petoro AS; Statoil ASA; Norsk Hydro Produksjon AS; AS Norske Shell, BP Norge AS and Esso Exploration and Production Norway AS. One additional partner is investing in Langeled; Norske ConocoPhillips.

The responsibility for the development and operation of Langeled is shared between two organisations. Norsk Hydro is the development operator for both the Ormen Lange field and Langeled until the pipeline becomes operational. Langeled will then be operated and managed by Gassco from its existing control centre in Nord-Rogaland, Norway.

The construction of Langeled from Nyhamna up to and including the receiving facilities and onshore line in Easington will be the responsibility of the Langeled Project, which is organised as a joint project between Norsk Hydro and Statoil. As development operator, Norsk Hydro has delegated the planning and execution of the transport project to Statoil, who has in turn, created a project team drawing staff and expertise from both companies. This is in order to ensure optimum utilisation of available expertise through use of Statoil's resources and to frame agreements for the delivery and installation of large diameter pipelines. The project is run under Statoil's management systems.

1.1.1 *Co-operation between Norway and the UK*

In October 2003 the UK and Norwegian Energy Ministers issued a joint statement on building co-operation in the North Sea¹. The main element was the announcement of the key principles to be incorporated in a future treaty between the two Governments.

The key principles of the treaty support the construction of Langeled, subject to receipt of all other statutory approvals, including planning permission. The UK and Norwegian Governments welcomed the Langeled Project as a major example of strengthening the cross-boundary development co-operation between the two countries.

¹ Building UK – Norwegian Co-operation in the North Sea, Oslo, 2 October 2003.

1.1.2 The Parts of the Project within the UK

Within the UK there are three distinct parts of the Langeled Project each of which is subject to separate applications and supporting EIAs.

- A **marine pipeline** from the UK/Norway Median Line across the UK Continental Shelf to the UK mean low water (MLW) is the subject of a Planning Application submitted to the UK Department of Trade and Industry (DTI). Part of the planning application involves the submission of two key documents: this ES, which has been prepared in accordance with the relevant regulations² and a Pipeline Works Authorisation (PWA), which forms a separate document.
- A **pipeline landfall** at Easington which is the subject of a Planning Application submitted to the East Riding of Yorkshire Council. This covers the works from MLW to the boundary of the new onshore gas receiving facility. An ES has been prepared in accordance with the relevant regulations³ and forms part of the application for planning permission.
- A **new gas receiving facility** and export pipelines at Easington, which are the subject of a Planning Application submitted to the East Riding of Yorkshire Council. An ES has again been prepared in accordance with the relevant regulations³ and forms part of the application for planning permission.

1.2 The Need for the Development and Government Support

1.2.1 UK Natural Gas Demand and Supply

Following the successful development of the North Sea oil and gas, the UK has been a net exporter of gas for the past two decades. However, whilst forecasts vary, it is agreed that UK gas production will decline significantly over coming years.

In the development of the UK's Energy Policy⁴ one of the key concerns is the decline of the UK's natural gas supplies. A projection of future UK gas demand and supply is shown in Figure 1.1.

The UK Government anticipates that the UK will become a net annual importer of gas by 2006, with a large and growing import requirement by the end of this decade and beyond. By 2020 the Government has acknowledged that:

- around three-quarters of primary energy needs will be imported; and
- gas will form a large part of the energy mix.

The Government recognises that Norway could be a major source of our gas imports over the next decade and that the UK.

² Offshore Petroleum Production and Pipelines (Assessment of Environmental Effects) Regulations 1999 (SI 1999/360)

³ The Town and Country Planning (Environmental Impact Assessment) (England and Wales) Regulations 1999 (SI 1999/293)

⁴ Energy White Paper, Our Energy Future – Creating a Low Carbon Economy, February 2003

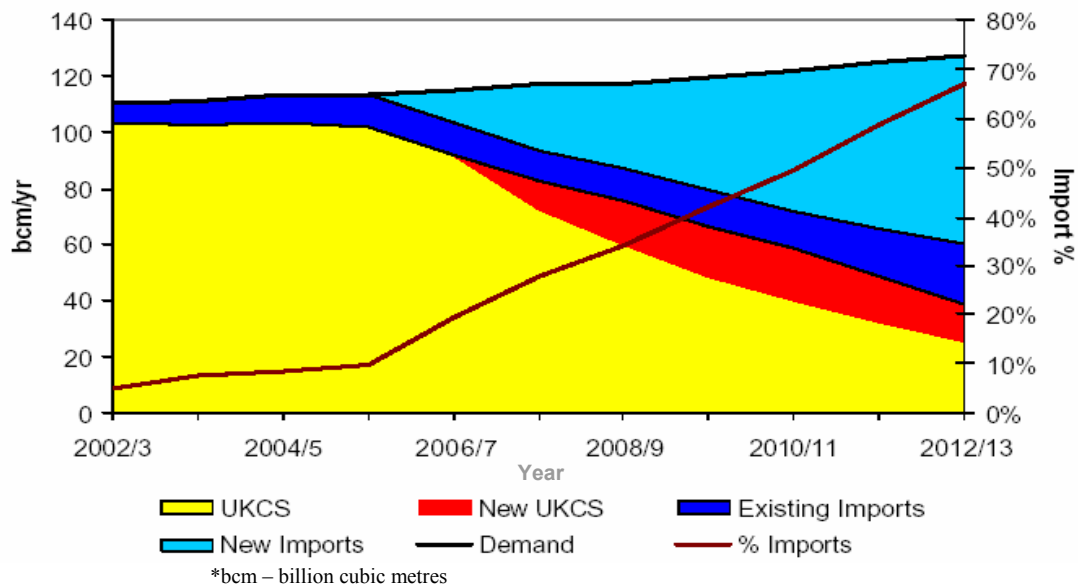

Figure 1.1 UK Natural Gas Demand and Supply

1.2.2 Reliability and Security of UK Gas Supplies

One of the goals of the UK’s Energy Policy is to maintain the reliability of energy supplies. The Government recognises that:

- reliable energy supplies are fundamental to the economy as a whole and to sustainable development;
- an adequate level of energy security must be satisfied at all times in both the short and longer term; and
- the provision of timely new infrastructure will be important in ensuring gas supply flexibility.

It is important for security of supply that “a sufficient proportion of the gas importation projects currently under consideration proceed to full-scale development in a timely fashion⁵” (DTI/OFGEM, 2003).

1.3 Purpose of the Marine Pipeline Environmental Statement

The *marine pipeline* ES is intended to meet DTI requirements for environmental approval and as such its general objectives are to:

- establish and review the existing environmental conditions along the route of the proposed marine pipeline;
- identify and assess any environmental impacts that might arise during construction, commissioning and operation of the proposed development; and
- assist in establishing appropriate measures to mitigate any adverse effects.

⁵ DTI/OFGEM Joint Energy Security of Supply Working Group (JESS) Third Report, November 2003

2 PROJECT OVERVIEW AND DEVELOPMENT OF ALTERNATIVES

2.1 Overview of the Langeled Project

The purpose of the Langeled transport system is to transport gas produced from the Ormen Lange Field in Norway to market delivery points in the UK and Continental Europe, in addition to transporting gas from other Norwegian sources to the UK market. To achieve this the installation of a new pipeline is proposed from the Ormen Lange gas-processing terminal at Nyhamna in Norway to the Sleipner Offshore Installation on the Norwegian Continental Shelf and then on to Easington, East Yorkshire.

The connection of Gassled (the existing Norwegian gas transport grid) to the Sleipner riser platform would make it possible for gas shippers from other sources on the Norwegian Continental Shelf to access the UK market and for Ormen Lange gas shippers to access existing Gassled delivery points in continental Europe via Langeled.

Langeled will consist of the following elements.

LANGELED NORTH

Entry Point – Outlet of the Ormen Lange processing terminal at Nyhamna in Norway. This will include all necessary equipment for transmitting pipeline integrity gauges (pigging) and inspection equipment.

42” Northern Pipeline – pipeline from the entry point at Nyhamna to the Sleipner Riser platform.

SLEIPNER NODE

Sleipner R Tie-In – integration with the existing Gassled transport system on the Sleipner Riser platform via a Subsea Valve Station (SSVS).

LANGELED SOUTH

44” Southern Pipeline – pipeline from Sleipner R to the UK.

Receiving Facility – onshore receiving facility at Easington in the UK where the gas will be adjusted to the correct temperature and pressure before is it transferred to the UK National Transmission System.

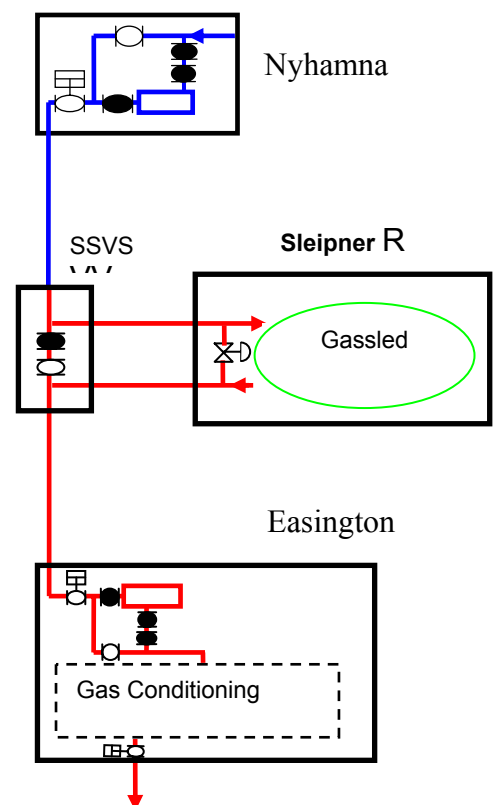

2.2 Project Alternatives

2.2.1 Background

Extensive studies were undertaken between 1999 and 2003, which addressed the financial, technical, environmental and social aspects of a wide range of options. The main criteria used in the decision process were environmental issues gas transportation requirements, lifecycle costs through the whole transportation chain from field to market delivery points and risk exposure. Environmental criteria were central in the selection of the pipeline route and in the location of the landfall and gas receiving facility.

The selection process started with the identification of options in 1999, and continued with more detailed screening and assessment in 2001 and 2002; the general concept was selected in 2003 (Figure 2.1).

2.2.2 Strategic Alternatives

A considerable number of options were identified during the early study phases: All of these options had a pipeline from the Ormen Lange Field area to a connection point on the Norwegian offshore dry gas system, and then an export route to the UK or Continental Europe.

The pipeline routing options were assessed in parallel to a range of system volume requirements. The selected option had to provide sufficient capacity to meet both the requirements of the Norwegian gas shippers while considering future UK and Continental Europe markets.

Four possible connection points on the Norwegian gas system were identified. These were the offshore installations at Oseberg, Heimdal, Draupner or Sleipner. These were considered as 'node points' in the pipeline infrastructure. The onward link to the UK would then be via connection to one or more of the existing gas pipelines or, alternatively, via a new high capacity pipeline.

The screening process continued throughout 2001 and 2002 with the system capacity, node points and pipeline links, being identified and evaluated. This led to a shortlist of feasible alternatives. The selected alternatives were developed in greater technical and commercial detail to allow the concept selection to be made in early 2003. Selection of capacity and final definition of the pipeline system was completed in the second quarter of 2003.

2.2.3 Connection to the Norwegian Pipeline System

During the screening process, the respective licensees were invited to describe their solutions to accommodate a connection to Langeled. The Ormen Lange partners concluded that they should pursue the Draupner and Sleipner options further, as these would provide the highest capacity and flexibility and the best market access. The two options were also competitive in terms of costs. During 2002, further engineering studies were carried out with tie-in and operation agreements being negotiated with the owners of Sleipner and Draupner platforms. These studies and agreements formed the basis for the final selection.

The increased gas volumes that could be offered to the UK market and the higher flexibility of the Sleipner option in terms of future tie-ins to infrastructure on the UK side were among the reasons for selecting Sleipner R offshore installation.

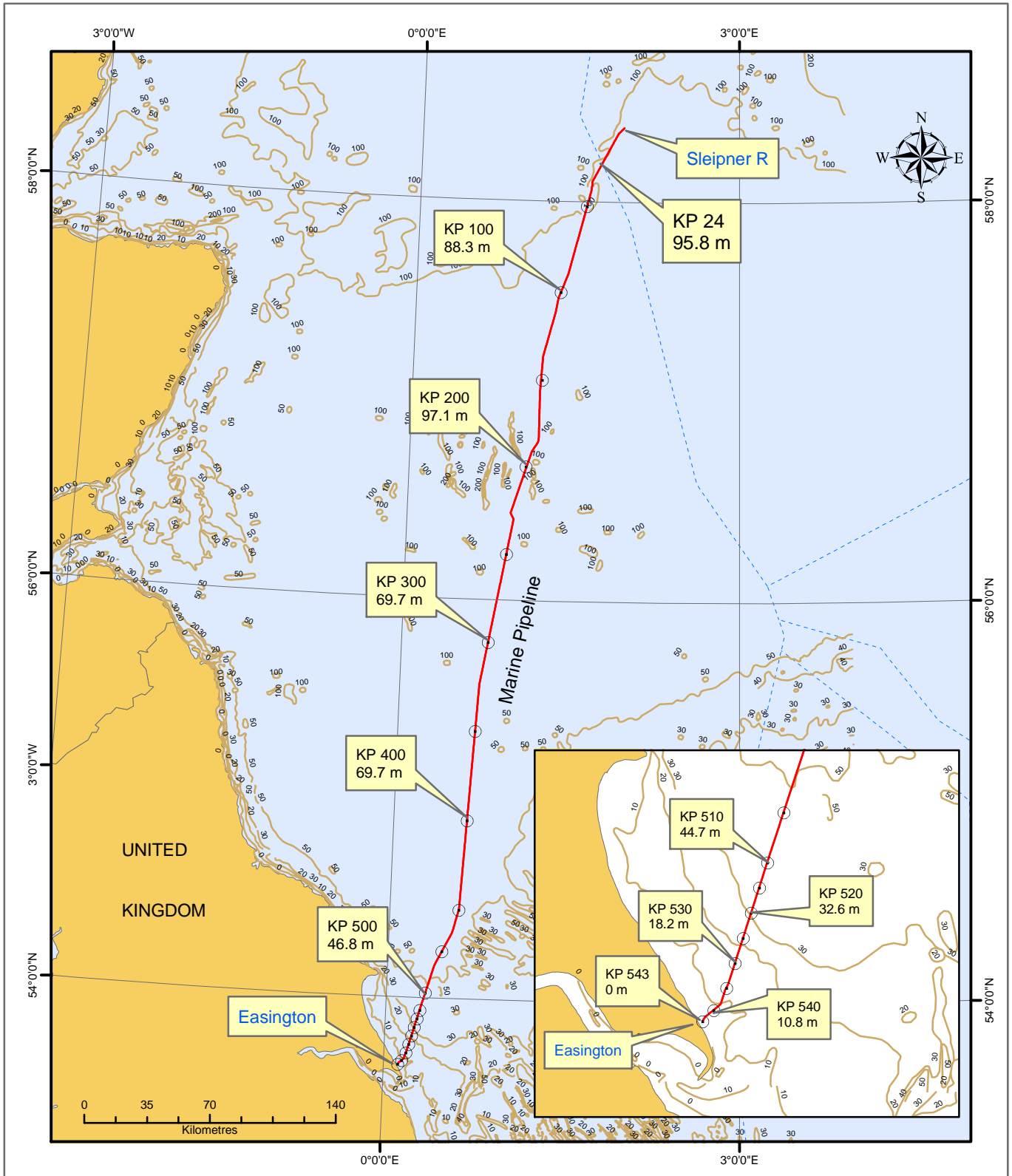

Figure 2.1. Marine Pipeline Route Map (General Concept)

Legend

- Kilometre Point
- Southern pipeline system (OLT38)
- Bathymetry (m)
- - - Transboundary line
- Land

Date	24/January/2004	
Projection	UTM Zone 31N	
Spheroid	International 1924	
Datum	ED 50	
Data Source	Metoc Charts, CMap_V2, Statoil-Norsk Hydro	
File Reference	I:\..\P517\proposedpipelineoverview.mxd	
Checked	Jillian Barnes Philip Wemyss	GIS Specialist Project Manager



2.3.4 Evaluation of existing pipelines on the UK Continental Shelf

Initial studies in 1999 identified a wide range of options for tie-in to existing pipeline systems on the UK Continental Shelf (UKCS). The evaluation continued during the 2001 and 2002 screening process and included a thorough examination of all the available options for transporting gas from the Norwegian Continental Shelf, via the existing UKCS pipelines. The relevant pipeline operators on the UKCS were contacted to provide an overview of available transportation capacity, estimated tie-in costs and estimated transportation tariffs. Most of the UK systems were screened out, mainly due to high connection costs and limited capacity.

Of the more than 15 systems initially included in the early studies, only the Miller Gas Transport System (MGS) and Central Area Transport System (CATS) were considered appropriate, as they were the only large systems that could meet the transportation requirements. The Shearwater Elgin Area Line (SEAL) was added when it became evident that neither CATS nor MGS above could offer sufficient capacity.

At the onset of the studies it was expected that the use of an existing system would be efficient in terms of limiting capital expenditure and overall transport cost. However, the combination of the tariff for gas transport that was offered, as well as the lack of capacity and the investments required to establish the necessary tie-ins and system modifications, resulted in a higher transport cost than a new-built direct pipeline. Consequently, the option of using existing UKCS infrastructure was concluded not to meet the requirements of the project.

2.3.5 UK Pipeline Landfall Alternatives

In parallel with the studies on existing pipeline options, a new pipeline to the UK was also studied and developed.

Possible landfall sites and access routes for a direct pipeline into an existing landfall location in the UK were investigated thoroughly. Along the East Coast of the UK the established landfall points for gas are St Fergus (Scotland), Teesside, Easington (East Riding of Yorkshire), Theddlethorpe (North East Lincolnshire) and Bacton (Norfolk). These landfall points tie-in to the UK's established onshore pipeline network for the transportation of natural gas, the National Transmission System (NTS), operated by National Grid Transco.

Options were considered for Langeled, which included both the use of existing terminals and the possibility of constructing a new receiving terminal on a green field site. It was considered that the establishment of a completely new landfall complex on the East Coast would be complicated in land use planning terms and consequently the establishment of a new landfall location and terminal was excluded as a viable alternative. The preferred alternative was to pursue a landfall at one of the existing terminal locations.

Routing the pipeline to a gas terminal at either St Fergus or Teesside was considered. However, the NTS gas transport tariffs and the cost of other investments that would be required to establish a link to consumers in the southern part of the UK were greater than the costs of a new Marine Pipeline routed directly to a more southerly gas terminal. Consequently, these more northerly options were rejected.

In the final concept selection phase, the owners of gas terminals at Easington, Theddlethorpe and Bacton were invited to submit offers for the provision of services to receive the gas. The engineering feasibility and environmental aspects of a new pipeline landfall and expansion of the existing terminal facilities were also considered. The environmental studies considered the avoidance of designated conservation areas, likely construction and operational impacts and disturbance to the local community.

The Bacton area was screened out due to technical and commercial factors.

The Theddlethorpe terminals were also screened out, based on a combination of environmental concerns around the crossing of the sand dunes, the long shallow water approaches and commercial considerations.

Of the alternatives the Easington site was considered to be the best environmental option for a new pipeline landfall. It will avoid areas designated at a National level for their nature conservation value, and the pipeline approach will require the least amount of dredging. In addition, the proposal made by the Easington terminal owners would provide the landing of a new pipeline at the most competitive commercial price.

The investigation's therefore concluded that a new pipeline system linked to the Sleipner R platform and continuing to Easington would be the most cost-effective solution whilst being the preferred environmental option. The selected option and the existing North Sea pipeline routes are shown in Figure 2.1.

2.3.6 Pipeline Landfall Alternatives at Easington

An engineering study identified three possible pipeline landfall locations in the vicinity of the Easington complex. The alternatives were:

- a northern route to the north of BP Dimlington Gas Terminal, close to Warmer Lane;
- a central route to the east of Dimlington Gas Terminal (the selected option); and,
- a southern route to the south of the Centrica and BP Easington Gas Terminals

The alternatives were considered and the results of the evaluation are described below.

Northern Alternative

The northern alternative was a suitable landfall for a pipeline into the BP Dimlington Gas Terminal, but to access the new Centrica Receiving Facilities the pipeline would have considerably longer cross-country route, to the West of the BP Terminal. The Dimlington Cliffs are designated as a Site of Special Scientific Interest (SSSI) for their geological interest. The designated area extends to the low water mark and the landfall works would have resulted in some disturbance to the foreshore within the SSSI area. For these reasons, the northern alternative was not considered to be the best landfall option.

Central Alternative

This alternative has been selected as the most favoured landfall location. A landfall to the east of the BP Dimlington Terminal presented the advantages of avoiding incursion into the SSSI to the north, and minimising the length of the onshore section of the pipeline route to the new

Receiving Facilities. The Marine Pipeline approach to the landfall would require an offshore crossing of an existing BP pipeline, but this could be achieved with a minor deviation to the direct route. Further offshore, the pipeline route is constrained by adjacent seabed features of outcropping rocks and sand waves. The pipeline would have to be routed between these features, resulting in an alignment that also favours the selected alternative.

Southern Alternative

The southern landfall option would have resulted in the new pipeline being constructed immediately north of Easington Village. The close proximity of the pipeline to residential areas had the potential to present a greater level of risk to the local community; this option was therefore dismissed early in the screening study.

3 PROJECT DESCRIPTION

The *marine pipeline ES* addresses the potential impact of the Langeled development from the UK/Norway Median Line through to MLW at the Easington shoreline, a distance of approximate 520 km.

The pipeline will be made of carbon steel with a diameter of 44 inches (constant inner diameter of 1066mm) and a wall thickness of 25–30 mm. The design pressure will be 156.8 barg and the design temperature will be between -10 °C and +50 °C. The operating temperatures will be more conservative than the design envelope.

The pipeline will have external corrosion protection provided by a coating of asphalt, plus a stability coating of concrete. External cathodic protection will also be provided in the form of sacrificial anodes. The pipeline sections within the landfall works will have designed coatings to suit the construction and operational requirements.

This section provides an overview of the details of construction, installation, commissioning and operational techniques. It is structured as follows.

- Construction.
- Operation.
- Decommissioning.
- Project schedule.

3.1 Construction

The pipeline will be laid through a range of environments that require different engineering approaches and intervention works. These intervention works refer to seabed engineering works that are necessary to ensure pipeline stability and integrity. Throughout this section kilometre points (KP) have been used and are shown in Figure 2.1. The construction details are divided into five stages:

- general overview of seabed intervention work;
 - pre-pipeline installation intervention works;
 - pipeline installation;
 - post pipeline installation intervention works and reinstatement; and
 - other construction features.
- Appendix A provides estimates of emissions that would be expected during the various construction stages of the pipeline.

3.1.1 *General Overview of Seabed Intervention Works*

For the majority of the route the pipeline will be laid directly on the seabed. However, some seabed intervention works will be required, which will be as follows.

- **KP 23 (entry UK sector) to KP 451 (66 m water depth).** Up to 50 km of post-lay spot trenching at intermittent locations will be required for on-bottom stability (in chalk and clay areas), and possibly freespan correction. The results from the geotechnical

investigations are being evaluated. The trenching will be optimised based upon these results.

- **KP 451 to KP 521.** Pre-lay sweeping will occur within sandwave areas and areas where the seabed is uneven. This comprises spot sweeping in depths up to 5 m and a fixed width of approximately 15 m. This will level the seabed to allow post-lay trenching operations. The removed sand will be deposited on the seabed alongside the trench semi-continuously at sufficient distance to prevent the deposited materials naturally backfilling prior to pipe-lay. After pipeline installation (post-lay) the whole section will be continuously trenched.
- **KP 521 to KP 528.** Either post-lay trenching or pre-dredging a trench will be performed in this section. The volumes shown in Table 3.1 assume dredging is undertaken; however, if practical, trenching will be considered further as this will reduce the volumes. The adopted methods will be selected based on the results of the geotechnical investigations.
- **KP 528 to KP 543 (90 m distance from the MLW mark).** Pre-lay dredging to depths up to 2 m will occur from KP 528 up to 640 m from the MLW to protect the pipeline and ensure that it does not become exposed during its operational lifetime. 640 m from the MLW mark, extending 550 m to the lower end of the cofferdam (see below), a floating channel⁶, 160 m wide at its maximum, will be dredged to allow access for construction vessels close to the shore. The depth of the floating channel will gradually increase shoreward from 0 m up to 6 m, whilst its width will correspondingly decrease. Within this channel a pipe trench will be dredged 10 m wide and approximately 4 m deep.
- **KP 543 to MLW.** The last 90 m up to the MLW mark will be constructed using a wet cofferdam, which has a bottom width of 5 m. The cofferdam is required to prevent natural backfilling and retain the depth of the dredged channel until the pipeline can be laid.

Table 3.1 Seabed Intervention Work along the Route

Kilometre Point (KP)	Water Depth (m)	Activity	Maximum Volume of Spoil Removed (m ³)
23-451	96-64	Up to 50 km of spot post-lay trenching at spot locations	300,000 ⁷
451-521	64-29	Pre-lay sweeping in sandwaves (0.5 – 5 m deep trench) , and area with uneven seabed and Post-lay trenching, 1-2m deep	300,000 700,000
521-528	29-20	Pre-dredging ⁸	250,000
428 upto the cofferdam (inc the 550 m floating channel.	20-5	Pre-dredging and floating channel construction	700,000
Last 90 m – to the MLW mark	5-0	Cofferdam Construction	3,000

3.1.2 Pre Pipeline Installation Intervention Works

Pre-Lay Sweeping

For the majority of the route from the UK/Norway Median Line up to the area of sandwaves between KP 451 and KP 521 the seabed is generally flat and comprises sandy sediments of varying consistency. Within this region design studies predict that the pipeline will naturally embed up to half its diameter into sediments within one-to-five years after installation. Conversely, erosion may also cause temporary freespans at some locations. The proposed

⁶ This channel will allow the cutter suction dredger to approach closer to the shoreline and speed up the dredging operation; shortening the overall landfall pipeline construction programme.

⁷ There will be no spoil removal for this process

⁸ This section may also be trenched depending on the results of the geophysical survey.

intervention work will be sufficient to prevent any spans that may periodically form from being below the critical height of 0.75/0.80 m (see Section 11.3.2). Experience with other large diameter pipelines in the North Sea has demonstrated that spans may appear and disappear over a cycle of perhaps two-to-three years.

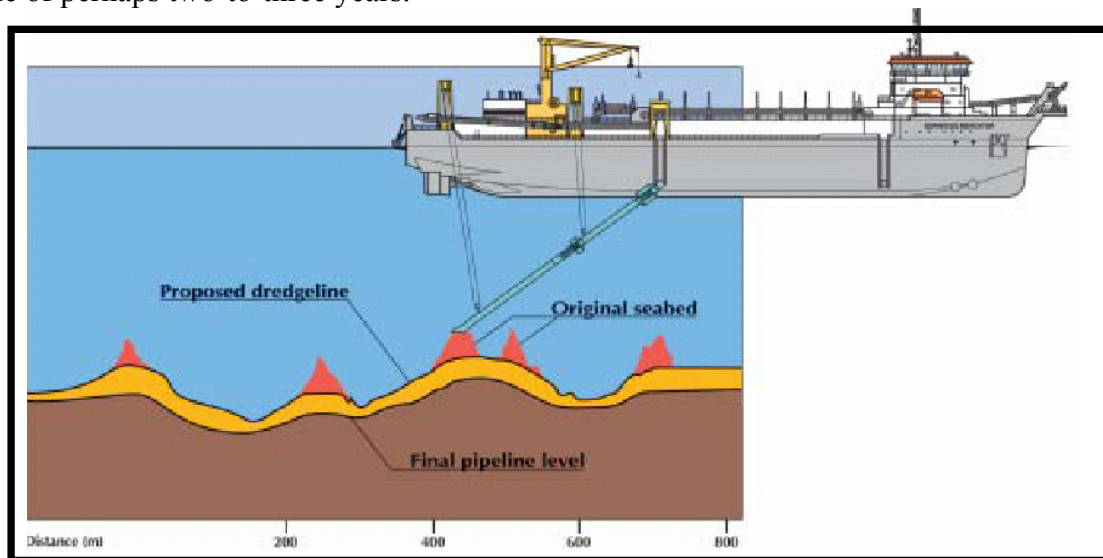

Figure 3.1 Pre-Lay Sweeping

Pre-Dredging

From *KP 521 to approximately KP 542* the pipeline will be buried by pre-dredging a channel to a depth of 2 m using cutter suction dredging techniques. The associated volumes are shown in Table 3.1. An indication of the dredging method is given below in Figure 3.2.

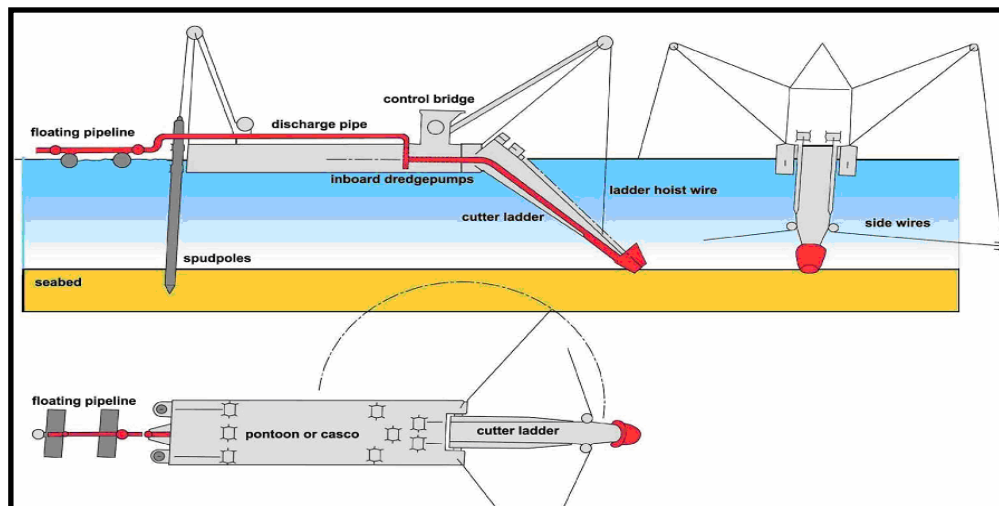

Figure 3.2 Dredging Method

The dredged material will be removed from the seabed, by way of a suction pump, and temporarily placed to the southerly side of the channel to minimise natural backfill in the trench prior to pipelaying. The entire trench will be backfilled after the pipeline has been installed using this spoil material. Up to approximately KP 528, the channel will have a residual width of 10 m, formed through cutting an initial box-channel 15 m wide and 2 m deep, which will then naturally erode to the bottom width. Beyond this point up to KP 542 the bottom width will be narrower (5 m) formed through cutting a 10 m wide channel, which is also 2 m deep.

From *KP 542 – KP 543* the cutter-suction dredger will be required to access the shallow water close to the end of the cofferdam because it needs 3 m hull clearance at all states of the tide. This will be achieved by dredging a 160 m wide floating channel (at its maximum) for 550 m up to the cofferdam using the cutter-suction dredger. The floating channel will vary in depth and width to provide adequate clearance whilst ensuring safety and manoeuvrability. Specifically, the dredged depth in the floating channel increases towards the shore from 0 m to 6 m where it ends 90 m from the MLW mark, namely at the limit of the cofferdam, whilst the channel width decreases in this section from 160 m at its outer end to 5 m where it joins the cofferdam. This chosen method of construction has minimised the duration of the dredging works to approximately one month, far quicker than any other considered alternatives.

The trench depth will ensure that the pipeline does not become exposed during its operational lifetime of fifty years⁹. In addition, the cutter suction dredger will excavate a pipeline trench approximately 1,200 m from the MLW mark, which will be 10 m wide. The depth will suit burial requirements, including the predicted erosion rates, and will thus be approximately 4 m at its furthest point offshore¹⁰. As the floating channel becomes deeper the pipeline trench will shallow off to a point where the floating channel is sufficiently deep to lay down the pipeline on the excavated seabed. This is shown in Figure 3.3.

Dredging operations in this region will take place immediately prior to the arrival of the shallow water lay barge (see below); thus, minimising the requirement to remove any sediment build-up from the trench.

Excavate will be removed from the floating channel preferably using a floating pipeline, which will deposit the spoil directly on the seabed. If necessary, barges may be used for this process. Approximately 75 % of all spoil will be stored within the excavated floating channel whilst the remainder will be temporarily placed within the 200 m pipeline corridor. In all instances the materials will be stored to the south of the works and used as backfill after the installation is complete. Backfilling will be achieved through using the dredging hose on the trailer suction hopper dredger, which will also level the seabed. The excavate will be dumped from the open hopper in the very shallow sections. For the deeper water backfilling will be done from the hopper through the fall-pipe. Proposed temporary storage areas for spoil are shown in Figure 3.3.

This method of pipeline installation is consistent with previous techniques used at Easington.

⁹ This is the only section (1.2 km from the MLW mark) where the pipe has been actively designed not to become exposed during operation.

¹⁰ Given the clay geology in the region, the cutter-suction dredger will cut the trench leaving vertical sides, unlike further offshore where a 1 in 3 slope will be formed. The overall concept is the over-width channel of 10 m can accommodate some degree of silting prior to the pipe pull in operation

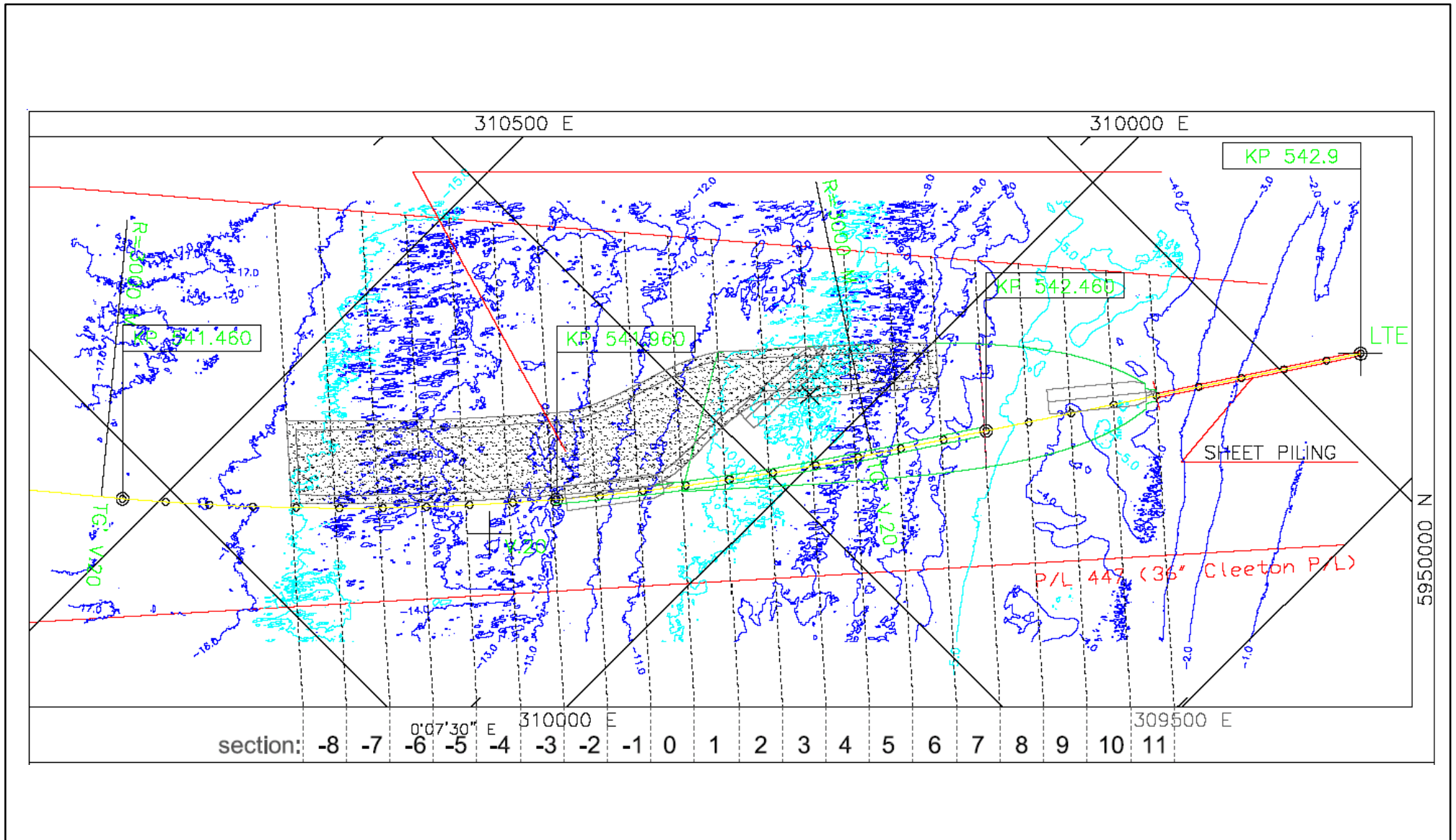

Checked By	GIS Specialist	Project Manager
	David Sinclair	Date 23/06/2004

Datum	ED 50*	Spheroid	Intl 1924*
Projection: UTM 31 N*			
File Reference P517a\GIS\Figure 3.3...mxd			
Data Source SeaZone Solutions Limited, CEFAS			

Figure 3.3 Temporary deposit of dredged materials from floatation channel



* Assumed based on previous data provided by Stat Oil.

Cofferdam Construction

The total length of the cofferdam is 240 m, of which the last 90 m lies beyond the MLW mark. The cofferdam will be constructed in two parts: a dry part (150 m in length) and a wet part (90 m in length)¹¹. The dry section will be constructed and excavated using a crane with a piling hammer and a grab bucket, respectively, whilst the wet section will be constructed using similar equipment mounted on a jack-up or pontoon. The spoil will be stored on the bench or to the south side of the cofferdam.

3.1.3 Pipeline Installation

According to the current plan the pipeline installation will be as follows.

Deeper Water Installation

The deep water lay barge (Stolt Offshore LB200 see Figure 3.4) will begin pipelaying at Sleipner and proceed southwards, entering UK waters at approximately KP 23 (90 m water depth). Pipelay will continue southwards to around KP 360 where it will lay down the pipeline temporarily. The lay barge will reposition to KP 528 (22 m water depth) where it will pick up the pipeline that has been installed by a shallow water barge (see below). The pipelaying will then move northwards towards the mid-line tie-in location, which is presently expected to be about KP 410 (73 m water depth) where the pipeline will be permanently laid down. The barge will then reposition to KP 360, where it will pick up the temporarily laid-down pipeline and recommence pipelaying southwards to the mid-line tie-in point. At the mid-line tie-in point the pipeline will be joined through hyperbaric welding.



Figure 3.4 Stolt Offshore LB200 Lay Barge

Shallow Water Installation

The shallow water lay barge, the Tog Mor, will anchor as close to the shore as practical. Pre-coated pipe joints will be welded together onboard the vessel (see below) and pulled ashore by a land-based winch. The shallow water lay barge will then continue to lay the pipeline out to a water depth of approximately 22 m (KP 528) where the pipeline end will be capped and temporarily laid on the seabed.



Figure 3.5 The Tog Mor

Standard Installation Techniques

The sequence of key activities that occur on the lay barges are as follows:

- receiving line pipe joints from pipe carrier vessels;
- welding of pipeline sections;
- coating of welded field joints; and
- laying of the pipeline.

The individual line pipe joints are pre-coated prior to their transportation to the lay barge, with only the ends left un-coated to allow welding. These will be coated after the pipeline sections are joined on the lay barge. To allow continual laying each lay barge will be typically supported by a number of vessels including anchor handling tugs, survey vessel, and pipe carriers.

Each lay barge will be held in position by anchors, which will control and restrict its movement to ensure the pipeline is laid in its correct position and to avoid undue stress on the pipeline as it is being laid. The pipeline is tensioned by grippers on the barge to secure the pipeline and control the “S” configuration as it is laid out along the stinger to the rear of the vessel.

On the deepwater lay barge each anchor has an operational anchor wire that will be approximately 10 times the water depth at any given point; which at its maximum will be 1000 m either side of the pipeline around the northern section of the pipeline (KP 161, see Section

6.2.1). The shallow water lay barge will have an anchor corridor width of 500 m in total¹². The anchor points will only be laid at predetermined locations around the barge in critical areas along the route otherwise they will be laid at the bargemaster's discretion¹³. The barge is pulled through the water by gradually increasing the tension on the forward anchors whilst paying out the stern anchor wires. Using this technique, it is predicted that the LB 200 will lay pipe at a rate of 2-4 km per day whilst the Tog Mor will proceed at 500 m per day. The anchors used for this operation will be of the Delta Flipper type. These are designed to reduce dragging along the seabed and minimise scars. They can penetrate the seabed to a depth of up to 5 m.

3.1.4 Post Installation Intervention Works and Reinstatement

Post-Lay Spot Trenching and Post-Lay Trenching

Once positioned on the seabed, it is expected that up to 50 km of the pipeline, between KP 23 and KP 451, will be post-lay trenched following a detailed stability evaluation. Beyond this point continual post-lay trenching will be undertaken up to KP 521; Which may extend to KP 528. The trenching operation will be undertaken using a plough (PL2 Advanced Pipeline Plough). If trenching operations create clay mounds then a backfill plough may be used.

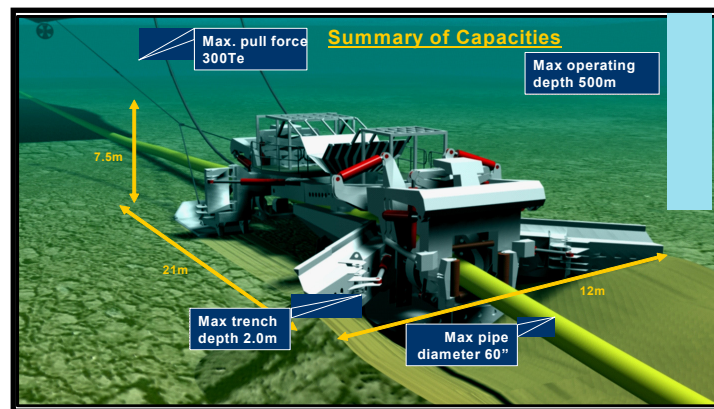

Figure 3.6 Plough Capabilities

A theoretical trench profile is shown in Figure 3.7. The actual dimensions will depend on the mobility of the soil and sediments.

¹² This is not to be confused with the total exclusion width of 1km as this allows for other support vessels to freely move round the shallow draft lay barge.

¹³ Anchor points around the Tog Mor barge will be predetermined based on surveys carried out for this project.

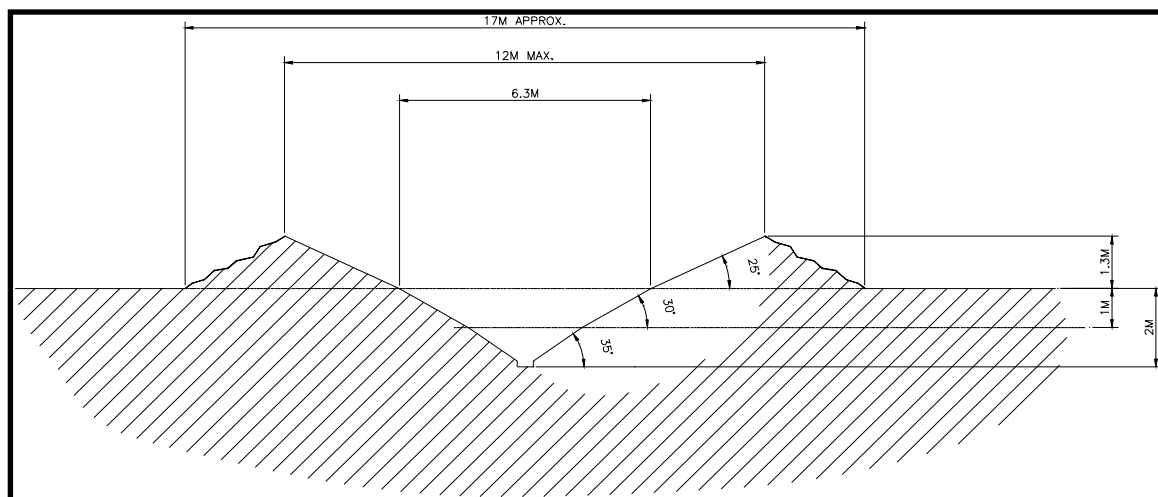

Figure 3.7 PL2 Advanced Pipeline Plough Theoretical Trench Profile

3.1.5 Other Construction Features

Crossings

The pipeline will cross a number of existing pipelines and cables. The general method when crossing pipelines and cables is to secure a positive clearance between the existing structure and to avoid point-loads on it. Pre-lay gravel and/or concrete mattresses are normally used for this operation. Details of the crossing construction and the range of dimensions are given in Table 3.2. A total gravel volume of 50,000 m³ is estimated for the crossings.

Each crossing will be individually designed to ensure that the integrity of the existing infrastructure is not affected by the works (see Figure 3.8), in accordance with any specific requirements of the crossed pipeline/cable owner(s) and to ensure overtrawlability.

Table 3.2 UK Sector Crossing Works

UK Sector Crossing Materials and Dimensions		
Description	Minimum Dimension (m)	Maximum Dimension (m)
Width of Top of Post-Lay Gravel Berm	4	6
Width of Base of Post-Lay Gravel Berm	14	34
Length of Post-Lay Gravel Berm	50	600
Height of Post-Lay Gravel Berm	1.6	3.5
Side Slope of Gravel Berms	1:3	1:3
Gravel size, d ₅₀ ¹⁴	75 mm	175 mm
Crossing Angle	24	76

The method used for crossing abandoned or disused cables depends on the status of the cable, exposed or buried, and if the crossed line will rest on the seabed or be lowered. All crossings of discussed cables will be in areas where the pipeline is not trenched; therefore, no intervention is planned, with the pipeline being lain directly over the structure.

¹⁴ Maximum diameter of 50 mm

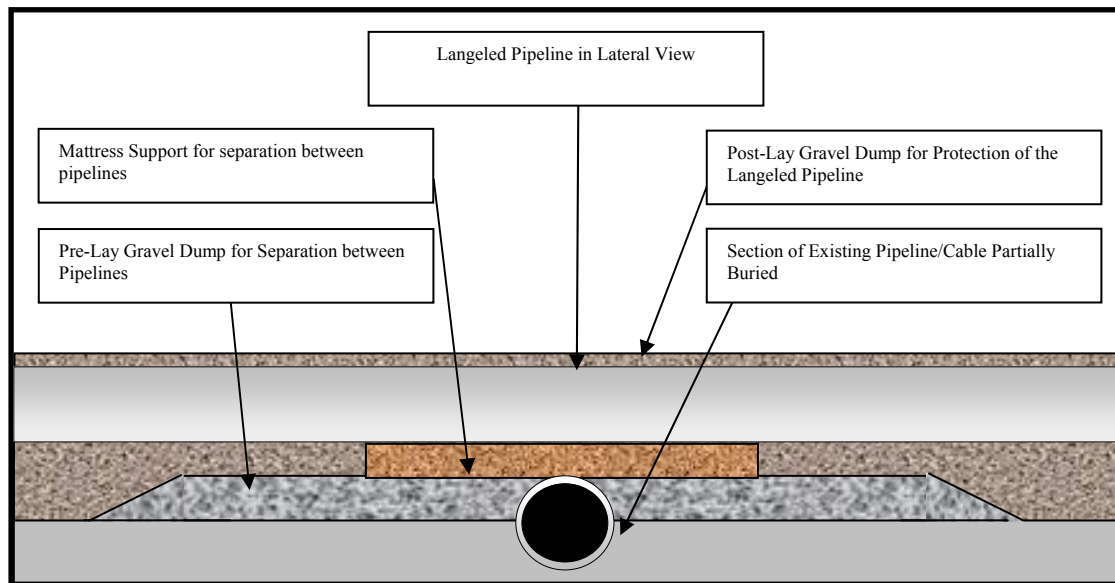

Figure 3.8 Typical Cable/Pipeline Crossing

Special Design Features

Design studies have indicated that in order to control pipeline displacement due to thermal expansion, it may be necessary to install discrete gravel berms along the pipeline immediately south of the Sleipner tie-in. Some of these berms (5 to 10 in number and varying from 200 m to 500 m in length,) may be located within the UK Sector in approximately the first 5 to 10 km from the Median Line. A total gravel volume of 90,000 m³ is estimated for these gravel berms. Further studies will be carried out to clarify the necessity for the gravel berms.

Two 'T'-pieces will be installed along the marine pipeline at approximately KP 55 and KP 155 to allow future connections into pipeline system. The T-pieces will comprise a section of increased wall thickness, and a capped short branch installed vertically. The overall dimensions, above the existing pipeline, are approximately 1-1.5 m high and 1 m long, and each unit will be encased in a protective overtrawlable structure. For additional safety reasons rock dumping may also occur over the entire structure. A typical T-Piece is shown in Figure 3.9.

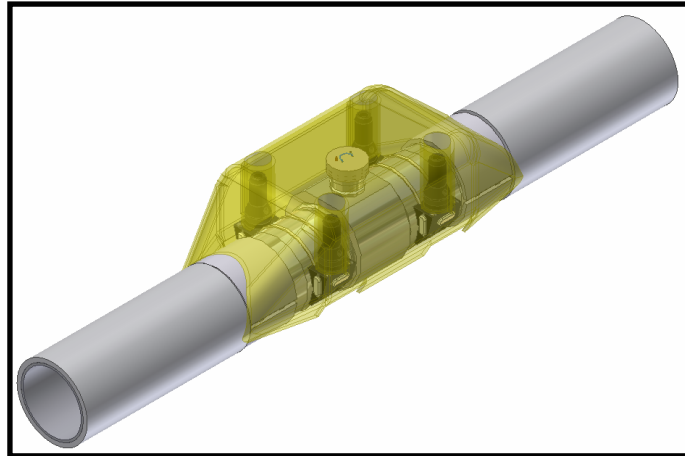

Figure 3.9 Typical T-Piece

Within the last 1-1.5 km of the pipeline, up to the cofferdam, gravel will be placed on the exposed pipeline after installation, and prior to backfilling with natural materials, to ensure that the pipeline is stable during its operating life. Inside the cofferdam, there will be a 1 m deep gravel bed installed prior to pipeline installation.

Additional Considerations

Once the external asphalt, concrete coatings and internal epoxy coating have been applied, the individual pipe sections will be stocked at existing port facilities on the UK East Coast for shipment to the laybarges.

Cathodic protection controls metallic corrosion through the use of sacrificial anodes based on aluminium. The anode has the effect of making the structure a cathode, while the more reactive metal becomes the anode. Gradually the sacrificial anode is consumed, leaving the protected structure unaffected.

In total, approximately 4500 tonnes of the metals will be used along the route in equal portions. Anodes will typically be installed at every fifth joint where the pipeline is to be buried and every tenth joint for the remainder of the route. It is assumed that 10 percent of the anode will remain at the end of the operational life of the pipeline (50 years). This equates to a relatively small average annual loss of less than 140 Kg per kilometre.

Testing and Commissioning

Hyperbaric welding will be used for the mid-line tie-in and this necessitates the use of welding spheres, which need to be removed prior to pressure testing. The pipeline will be flushed prior to final commissioning using deoxygenated seawater to clear the two welding spheres from the tie-in point by driving them to Easington where they will be deposited in the pig-trap. It is estimated that approximately 120,000 m³ of seawater treated with an oxygen scavenger (sodium bisulphite at a concentration of 65 milligrams per litre (mg/l)) will be discharged at a planned rate of 1,600 m³/h through a dedicated discharge line. The discharge will be via the onshore receiving facilities, with specific details being contained in the Landfall ES.

After the welding spheres have been retrieved, the completed pipeline system will remain 'water filled' and will then be pressure tested to ensure its integrity. The pipeline will then be dewatered, dried, purged and gas filled.

The dewatering operation will be performed by driving a pig train from the Langeled Receiving Facilities at Easington to the Sleipner R platform. A temporary air compressor spread, including primary units and air dryers located in the Langeled Receiving Facilities will provide dry compressed air. A pig train that will consist of pigs interspaced with three batches of freshwater and air will be loaded and launched from Easington, and driven with compressed dry air to Sleipner. The discharge of chemically treated seawater will be at Sleipner in the Norwegian sector of the North Sea in accordance with a permit from the Norwegian Authorities.

Drying of the pipeline will be performed by continuously purging the pipeline with dry low-pressure air. The dry air will be injected at Easington using the same air compressor spread as used for dewatering, and vented to the atmosphere at the Sleipner R platform. The drying operation will be completed when the discharged air at the platform satisfies predefined acceptance criteria (dryness level). For safety reasons, the entire pipeline must be filled with inert gas (nitrogen) prior to the hydrocarbon gas being introduced. A nitrogen injection spread (nitrogen converter/pump, tanks etc.) will be located at Easington and nitrogen will be injected/purged through the pipeline and vented through the Sleipner R platform.

Gas filling will occur through gradually introducing dry natural gas into the pipeline at the Sleipner facilities. The nitrogen in the pipeline will be vented off through a temporary vent system at Easington, and the nitrogen/hydrocarbon gas interface through the permanent flare system. After the gas filling operation is completed, further gas will be introduced in order to pressurise the pipeline up to normal operating pressure.

3.2 Operation

Once operating under normal conditions no further engineering is expected to be required over its proposed lifetime of 50 years, except for the potential tie-in of additional pipes at the selected T-piece points (see Section 3.1.5) and possible work to reduce freespans. Periodic surveying of the pipeline will be undertaken to assess its condition and whether the spanning has occurred. If sizable spans occur then appropriate mitigation may be implemented such as covering the sediments with coarser gravels to prevent further erosion

3.3 Decommissioning

The co-operation agreement on cross-border pipelines between UK and Norway (see Section 1.1.1) specifies that decommissioning must be agreed between the regulators from each country. It is not certain what the regulations will require when the Langeled system reaches the end of its useful life, but the design process will ensure that all potential decommissioning options will be available to the pipeline owners.

3.4 Project Schedule

Pipelaying operations are planned throughout 2005. The installation sequence is considered as follows:

- Preparatory works at crossings - Commence February 2005
- Nearshore work (cofferdam installation) - March – April 2005
- Pipeline trench dredging (including floating channel and backfilling) - April – June 2005
- Laybarge LB 200 Start Pipelaying at Sleipner - April 2005
- Shallow Water Lay Barge Installation - May – June 2005
- Post-Lay Works and Tie-Ins - June 2005 - September 2005
- All Pipelaying Complete - October 2005
- Commence Operations - October 2006

4 LEGISLATIVE AND POLICY FRAMEWORK

The *marine pipeline* ES works will require planning approval under the *Offshore Petroleum Production and Pipe-Lines (Assessment of Environmental Effects) Regulations (1999)* ('The Regulations').

This Chapter outlines the planning legislation, guidance and policies that are relevant to the *marine pipeline* ES, including those related to the EIA. The Chapter also briefly outlines other pieces of legislation with which the *marine pipeline* ES must comply.

4.1 Legislation and Guidance Relevant to the Consent Application

The compliance requirements for an EIA derive from the EU Directive 85/337/EEC 'on the assessment of the effects of certain public and private projects on the environment,' as amended by the Directive 97/11/EC.

Implementation of the Regulations is overseen by the Department of Trade and Industry (DTI). They are advised by the Joint Nature Conservation Committee (JNCC), Fisheries Research Service (FRS), English Heritage (EH) and the Centre for Environment, Fisheries, Aquaculture and Science (CEFAS).

4.2 Compliance with Other Legislation

The Langeled *marine pipeline* ES works must also comply with other pieces of legislation. In some cases, permits will be required prior to undertaking specific site activities; in other cases, the relevant authorities will need to be consulted in order to satisfy themselves that the work methods or procedures proposed are fully compliant with the appropriate legislation.

The key legal instruments and their scope are briefly outlined in Table 4.1.

Table 4.1 Other Relevant Legislation

Legislation	Scope
The Petroleum Act 1998	This consolidated many of the regulations which apply to the offshore oil and gas industry and covers environmental and other issues. This also requires the submission of a Petroleum Operations Notice 16.
The Merchant Shipping (Prevention of Oil Pollution) Regulations, 1996. (Amendment Regulations 2004).	This places restrictions on the discharge to sea of oily water from machinery and non-hazardous drains. Following inspection, installations are issued with a UK Oil Pollution Prevention Certificate or equivalent International Oil Pollution Prevention Certificate, which confirm that the equipment meets the required standards.
The Food and Environment Protection Act, 1985	This prohibits the discharge of waste and the placing or depositing materials on or under the seabed, unless a licence has been issued. However, because of the nature of offshore operations, the regulatory authority introduced the Deposits in the Sea Exemptions Order, 1985, to exempt all non-oily discharges from the licensing requirements of this act.
The Merchant Shipping (Oil Pollution Preparedness Response and Co-operation Convention) Regulations, 1998 (Amended 2001)	This introduced specific requirements for oil spill contingency plans for mobile and fixed offshore installations and confirmed the requirements to report all oil spills.

Legislation	Scope
The Merchant Shipping (Prevention of Pollution by Garbage) Regulation, 1998.	This prohibited the overboard disposal of garbage. This introduced a number of requirements for waste disposal management offshore and requires the preparation of management plans.
Offshore Chemical Regulations, 2002.	This requires the operators of a proposed development to submit a relevant Petroleum Operations Notice (PON 15 C) to the DTI pertaining to the chemicals that are to be discharged into the receiving environment as part of a pipeline development.
Coastal Protection Act, 1949.	This requires consent for siting of offshore installations within UK Territorial Waters.
The Offshore Petroleum Activities (Conservation of Habitats) Regulations, 2001.	The above regulations call for Member States to identify Special Areas of Conservation (SAC). This is discussed in detail in Chapter 6 .

Source: UKOOA website¹⁵

4.3 Transboundary Environmental Impact

In 1991 at Espoo in Finland, the UN/ECE Convention of Environmental Impact Assessment in a Transboundary Context was established. The Espoo Convention addressed the need to enhance international co-operation in assessing transboundary environmental impacts and highlighted a number of activities that are likely to cause significant adverse transboundary impacts, among them offshore hydrocarbon production. The requirements of the Convention with respect to EIA's for pipelines on the UKCS are implemented through The Regulations.

Under Regulation 12 (3), where it appears to the Secretary of State (SoS) that the carrying out of a project would be likely to have a significant effect on the environment of an European Economic Associate (EEA) state (in this case Norway) or if Norway considers that its environment is likely to be significantly affected by the project, the SoS is required to forward to Norway the ES relating to that project at the same time as it is made available to the public in the UK.

¹⁵ 1 http://www.ukooa.co.uk/issues/1999report/enviro99_regulated.htm.

5 ENVIRONMENTAL IMPACT ASSESSMENT PROCESS

The purpose of an EIA is to provide a recognised and replicable process to identify the potential environmental effects of a proposed development. An ES is the document that contains the findings of the EIA to assist the regulator, in this case the DTI, in considering the likely effects on the environment and, hence, the decision on whether the development should be approved. The EIA process is broken into three stages; screening, scoping, and assessment.

5.1 Screening

The screening stage is used to assess whether an ES is required. The Regulations detail the structure and process that a developer must incorporate into an ES. The Langeled Project exceeds the thresholds defined by the DTI as it is greater than 40 km and has a diameter of more than 800 mm. An ES is therefore required.

5.2 Scoping

The Scoping stage reviews the existing environment, the potential development and assesses the potential impacts that may occur. It also considers alternatives. It then defines the extent of the final ES. The scoping assessment was undertaken in the first quarter of 2003, with a report issued to the DTI in March 2003 (Metoc Report MOCT67 OL1), highlighting the key areas of potential environmental concern. Consultations were undertaken at this time with statutory and non-statutory consultees reviewing and commenting on the document.

The scoping report was issued to all parties listed in Section 5.3 and the general conclusions of the report were accepted, with no objection to the overall project being raised, except in the instances where further clarification was required i.e. the need for additional survey work. Their comments have been included at all stages of the development process so as to minimise impacts where possible through either avoiding areas of potential concern or using alternative design engineering techniques.

The key areas of potential impact were identified as:

- benthic communities;
- coastal processes; and
- fisheries.

Furthermore, due to the nature of the project, it was concluded in the scoping report that the following areas were not considered significant:

- plankton; and
- seabirds¹⁶.

Consequently, the baseline determination and assessment of these areas is limited to the findings of the scoping report; with a brief summary provided in section 14.

¹⁶ “The pipe-laying process is a short term event, with no operational impacts on birds envisaged... During construction, impacts will be minimal, or non-existent, and comparable to normal shipping activity. For this project, although seasonal issues will be taken into account, it is considered that bird populations on the sea surface will not be significantly affected.” (MOCT67 OL1)

5.3 Consultation

Consultation with stakeholders has continued throughout the EIA process. Following circulation of the Scoping Report, there have been several exchanges of information with the DTI, their advisors and several interested parties. As a result, the project team has been able to develop the detailed design of the marine pipeline works to address issues raised by stakeholders during the consultation process.

The parties consulted during the preparation of the EIA were as follows.

- The Department of Trade and Industry (DTI).
- The Joint Nature Conservation Committee (JNCC).
- The Centre for Environment Fisheries and Aquicultural Science (CEFAS).
- The Fisheries Research Services (FRS).
- North East Sea Fisheries Committee (NESFC).
- National Federation of Fisheries Organisations (NFFO).
- Scottish Fishermen's Federation (SFF).
- English Heritage (EH).
- English Nature (EN).
- The Ministry of Defence (MoD).

5.4 Assessment of Environmental Impacts

This ES considers the potential affects of the construction, operation and decommissioning phases of the development, with particular emphasis on the key areas of concern identified in the scoping report. It considers the existing environment, potential impacts from the development, mitigation measures to alleviate these impacts, and any predicted residual impacts.

5.5 Impact Prediction

All developments create some disturbance to aspects of the environment, either because of physical impacts on natural systems, or due to interference with human activities and man-made systems. This ES seeks to establish the occurrence, and potential significance, of environmental impacts associated with the Langeled Project and if appropriate, to propose measures by which they might be avoided, reduced or remediated.

Criteria used for identifying the potential of impacts include the following:

- Is there compliance with UK laws or regulations?
- Is there compliance with international agreements which the UK Government might have entered into?
- Could any applicable environmental standards and guidelines be breached?
- Could any UK Government policies or plans be adversely affected?
- Will human environment conditions with regards to health, land-use or amenity be affected?
- Is there any long-term or permanent damage to ecological systems or natural assets of national, regional or local value?

5.6 Impact Significance

In developing criteria for assessing significance and in assessing the significance of impacts, a number of elements were considered:

- the magnitude of the change that could occur (e.g. the extent of habitat loss, the increase in noise levels);
- the nature of the resources or receptors that could be affected (e.g. the value and sensitivity of the habitat that could be lost, or the numbers and nature of the people who would be affected by an increase in noise);
- the existence of international, national, industry standards as appropriate;
- the views and perceptions of stakeholders;
- the need to reflect the likelihood that an impact may occur; and
- the need to ensure comparability between different types of impact so that, for example, a significant impact on an ecological resource is of comparable importance to a significant impact on an archaeological resource.

For some environmental aspects, for example noise and vibration, significance criteria were standard or numerically based. For other aspects, for which no applicable limits, standards or guideline values exist, a more qualitative approach was required. This involved assessing significance using professional judgement according to a combination of the value or sensitivity of the resource affected, and the magnitude of the impact on it.

5.7 Mitigation

The identification of mitigation measures in the design of the *Pipeline Landfall* ES was primarily achieved through the application of a 'hierarchy' in which:

- a primary objective is to avoid impacts, e.g. by adopting pipeline routing and construction methods to avoid the sensitive areas such as potential Annex I Habitats (pAIH);
- if avoidance is not possible, then impacts will be reduced at source;
- where avoidance or reduction at source can not be achieved, then the impact will be abated;
- where impacts are completely unavoidable, they will require remediation mechanisms; and
- residual impacts are those that will remain after the mitigation measures described in the ES are applied.

5.8 Report Structure

In the following sections in this ES sensitivities are treated separately and are structured in the following manner.

- Introduction
- Methodology
- Baseline Environment
- Assessment of Impacts

The statement concludes through summarising the assessment findings and stating the mitigation measures necessary to remediate these impacts. Where the impacts are unavoidable or remain post mitigation these are summarised as residual impacts. These mitigation measures form the schedule discussed in the final Chapter. This schedule comprises those measures the Project Team are committed to implement, but for which the precise detail may have yet to be finalised.

5.9 Interface with Other Project Elements

Within the UK and its territorial waters, the Langeled Project comprises three major elements:

- the marine pipeline (the subject of this ES);
- the pipeline landfall; and
- the receiving facilities.

Each of the above project elements is the subject of a separate EIA conducted by consultants specialising in that particular type of development. The associated ESs will be submitted to the appropriate authority when seeking authorisation for the project. There has been liaison between the consultants undertaking the assessment of the different elements of the Langeled Project to ensure consistency with respect to:

- the overall approach to the EIAs and, where appropriate; and
- terminology, prediction methodologies, and criteria for assessing significance.

6 PHYSICAL ENVIRONMENT

This section describes the physical environment along the pipeline route, in terms of oceanography, meteorology, bathymetry and geology. It considers the implications of the construction works and presence of the pipeline. It also discusses the potential effects on the coastal process involving the cliffs, foreshore, and wave cut platforms and their effect on the marine environment.

6.1 Methodology

Environmental consequences of meteorological and oceanographic ('metocean') conditions include sediment movement (during and after dredging of the trench) and the dispersion and eventual fate of discharges to the environment. Metocean conditions have been obtained from a number of available data sets including data from several key locations close to the development. Bathymetry has been taken from admiralty chart data in addition to localised survey measurements.

For the majority of the route (KP 23 – KP 521), the environmental assessment of the proposed activities for installation of the pipeline and the potential effects on the seabed geology and processes has been based on desk studies and the results from recent survey work.

The remainder of the route to MLW a comprehensive overview of the implications on the coastal and nearshore areas, specifically from near the Humber Estuary to the nearshore area was undertaken to provide an understanding of the coastal dynamics. This was agreed in consultations with English Nature (EN).

These data were then used to assess the impacts. Metocean conditions are important to determine the sediments dynamics along the pipeline route; It is possible to assess how the installation may impact the physical environment and through the use of previous studies it is possible to demonstrate the pattern of natural sediment movement. In relation to the proposed development it was essential to use these data to determine the potential impact of the project relative to natural processes.

If changes were predicated that would alter the baseline, this was deemed to be significant. Notably, the area over which sediment change occurred, coupled with the sediment type and the period of time for which the natural sediment processes would be altered were used to assess the significance.

6.2 Baseline Environment

6.2.1 Oceanography and Meteorology (Metocean)

Conditions at the sea surface change significantly along the route where more severe wind and wave regimes exist in open, deeper waters. However, these more severe conditions are less inclined to affect the seabed given the greater water depth. Therefore, where the water depth decreases significantly, at approximately KP 520 up to the MLW mark is the region where seabed forces are more dynamic leading to more sediment movement and natural disturbance.

Tidal currents have been examined at four locations along the route. Table 6.1 shows how seabed tidal current speeds increase, to a maximum of around 1 m/s, as the water depth becomes

shallower closer to the landfall. In the northern portion of the route, the tidal ellipse is broad and has a NNE-SSW orientation; in the shore approach the ellipse is rectilinear and parallel to the coastline.

Maximum current speeds are likely to occur when storm surge currents combine with tides. Storm surge currents alone have the potential of exceeding tidal current velocities and can persist for hours at a time. In the North Sea the long-term residual drift current is anti-clockwise around the basin bounded by the UK, Northern Europe and Norway. The velocities are low, especially in the central area, when compared with the tidal and storm surge currents presented above.

Table 6.1 Mean Spring Tidal Current Speed and Description of the Ellipse at the Seabed.

Location	Location	Water Depth (m)	MSTC at Seabed (m/s)	Orientation and Shape of the Tidal Ellipse
Near Claymore	58°25.9'N 001°45.3'E	109	0.21	022° / 202°. Broad
East Bank	55°28.0'N 001°00.0'E	81	0.28	020° / 200°. Broad
Cleeton	54°02.0'N 000°43.2'E	53	0.58	319° / 139°. Broad
14 km from Landfall	53°46.7'N 000°13.5'E	23	0.99	333° / 153°. Rectilinear

Shorewards from KP 520 seabed current speeds are critically important because of their impact on the dispersion and re-suspension of the dredged seabed sediment. Tidal currents at the seabed are generally stronger as the water becomes shallower. Surge currents are fairly uniform in this region, if depth-averaged, but at the seabed, they will increase as the water becomes shallower.

Table 6.1 shows mean spring tidal currents (MSTC) of 0.99 m/s in 23 m of water, 14 km from the landfall and 0.58 m/s in 53 m of water. At the seabed in 23 m and 53 m of water, the one year return storm surge current is around 0.47 m/s and 0.04 m/s respectively. The direction of this current is likely to be in a southeast direction. When combined with the southeast seabed MSTC, resultant flow could reach nearly 1.5 m/s 14 km from the landfall and 1 m/s in the deeper water at Cleeton KP 537.

Waves are generated by wind action on the surface of the sea and cause an orbital motion in the water column. The amount of motion that reaches the seabed reduces with water depth and increases with wave height. Surface waves are generally larger in the more exposed water along the route as demonstrated in Table 6.2. Despite this, the seabed effects of waves are more severe towards the south reflecting the influence of shallower waters.

Wave orbital motion affects and is affected by the seabed along the whole route. However, in the deeper water to the north, the effects only occur during storms. In the south, because the water is much shallower, waves influence the seabed more readily. Table 6.2 shows peak wave orbital velocity at the seabed associated with the one year maximum wave. Where the water depth is shallow (beyond approximately KP 520), even though the maximum wave height is only half the size of that in the north, seabed velocities are as much as seven times higher than in the deeper water to the north.

Table 6.2 Peak Wave Orbital Velocity at the Seabed Associated with the One-Year Maximum Wave at Four Locations

Location	1 Year Maximum Wave Height (m)	Spectral peak wave period Tp (s)	Water Depth (m)	Peak wave orbital speed at bed (m/s)
North End UK Route	19.9	14.2	137	0.54
Forties	18.9	13.9	104	0.92
222 km North of Bacton	14.5	12.1	35	2.57
16.7 km east of Easington	11.3	10.6	16	3.57

Nine miles east of Easington, where the water is 16 m deep, the seabed velocity associated with the one-year maximum wave is around 3.5 m/s. If the tidal current is in line with the waves and a storm surge component is present, instantaneous velocities at the seabed could reach 5 m/s.

Winds are generally less severe closer to the coast as the landmass alters the wind regime. The wind regime of the North Sea is characterised by frontal depressions and anti-cyclones (high pressure). Frontal depressions generally move from the southwest, bringing wind and rain, and are much more frequent in the winter months. Anti-cyclones are often a summer feature and are associated with periods of lighter winds from the west and northwest.

Figures 6.1 and 6.2 show pairs of wind roses taken from data close to the pipeline route. In January the prevailing wind is south-westerly, typically in the range 5 to 15 m/s close to the UK shoreline and a little more severe across open waters. In July, the wind speeds are generally lower, mostly below 10 m/s, with directions often being westerly and north-westerly because of the effects of the high pressure systems over the UK.

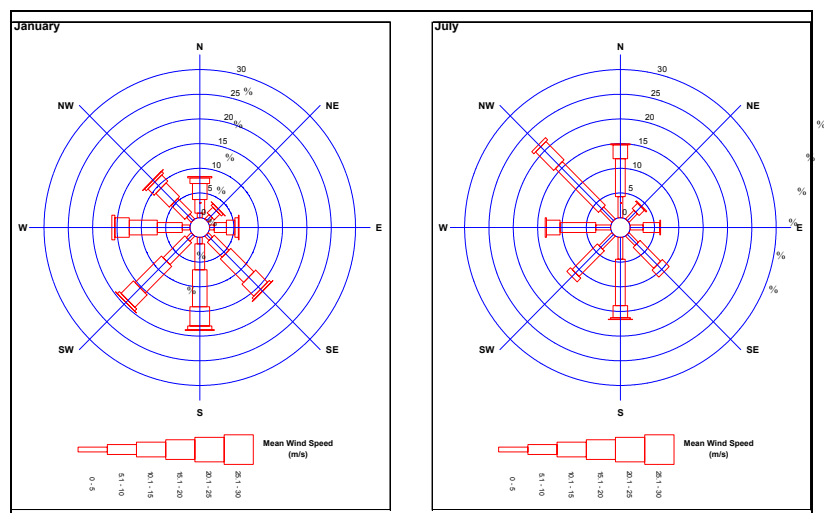

Produced from NEXT wave model data grid point 58°36'N 1°27'E [ref 91]

Figure 6.1 Wind Roses showing Open Water

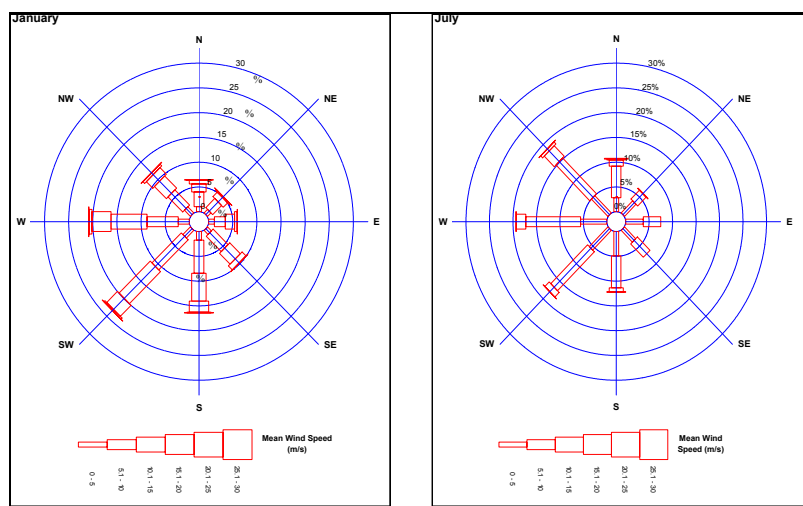

Produced from NEXT wave model data grid point 54°55'N 1°24'E [ref 91]

Figure 6.2 Wind Roses relatively close to the UK Coastline

The mobility and movement of sediments is driven by wind, wave and current interaction. Any movement is heightened by stronger tidal currents, but it is the wind that determines its direction of movement.

Bathymetry. From the UK/Norway Median Line southwards the route largely crosses a sub-sea plain that slopes very gently northwards, to approximately KP 30. The seabed along, and in, the immediate vicinity of the pipeline route is; therefore, of relatively subdued relief, except for a number of localised, steep-sided, glacial features. Beyond this to approximately KP 161 (57°N) water depths decrease slowly from a maximum of 100 m. Between KP 161 (57°N) and KP 276 (56°N) the water depth then increases again to around 90 m. However, in this area the route passes between two of the glacially formed Devil's Hole group of linear deeps, where the depths are more than 120 m on the eastern side and more than 130 m on the western side of the pipeline route. Between KP 276 (56°N) and KP 389 (55°N) the depth gradually decreases from 79 m to 58 m, along which the route passes to the west of a small glacially-formed deep at KP 361, where depths rapidly increase to 88 m. The route then continues to decrease to 53 m at KP 486.

Water depths shoreward of KP 517 (the 12 nm UK Territorial Limit) are; therefore, more severely affected by metocean conditions as discussed above. The water depth here is approximately 35 m. The shoreline platforms are subject to particularly rapid erosive activity. The offshore platform is subject to moderate erosion, leaving a gentle easterly sloping seabed, which continues to 22 m to 23 m (KP 521 – KP 525) water depth. At this point, there is a further change of slope and a steepening of the seabed's easterly facing slope. It is possible that this change of slope marks the point where, some 10,000 years ago, rising sealevels began to erode the Holderness coastal cliffs. Inshore of this, the 15 – 16 km of offshore seabed that has been inundated by the sea as a result, would have required a cliff erosion rate of approximately 1.5 – 1.6 m/annum in order to be formed. This is a rate very similar to that of today's average Holderness coastal. The nearshore platform is a shallow, sloping area to approximately minus 9.5 m - 12.0 m, extending to approximately 1 to 1.3 km offshore (KP 542). The bathymetry is shown in Figure 6.3.

6.2.2 *Geology*

The basin of the North Sea has been affected by developing ice sheets on several occasions over the last 1.6 million years [ref 57]. From about 800,000 Before Present it is suggested that a possible seven periods when intense cold have occurred that have affected the North Sea area, either with or without an ice incursion. The most extensive was during the Anglian period, some 400,000 years ago, when even the Southern North Sea was largely covered by an ice-sheet [ref 44].

These events have created the seabed of today, which comprises a drowned pre-Holocene (>10,000 years) glaciated land surface. This most recent incursion of ice almost reached the position of the North Norfolk coast before beginning to retreat some 17,500 years Before Present. It left behind debris that was reworked, first by rejuvenated rivers and then by the advancing, transgressive sea. These processes have led to the substantial modifications to the above pre-Holocene surface, leading to erosion in some places and deposition in others.

Along the pipeline route, the environment reverted to a marine environment approximately 12,000 before present and, although the most rapid rise of sea level ended about 5000 years Before Present, the sea level continues to rise and the seabed is being continually modified by metocean conditions, whilst the coastline continues to erode and retreat. In addition, the northern parts of the North Sea Basin are rising due to global melting of ice, while the southern parts are sinking as deep-seated crustal movements adjust to the unloading effect in the north [ref 74].

The baseline environment is defined in three sectors:

- the first is the more open deeper waters from the UK/Norway Median Line working southwards (discussed more generally in terms of four substrate categories: soft substrates; intermediate substrates; hard substrates; and mobile substrates);
- the second, where there is a significant change in bathymetry at approximately KP 521 marking the possible point where the coastal cliffs formed by the last ice-age started to be eroded as a result of sea-level rise; and
- the third, from KP 538 (12 m) to the MLW mark, where rapid erosion of the present cliff has occurred.

The various regions and areas discussed are shown in Figure 6.3.

Geology from KP 23 – KP 521 (Northern and Central North Sea)

Soft substrates comprise fine sediments (< 0.125 mm) with a high silt, or even clay, fraction are generally found in the deeper parts of the Basin and in hollows, such as the glacially eroded deeps of the Devil's Hole; but, can also be found in more open, deep-water areas. These 'MUDS' are created slowly on a large-scale by the action of advected suspension currents moving in from the NNS.

Where encountered as seabed sediment they are usually in areas where sediment mobility is low-to-very low (see Table 6.1) and deposition is the active process. These very fine materials often become lodged within the interstices of sands. The resulting 'muddy SANDS' are most

commonly found north of KP 200 (56° 40' N). The deposits are generally less than 0.5 m in thickness, but locally, can be as thick as 5 m.

Underlying the thin surface sediments north of KP 389 (55°N) are other potentially soft sediments, deposited under glaciolacustrine conditions¹⁷. These deposits are the Botney Cut Formation and its northerly equivalent, the Forth Formation. They can be very-soft-to-soft-occasionally-firm, grey, sandy and gravelly MUDS and usually completely infill a linear system of sub-glacial valleys.

Intermediate substrates. Along much of the route the unlithified (loose) material is very-fine-to-fine-or-medium SAND, with only occasional patches of gravelly-SAND, especially north of KP 389 (55°N). Generally, this deposit is less than 0.5 m in thickness, although this can be exceeded locally. In that part of the route between approximately KP 444 (54° 40' N) and KP 522 (53° 50') thicker, potentially mobile, sands are to be found. Elsewhere signs of mobility of these deposits are in the form of the occasional sand ribbon or sand streak, aligned along the dominant tidal stream directions. Mobility will only occur under the strongest tidal action aided usually by wave and surge current activity (see Tables 6.1 and 6.2).

¹⁷ Pertaining to, derived from, or deposited in glacial lakes.

Figure 6.3
Bathymetry of the
Study Area & Notable
Physical Features

This product has been derived, in part, from Admiralty charts and publications with the permission of the UK Hydrographic Office and the Controller of Her Majesty's Stationery Office under Licence No. HO 552/020121/05. All rights reserved. (Not to be used for Navigation).

Projection UTM 31N
 Datum WGS84
 Spheroid WGS84
 File Reference P517-Final Report
 Bathymetry & Physical Features.srf
 Date 12 March 2004



Bathymetry of the Study Area

Water Depth (m)

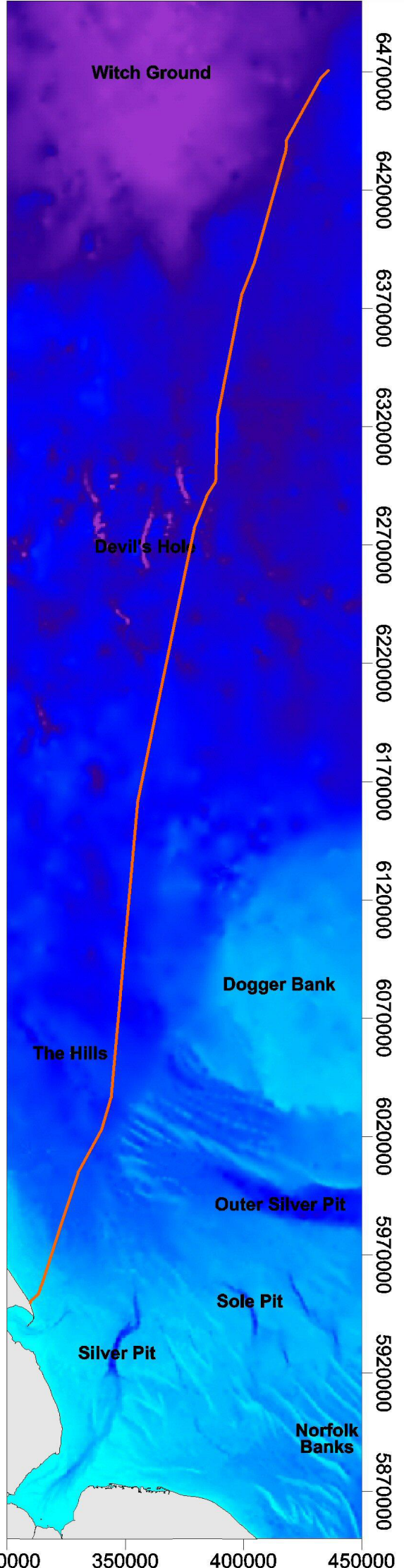
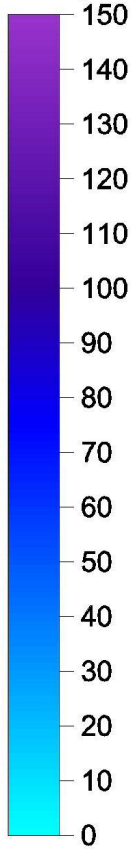

Detail of Shore Landings

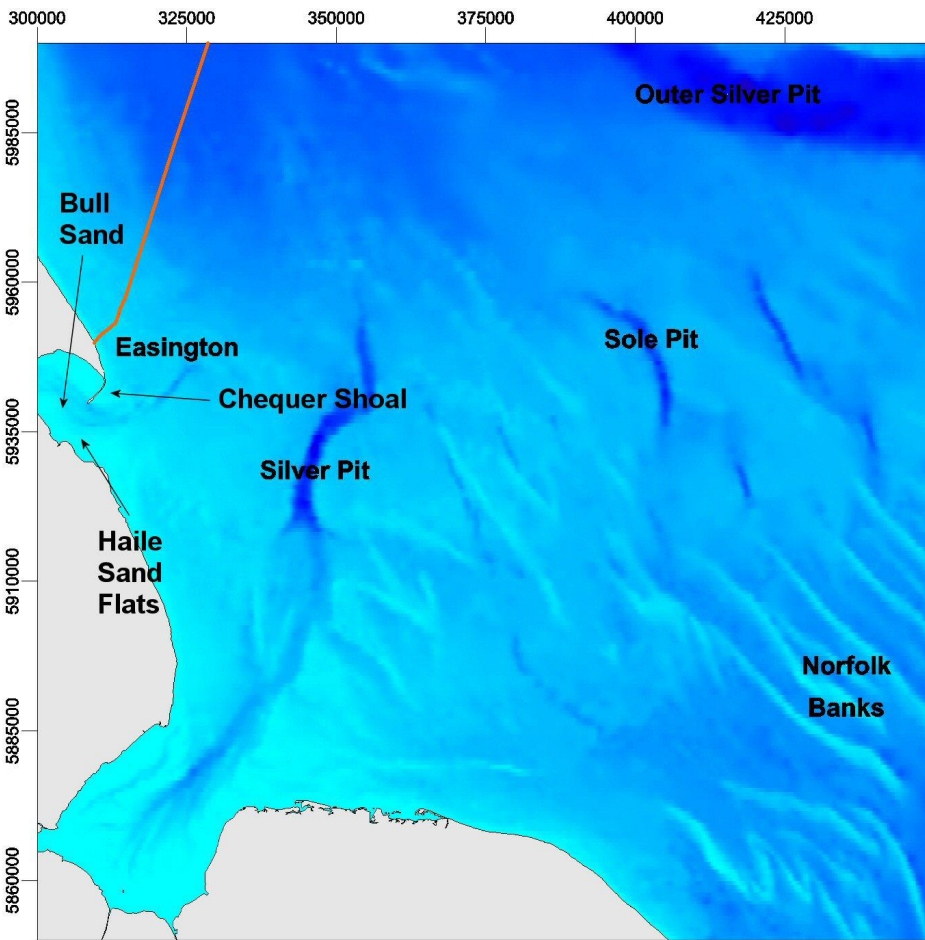

300000 350000 400000 450000

- *Unconsolidated coarser sediments* are usually found south of approximately KP 464 (54° 20'N), and comprise coarser grain size materials, such as gravels (> 2 mm), pebbles (> 4 mm), cobbles (> 64 mm) and boulders (> 256 mm). As shown in Tables 6.1 and 6.2, instantaneous velocities of 5 m/s can be achieved. These extremes are capable of moving materials up to 10 mm in diameter; therefore, transport away any finer grade sediment either present at the surface or associated with the underlying Bolders Bank Formation as it becomes exposed. Thickness of these remaining sediments varies but is usually less than 0.5 m.
- *Hard, cohesive deposits* can form when sediments become buried and their water content removed through overlying sediments compressing the material. In the North Sea, this cohesion process has also taken place, due to the burial of finer grained sediments or clay-rich Till (boulder clay) under the weight of an ice-sheet.

A similar process can occur in comparable sediments when they remain, or become exposed, and subsequently dry-out under periglacial conditions¹⁸. The resulting sediments vary resulting in soil descriptions of firm (60 kPa) through to stiff, very-stiff, hard-to-very-hard (400 kPa). The route crosses a variety of these relatively cohesive deposits. Northwards along the route, where overlying deposits are thin or absent, they might be encountered and include the following formations.

- Bolders Bank Formation. A brown-to-red glacial Till comprising a firm-to-stiff, sometimes very-stiff or hard, sometimes sandy-or-silty CLAY with up to 10 % gravel-to-boulder clasts of chalk, mudstone, sandstone with igneous and metamorphic rocks. The latter tends to be the cobble and boulder clasts. This deposit is found from the shoreline at Easington as far north as approximately KP 389 (55°N).
- Yarmouth Roads Formation. Compact sands and stiff-to-very-stiff, dark grey CLAYS. These occur north of KP 389 (55°N). Geologically similar formations are found along the route: the Coal Pit Formation north of KP 276 (56°N) and the Fisher Formation becoming increasingly associated with the Coal Pit Formation north of KP 161 (57°N).

Where these formations are found within 5 m of the surface they present a potential problem where the anchors are deployed in these sediments as discussed later in this document. These areas are found in the following locations and are shown in Figure 6.4.

Table 6.3 Locations of Hard Cohesive Deposits found within the upper 5 m of the Seabed Sediment Profile

KP Points	KP Points	KP Points
36-40	45-104	124-190
230-253	267-272	310-313
318-320	425-543	

- *Bedrock* can be defined as rock strata that have undergone a cementation process that binds the constituent fragments into a hard mass that can generally resist erosion. Along

the route the bedrock either outcrops (i.e. comes to the surface) or is only covered by a very thin layer of sediments (< 0.5 m) in an area particularly to the west and northwest of the Sand Hills area (approximately west of 0° 40' E and between 54° 50'N and 54° 05' at KP's 407-494 relative to the pipeline). Here the bedrock is particularly hard comprising siltstone, sandstone and limestone of the Jurassic age [ref 12]. The outcrops sometimes occur in rock ridges standing several metres above the surrounding seafloor. The route into Easington has been aligned so that it passes immediately to the east of this bedrock area; thus, avoiding the difficulties of trenching and laying that would have resulted if the most direct route had been followed.

Mobile substrates comprise the loose sediment of sand-sized material (63 µm to 2 mm) usually < 3 m in thickness. These materials cover a large area of the route. While this substrate is rarely mobilised in water depths beyond KP 501 (50 m), in water depths less than this, the metocean conditions discussed in Tables 6.1 and 6.2 can induce substantial quantities of sand to be moved. It is within the shallower areas where sediment mobility is at its greatest. These areas comprise sandwaves (> 1 m, trough-to-crest height) and mega-ripples (< 1 m, trough-to-crest height) in addition to thin, but extensive, sand-sheets. These bed-forms are prolific in the Sand Hills region (see Figure 7.4), southwest of the Dogger Bank, approximately between KP 456 and 496. The more sensitive sandbanks (see section 7) are to the east and well away from the pipeline route, which is located within areas of sandwaves, mega-ripples and thin sand-sheets.

To the north along the proposed route, where it passes to the west of the Sand Hills region (see Figure 6.3), there is a large sandwave field, approximately between KP 456 and 496. Here there are some 140 to 150 sandwaves. Within this region, particularly KP 504 to KP 523 (54° and 53° 50') north, under more severe conditions, a carpet of sand is likely to be swept over what are generally fixed features. The result is a localised adjustment in height and position of parts of each sandwave. South of the West Sand Hills sandwave field (KP 495) the pipeline is located in mega-ripples or rippled sand sheets.





Geology from KP 521 – KP 542 (Offshore Platform)

Offshore, the wave-cut platform of Basement Till, termed by BGS [ref 13] the 'Bolders Bank Formation', was formed originally by cliff erosion (see Figure 6.4). Patches of sand found on the more rapidly eroding nearshore platform migrate seaward onto this offshore platform sometimes forming in both areas as mega-ripples¹⁹. Once formed they travel predominantly southward; however, this movement can be temporarily reversed where prolonged and powerful southerly and south-easterly wind/wave action periods occur. In deeper water, usually below 15 to 18 m, the ripples (sandwaves) formed on the sand patches can be larger (up to 3 or 4 m trough to crest height). Thin streaks and ribbons of sand are also found at these depths.

¹⁹ Defined as having a crest to trough height <1 metre.

Figure 6.4
Hard Cohesive Deposits Located
within 5m of Seabed Surface

Legend

-  Bathymetric features
-  Transboundary line
-  Southern pipeline system
-  Land
-  Sensitive anchor mound areas

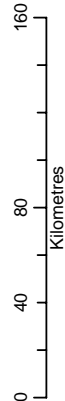

© Metoc plc, Data Licence 052003.005. All Rights Reserved.
NOT TO BE USED FOR NAVIGATION

Project Manager	Philip Wernyss
GIS Specialist	Jillian Barnes
Date	26 April 2004
Projection	UTM Zone 31N
Spheroid	International 1924
Datum	ED 50
Data Source	Metoc Charts, Statoil-Norsk Hydro
File Reference	\\/. P517/GIS/AvProj/P517-anchor mound areas.mxd

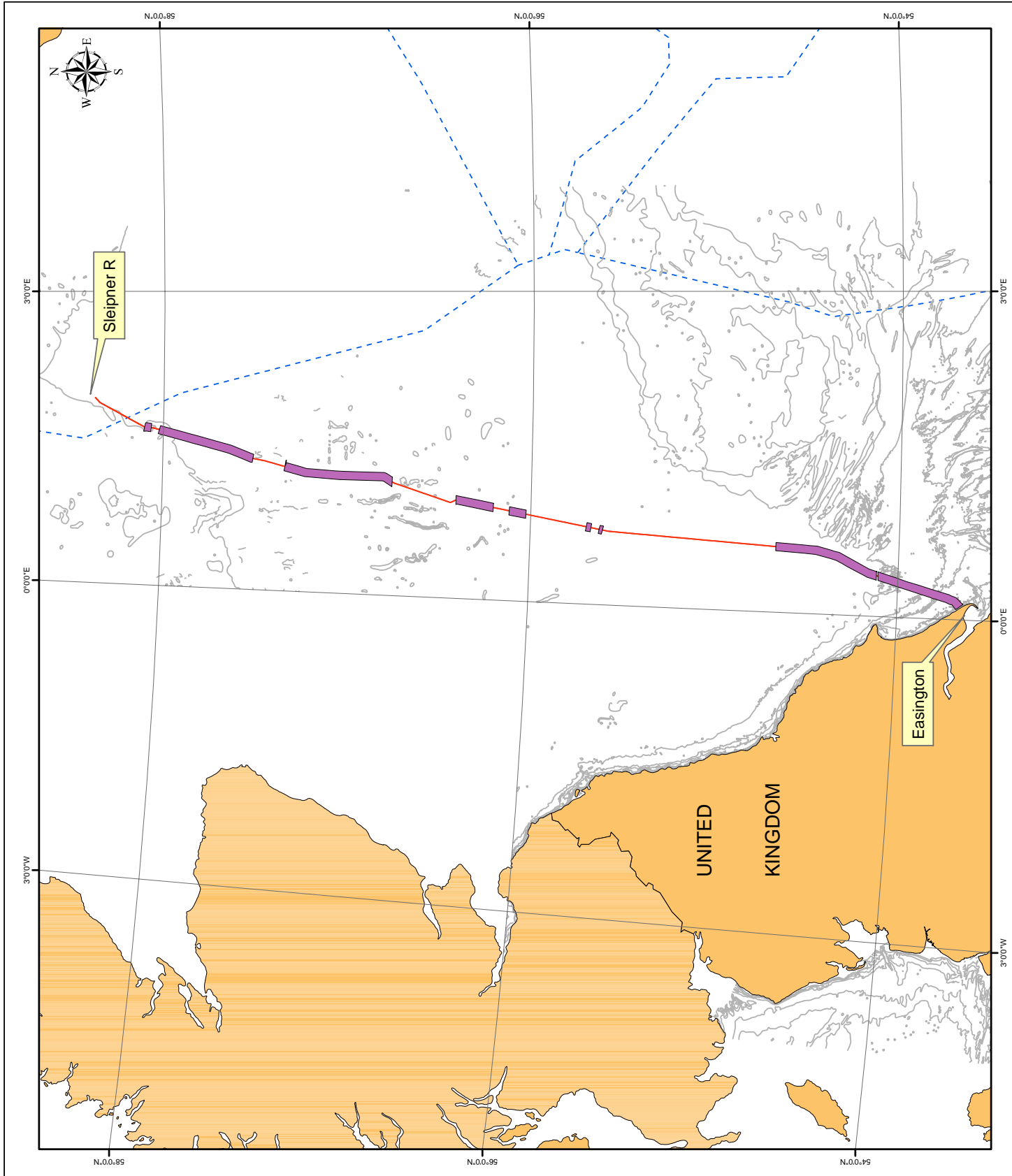

Elsewhere on the offshore platform, spreads of pebbles, cobbles and boulders are found, sometimes swept into localised reef forms by wave action. Some layers within the Till are more over-consolidated than others and are less readily eroded. These remain elevated above the general seabed surface (*Statoil/Easington Nearshore Bathymetric Survey, 2003*). Such ridges are found extensively between KP 536 to KP 538.

Geology from KP 542 – KP 543 (Nearshore Platform)

The Holderness coast extends 80 km between the chalk cliffs of Flamborough Head in the north to the shingle spit of Spurn Head at the mouth of the Humber in the south (see Figure 6.4). The continuous erosion of the coastal cliffs and nearshore platform down to approximately 12 m, and the subsequent separation and sorting of sediments, chiefly by wave action and provides most of the beach material. Importantly, this also provides the material for the maintenance of Spurn Head by the action of long-shore drift. Spurn Head, in turn, provides the protection for the continued maintenance of the local coastal designated sites (SSSI, SPA, Ramsar) including the Lagoons, the Humber Flats and Marshes.

6.2.3 Sediment Transport Process

The average cliff erosion rate close to the landfall has been measured at 1.74 m/annum [ref 113]. Over individual stretches the rate varied between c.0.36 and 2.75 m/annum. Recent records by East Riding of Yorkshire County Council show similar average rates of approximately c.1.80 m/annum. Along this coast, the retreat of the cliff is sufficient to produce a total average sediment yield of c.1.20 million m³/annum [ref 2] whilst that derived from erosion of the nearshore platform is almost double at c.2.20 million m³/annum [ref 2] providing at average total of c.3.15 million m³/annum [ref 2]. However, the transport paths and the ultimate destinations of these materials differ depending on the particle size of the eroded material.

Fine sediment includes the clay and silt fractions of the mobile eroded materials. From analyses of the core materials taken during the project geotechnical survey [ref 42], this represents approximately 75% of the average estimated total eroded sediments, or 2.55 million m³/annum derived from the cliff, the inter-tidal area and nearshore platform. This fraction migrates towards the area immediately offshore of the Humber Estuary as suspended or semi-suspended load (Southern North Sea Sediment Transport Study (SNSSTS) of 2002). The part of this load that remains within the nearshore platform area will move into the Humber Estuary along the flood-dominated channels on the north side of the Binks, and to the south of the Chequer Shoal and Bull Sand (SNSSTS of 2002). Here some of it will be deposited on the inter-tidal flats and marsh areas of the Humber Estuary. It is estimated that this could amount to approximately 100,000 m³/annum [ref 80] but more recent estimations put this quantity at 850,000 m³/annum [ref 10].

Much of the remaining suspended material accumulates within the channels and dock areas of the Humber Estuary where over 3 million m³ has been dredged in recent years. It is estimated that c.2.22 million m³ of sediment per annum, both fine and coarse, is transported into this area from the sea, in addition to c.300,000 m³/annum from the River Humber [ref 95]. From a magnetic characterisation dataset, a sediment budget for the Humber Estuary shows that the modern estuary sediments predominantly comprise fine and coarse materials (98%), derived from Holderness coastal glacial tills.

However, part of the suspended load, especially that element that has either been generated from eastwards of the offshore platform or has moved offshore and is transport south along the coast and moves south-eastward and then eastward as it becomes part of the East Anglian/Humber plume. This plume finally deposits in the Oyster Grounds area or even further east within the German Bight [ref 32].

Course Sediment includes the sand, gravel, cobble and boulder fraction of the eroded material from the cliffs transported onto the *nearshore platform* and from *nearshore platform* itself. This represents the remaining 25% of the total eroded sediments or c.850,000 m³/annum. This material is dominated by sand fractions. As with fine sediments, the net movement is southwards driven largely by wave action but also aided offshore by tidal action (SNSSTS of 2002). As the proposed landfall is almost at the southern end of this transport system, practically all of this volume of material passes the landfall either on the beach or offshore. Of the coarser sediments, the sand and gravel fractions are the most easily moved and recent work (SNSSTS of 2002) has proved that these fractions firstly help maintain Spurn Head and the Binks, and secondly, once at the mouth of the Humber much of it moves westward and southward across the estuary as sand ribbons and patches. Here it is incorporated in the fringing sand flats of the estuary, which leads to substantial accretion²⁰ on the Haile Sand Flats at the Humber approaches off North East Lincolnshire. There is also a small fraction that moves further south past Mablethorpe in Lincolnshire towards the Wash in East Anglia.

6.3 Assessment of Impacts

The estimated volumes of sediments to be reworked over the whole pipeline route are shown in Table 3.1 and are discussed in detail below.

6.3.1 Northern and Central North Sea (KP 23 – KP 521)

Where the pipeline is routed across *soft substrates*, turbulent current flows, induced by the laying operation and by the pipeline after it is installed, could cause local erosion effects. These effects will only occur in the areas where these soft deposits are found (approximately KP 30 to KP 361) and given the water depth in this region 75-100 m, effects will be generally slight. During extreme conditions, where effects of tidal currents, wind/wave activity and surge currents are combined, there may be a limited localised impact that is short-term (see Tables 6.1 and 6.2).

For *intermediate substrates*, the pipe-laying activities will disturb a generally thin layer of fine-to-medium sands and expose the older, usually harder substrates that lie beneath. In these regions minor localised erosion is likely.

Where *hard substrates* occur, largely immobile *unconsolidated coarser sediments* will act as a stabilising element for the pipeline where it lies directly on the seabed. Where post-lay trenching/pre-lay sweeping will be carried out (between KP 486 to KP 521, (53 m to 22 m water depth) exposing the Bolders Bank Formation) the surface spoil will be eroded by tides and waves and will release more stabilising coarse material (some 10% by volume) adjacent to the pipeline. *Hard cohesive deposits* will largely resist erosion because of their stiffness and the very low tidal current and wave orbital speeds at their deepwater locations (see Tables 6.1 and

²⁰ Over a five-year period (1991-1996) this has been measured as a 2.4 % increase (Leggett *et al.*, 1998)

6.2). However, where they are brought to the seabed surface and exposed due to activities like dredging, trenching and anchoring they may potentially impact on the baseline environment.

With *mobile substrates* spans may appear and disappear over a cycle of perhaps two-to-three years as the sediments are gently moved by metocean conditions. This resulting effect could lead to localised exposure of the pipeline or create spans between high points on the seabed.

6.3.2 Offshore Platform (KP 521 – KP 538)

Within the area of the offshore platform it is anticipated that c.42,000 m³/km²¹ of dredge material will be disturbed through construction in this region. This material will be transported across the offshore platform in a patchy and spasmodic manner taking the form of sand patches and sand ribbons. There are a few larger patches of sand containing sandwaves found shorewards of KP 526 (18 m). These are believed to move only a little, even under the severest of metocean conditions (SNSSTS of 2002). Given that the offshore platform is largely covered by a thin layer of immobile gravels, pebbles and cobbles, shoreward of KP 521 pre-dredging/post-lay trenching will result in only a small loss of sediments. This is due to being carried out at the same time as the pipelaying with the displaced spoil will be replaced immediately.

Only the finer fractions will be dispersed as suspension load. These will follow the same transportation routes discussed in Section 6.3.3; however, it is likely that a majority of this material, at this distance offshore, will become part of the eastward moving East Anglian Plume, and will be moved as streaks, ribbons and small patches by strong tidal currents and wave action. The coarsest fractions (gravel-to-boulders) are expected to remain close to the trench.

The installation of the Langeled Pipeline over the existing pipeline will create a 3 m high structure off the seabed. As shown in the *nearshore bathymetric survey*, many ridges of accumulated cobbles and boulders, or upstanding ridges and knolls of more resistant Basement Till (part of the Bolders Bank Formation) already exist in the area. Some of these ridges and knolls are more sizable than the profiled crossing point (up to 5 m high) and extend over 300 m². Furthermore, these features do not appear, from the survey, to be impeding southerly sediment movement in the area and it is concluded that the metocean conditions will be sufficient to move sand around an obstruction of this size.

6.3.3 Nearshore Platform (KP 538 – KP 543)

Within the area of the *nearshore platform* it is anticipated that c.195,500 m³ ⁽²²⁾ of materials will be removed through the wider dredged channel, floating channel and cofferdam²³. Of this material approximately 90 % comprises Basement Till (c.175,500 m³) overlain by a thin deposit of mobile sands and gravels, which become thicker towards the MLW mark (c.20,000 m³), the excavated materials will be removed from the seabed and temporally placed to one side (south) of the channel. The excavation methods in combination with the metocean conditions could

²¹ See Table 3.1.

²² This does not include the remaining sediment excavated in cofferdam, which is covered in the *landfall pipeline* ES.

²³ This is based on the following dimensions: floating channel 158 m at its widest, 550 m long and an average depth of 3 m; coffer dam 5 m wide, 90 m long and 5 m wide; and the wider dredged channel approximately 10 m wide, 985 m long and 2 m deep on average.

result in up to a 30% loss in the sediment transport process, namely c.39,500 m³ ⁽²⁴⁾. These volumes are relatively small when compared with natural releases discussed in Section 6.2.2. It is; therefore, concluded that the removed materials will not have any significant adverse effects on the area and could even be considered marginally beneficial in maintaining the various sensitive features in the adjacent areas. The volume of coarser material required for backfilling will be approximately 90% of the total released originally during the intervention works or c.175,500 m³. Consequently, there could be insufficient material to backfill the region to its original level if severe weather conditions were encountered. However, taking into account the increased voidage (specifically, the returned materials will be less compact than when removed) and the short duration of this operation this loss would be minimised.

The downstream sediment supply that protects the seaward side of the ‘Lagoons’, south of Easington, and maintains Spurn Spit and Spurn Head are dependent upon a supply of sand and shingle for their continued maintenance. The sand dunes provide a frontage that protects the lagoons from inundation by the sea. Prior to sea defences, erected in the nineteenth century, the spit comprised a series of islets with the tide running between them during high tides and storm periods. More defences, erected during the twentieth century, have increased the stability of the spit. However, some of the sands supplying the spit migrate off Spurn Head and move onto the sandbanks in the mouth of the Humber and the fringing sand flats on the Yorkshire and Lincolnshire coasts (SNSSTS, 2002). Even if natural movement of sediment was relied on solely for backfilling the trench, only a very small amount (c.26,500 m³ ⁽²⁵⁾) of the large volume (c.850,000 m³) of the naturally intermittent supply of coarser sediment that progresses down the coast would be involved (3.1%). The natural supply of material is dependent upon the frequency, direction and strength of northerly and easterly gales and their timing relative to tidal height. It is not considered that this small reduction of quantity over one year will adversely affect the stability of either the Lagoons or the Spit that rely on a natural supply of sand and shingle.

The cofferdam will lie at an angle of 62° to the coastline on its northern side. This will assist in retaining any mobile bedload sediment that move south along the beach and nearshore platform during the construction period. This sediment will be held up on its transport path for a short time before being released after construction is complete. The amount of ‘natural’ sediment coming in from the north will be relatively low during this spring/summer period, when peak construction activity is planned. Some of the sediment might spill around the seaward end of the cofferdam into the pipe trench but the cutter suction dredger will move any initial material to the south.

Regarding pipeline burial, it has been estimated that the surface area of nearshore platform is eroded downwards at an average rate of 20 mm/annum [ref 2]. Over the 50-year operational life of the pipeline the average vertical erosion of the overlying Bolders Bank Formation surface is predicted to be approximately 1 m on average. The pipeline will be buried to a minimum depth of 3 m to the top of the pipeline depending on the water depth, which takes into full account the expected vertical erosion rate over the pipeline’s lifetime; therefore, it should remain buried over its lifetime.

²⁴ Three quarters of the material is Till (75%), therefore, 75% x 175,000 m³ = 131,500 m³. Then 30 % of this amount = 39,500 m³. Value rounded to the nearest 500 m³ of material.

²⁵ Of the Basement Till the coarser bedload comprises 15 % of 175,500 = 26,500 m³

6.3.4 Other effects

Intervention Works

The removal, reworking and deposition of excavate material on the seabed in a disaggregated (mixed up) manner will have an effect on the geology. The metocean conditions in the area will unavoidably lead to some erosion; however, the predicted volumes are not significant. The disaggregation of the profile will; however, result in the possibility of placing different materials, including boulders and cobbles, on the seabed leading to the potential loss or alteration in community structure as discussed in the following Sections.

Anchoring

The use of anchors may result in the creation of anchor mounds or scars, the scale and severity of which will vary along the route, depending on sediment type and depth. It is possible that an area of 40 m² may be affected by each anchor drop. After construction, the duration over which the anchors scar/mounds remain depends on the sedimentology of the region. Where anchoring will occur in unconsolidated coarser sediments and mobile substrates these mounds and scars will be quickly reworked and the area will be reinstated within the short-to-medium term. In other areas, where the scars/mounds are more prominent, the finer sediments will be washed away from the mounds leaving the harder and/or coarser sediments. This is especially true of clay areas (see Figure 6.4).

7 CONSERVATION AREAS

The *Offshore Petroleum Activities (Conservation of Habitats) Regulations 2001* enact both the *EU Habitats Directive 92/43/EEC* (as amended by 97/62/EC) on the ‘*Conservation of Natural Habitats and of Wild Fauna and Flora*’, known as the “*Habitats Directive*”, in addition to the EU Directive on the ‘*Conservation of Wild Birds*’ (79/409/EEC): the “*Wild Birds Directive*”. These regulations call for Member States to identify Special Areas of Conservation (SAC) within their territorial waters. The implications of this programme area discussed in this Chapter.

7.1 Methodology

Information on conservation areas close to the development was obtained from a number of secondary sources which include; EN, the JNCC [ref 69], and the DTI [refs 26 and 27].

Information regarding the presence of habitats and species of conservation importance were initially identified from secondary data sources including; the BGS record [ref 13], geophysical surveys, The Juno project off the Easington coast, UK Benthos database, previous biological surveys [refs 60 and 61], and Region 6 of the Coasts and Seas of the UK [ref 3]. This work was then followed-up with primary survey work in areas of interest using Remotely Operated Vehicle (ROV) and photographic techniques (undertaken in March 2004) examining areas of gravelly sand in water depths of less than 60 m, from KP 486 to KP 534. Information on pockmarks was taken from the SEA 2 Technical Report [ref 69] and complemented through a survey undertaken by Statoil [ref 59]. The sensitivity data of *Sabellaria spinulosa* in the North Sea were provided from the Marine Life Information Network (MarLIN) website [refs 55 and 64].

An assessment of impact significance based on the magnitude and permanency of loss or damage to potential Annex I Habitat areas culminated in the following definitions.

Significant Permanent damage or loss to the structure/integrity of the total habitat and/or associated species resulting in its failure to qualify as a potential Annex I Habitat under EU definitions. Given the sensitivity of pAIH habitats this definition extends to the damage or loss to the structure/integrity of a sufficient proportion of the habitat (either directly or indirectly) that its classification as a pAIH is compromised for greater than one year.

**Negligible/
No Impact** No measurable direct or indirect impacts that would comprise the integrity of the pAIH achieved through actively avoiding the areas during route selection.

7.2 Baseline

7.2.1 Offshore Areas of Conservation Interest

Advisory bodies, such as the JNCC, are currently identifying areas that could be put forward to the government for protection as Special Areas of Conservation (SACs) as part of the *Natura 2000 in UK Offshore Waters* process [ref 68]. These areas are currently being defined as potential Annex I Habitats (pAIHs) after those habitats listed in the Directive. To date, there are no designated offshore SACs in UK waters. There are numerous additional potential Annex I

habitats listed in the Habitats Directive to those mentioned below. However, none are known to occur in offshore UK waters²⁶. Further detail, including sub-classifications of each habitat by its sediment type, is provided by the JNCC²⁷. The following habitats are discussed in more detail below; sandbanks, pockmarks and reefs.

Sandbanks

Sandbanks/sandwaves slightly covered by seawater at all times are described as “sublittoral sandbanks, permanently submerged. Water depth is seldom more than 20 m below chart datum. Non-vegetated sandbanks or sandbanks with vegetation belonging to the *Zosteretum marinae* and *Cymbodoceion nodosae*²⁸” (EC, 1999)

The pipeline passes through an area of sandwaves, between KP 456 and 496 (see Section 6.2.2). However, the sandwaves lie in water depths much greater than 20m and are not part of a major named sandwave field or sandbank area. As such this particular area of sandwaves is not anticipated to be an important habitat feature..

Pockmarks

Natural submarine structures formed by leaking gas are “submarine complex structures, comprising rocks, pavements and pillars up to 4 m high. These formations are due to the aggregation of sandstone by carbonate cement resulting from microbial oxidation of gas emissions, mainly methane. The methane most likely originated from the microbial decomposition of fossil plant materials. The formations are interspersed with gas vents that intermittently release gas. These formations shelter a highly diversified ecosystem with brightly coloured species” (EC, 1999)²⁹.

Pockmarks are typically several tens of metres in diameter and a few metres deep and are either derived by the method above or from the thermo-catalytic destruction of kerogens in the sediments [ref 69].

Seeping gas is common in the North Sea, occurring where methane sources (Coal Measures, Kimmerage Clay, Tertiary Lignite, Pleistocene Deltaic and peaty deposits, and Holocene peat) exist in association with suitable migration pathways, such as permeable sediments, and faults [ref 69]. Pockmarks; however, only occur where the surface sediments are suitable, i.e. they are of soft silty clays. In areas where such sediments do not exist, no morphological feature is likely to be evident, despite the presence of seeping gas.

The majority of pockmarks in the North Sea have been found in the sediments of the Witch Ground formation and further north in the Flags Formation (See Figure 7.2 for details). The size of the pockmarks in this region increases towards the centre, as the sediments become finer.

²⁶ http://www.jncc.gov.uk/ProtectedSites/SACselection/SAC_habitats.asp This provides detail division of the above habitat types.

²⁷ <http://www.jncc.gov.uk/management/committee/papers03-03/jncc03P01pt1.pdf>
<http://www.jncc.gov.uk/management/committee/papers03-03/jncc03P01pt2.pdf>

²⁸ Both species are sea grasses.

²⁹ Interpretation Manual of European Habitats

Towards the edge of the Witch Ground, as the sediments thicken, the pockmarks increase in density, but decrease in size, until they become undetectable [ref 69].

Pockmarks are considered to be of potential significance to benthic ecology, as they may contain structural habitats in an otherwise unremarkable environment. Active pockmarks (of which two have been identified in the North Sea around the Witch Ground formation), may be significant as a result of the chemo-synthesisers (utilising the methane), the associated organisms that feed upon them, and the organisms associated with any methane-derived authigenic carbonate (MDAC), which is a hard substrate. "A carbonate cement structure resulting from microbial oxidation of gas emissions" [ref 68] is required for the pockmarks to be classified as pAIHs. An area of pockmarks exists approximately 25 km to the northeast of the proposed pipeline route at KP 53, (See Figure 7.1 and 7.2). However, presently it is not known whether they contain MDAC; therefore, they still have the potential to be classified as a pAIH.

Eight suspected pockmarks were found close to the pipeline at various points between KP 37 and KP 215, as identified during the project route surveys. A visual inspection of these was undertaken in March 2004. Each centre was documented by video to look for the presence of MDAC structures. As shown in Table 7.1 these turned out to be depressions probably caused by natural scouring around large erratic rocks. These are shown in Figures 7.2.

Table 7.1 Depression Survey Results

Location of Suspected Depressions	Survey Notes
Depressions 1 Given Position: KP 34	Visual survey showed a large boulder at 419117E, 6442708N. Dimensions 1.5m x 1m x 1.5m. Seabed adjacent to boulder was soft fine sand. No carbonate formation observed.
Depressions 2 Given Position: KP 38	Visual survey showed a large boulder at 418218E, 6439142N. Dimensions 1.5m x 0.6m x 2m. Seabed adjacent to boulder was soft fine sand. No carbonate formation observed.
Depressions 3 Given Position: KP 39	Visual survey showed a large boulder at 417480E, 6438208N. Dimensions 1.3m x 0.8m x 1m. Seabed adjacent to boulder was soft fine sand. No carbonate formation observed. About 40m+ pf soft trawl rope was seen fouled around the boulder, rope leading off to the NE.
Depressions 4 Given Position: KP 155	Visual survey showed a large boulder at 389125E, 6325925N. Dimensions 1.5m x 1m x 1.5m. Seabed adjacent to boulder was soft fine sand. No carbonate formation observed. Scattered shells around base of boulder.
Depressions 5 Given Position: KP 194	Visual survey showed a large boulder at 383403E, 6287702N. Dimensions 1m x 0.6m x 1.5m. Seabed adjacent to boulder was soft fine sand. No carbonate formation observed. Scattered small cobbles also seen at 383402E, 6287712N.
Depressions 6 Given Position: KP 202	Visual survey showed a large boulder at 380834E, 6280331N. Dimensions 1m x 0.6m x 1.3m. Seabed adjacent to boulder was soft fine sand. No carbonate formation observed.
Depressions 7 Given Position: KP 214	Visual survey showed a large boulder at 376909E, 6268956N. Dimensions 1m x 0.8m x 1.4m.
Depressions 8 Given Position: west of the pipeline at KP 228	Visual survey showed a large boulder at 372857E, 6256508N. Dimensions 1.8m x 0.7m x 1.2m. Seabed adjacent to boulder was soft fine sand. No carbonate formation observed.

Figure 7.1 :
Potential Offshore
Conservation Areas

Legend

- Transboundary line
 - Southern pipeline system
 - Land
- Potential Conservation Area**
- Potential Annex I pockmark habitat
 - Potential Annex I reef habitat
 - Potential Annex I sandy sediment (<20m depth)
 - Identified pockmark grounds
 - Linear Sandbanks (mobile sandwaves)
 - Linear Sandwaves

© Metac plc. Data Licence 052003.005. All Rights Reserved.
NOT TO BE USED FOR NAVIGATION

Date	25/January/2004
Projection	UTM Zone 31N
Spheroid	International 1924
Datum	ED 50
Data Source	Statoil, JNCC, DTI
File Reference	I://.P517-offshoreconservation.mxd
Checked	Jillian Barnes GIS Specialist
	Philip Wemyss Project Manager

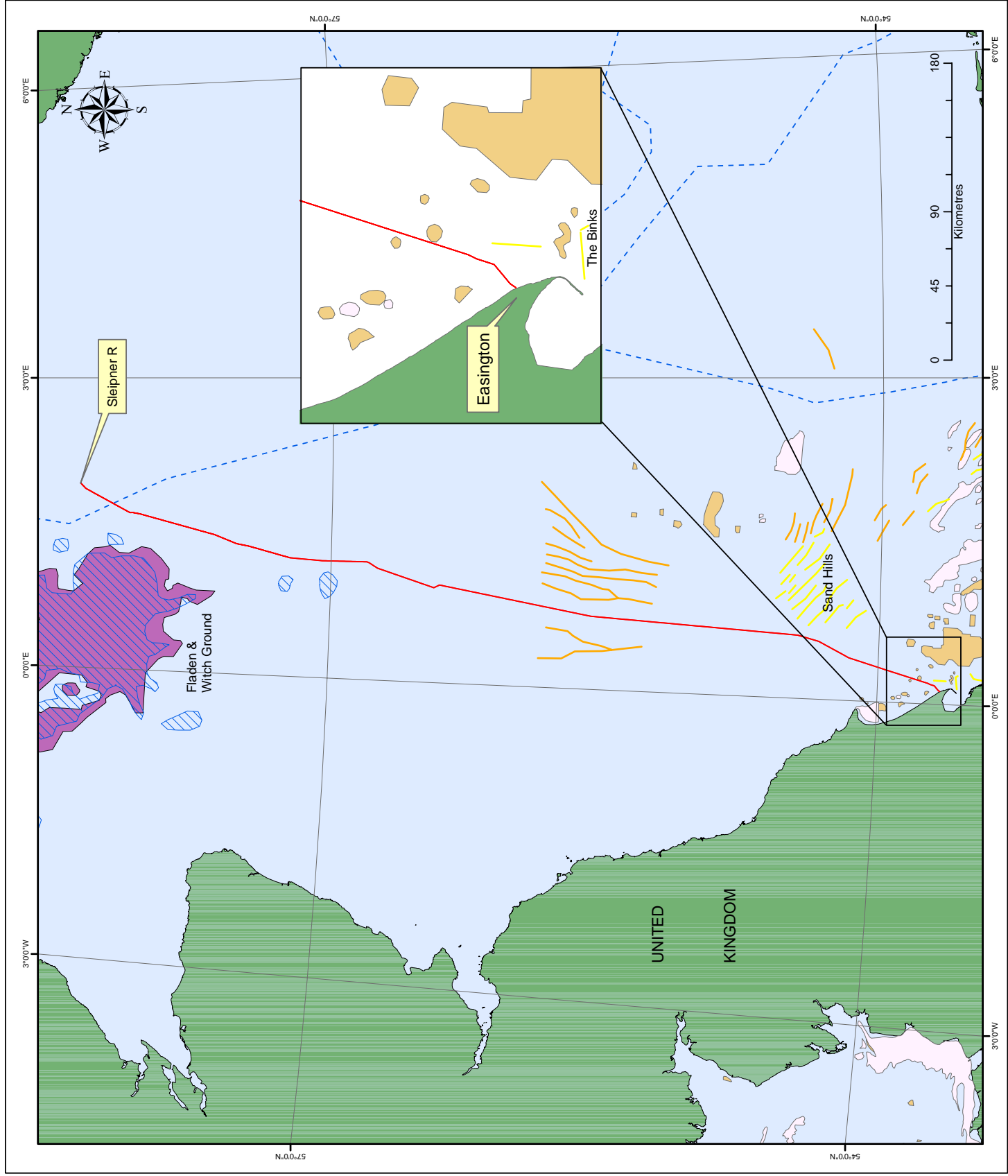

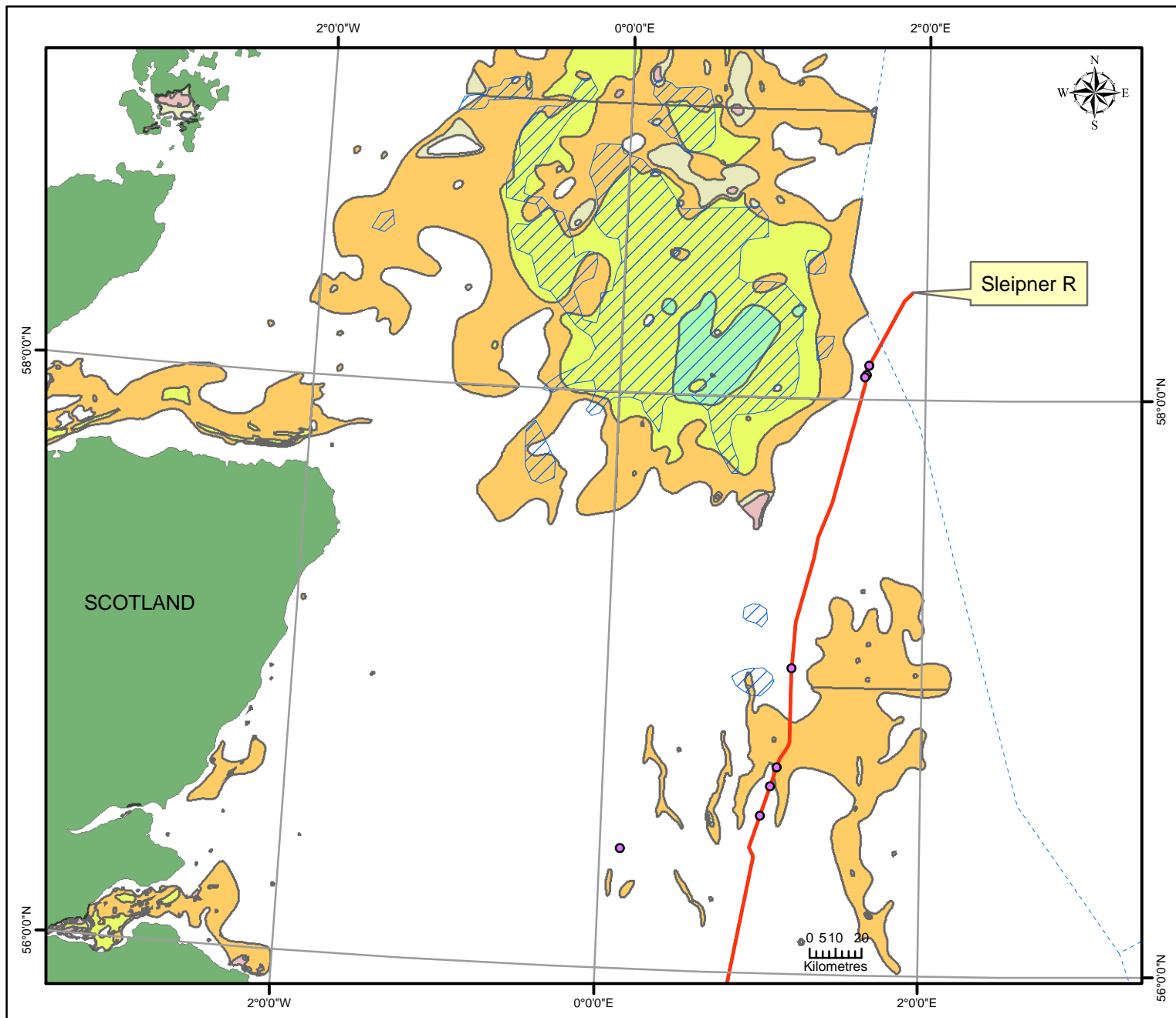

Figure 7.2
Suspected Pockmark Depressions

Legend

- Depression survey points
- - - Transboundary line
- Southern pipeline system
- Land
- ▨ pockmark areas
- Sea bed sediments (BGS)**
- Gravelly Muddy Sand
- Mud
- Muddy Sand
- Sandy Mud
- Slightly Gravelly Muddy Sand

© Metoc plc, Data Licence 052003.005. All Rights Reserved.

NOT TO BE USED FOR NAVIGATION

Date	25/February/2004	
Projection	UTM Zone 31N	
Spheroid	International 1924	
Datum	ED 50	
Data Source	Statoil, JNCC, DTI, BGS	
File Reference	I://...P517-SSS and pockmarks.mxd	
Checked	Jillian Barnes	GIS Specialist
	Philip Wemyss	Project Manager



Reefs

Reefs are defined as “submarine, or exposed at low tide, rocky substrates and biogenic concretions, which arise from the sea floor in the sublittoral zone but may extend into the littoral zone where there is an uninterrupted zonation of plant and animal communities. These reefs generally support a zonation of benthic communities of algae and animal species including concretions, encrustations and corralogenic concretions (EC, 1999). This habitat type encompasses three main types of reef; bedrock, stony and biogenic reefs.

Areas of potential reef habitat have previously been identified in the nearshore waters off Easington. These habitats represent gravel and boulder reefs (Figure 7.1). Such habitats hold a higher biological diversity than the surrounding seabed areas (the boulder reefs, in particular are noted for their importance in maintaining high species diversity). Such areas may also support *Sabellaria spinulosa* or *Sabellaria alveolata* which, when they form dense mats, may be considered of conservation importance as a biogenic reef structures.

Sabellaria spinulosa (Ross worm), is a segmented worm that builds tubes from sand or shell fragments, as shown in the photograph below. These are considered biogenic reefs and are long lived features or biogenic concretors, which arise from extremely dense aggregation of certain species.



Source: JNCC from Marine Biological Association (2003)

Figure 7.3 *Sabellaria spinulosa* Tube Structure

This species commonly occurs in solitary form throughout the UK nearshore waters. However, when conditions are suitable for high growth and proliferation, it may also occur in dense aggregations. The tubes and associated trapped sediments can build up to form reefs, which stand up to 1 m above the seabed and cover relatively large areas. Such reef structures are of high conservational importance.

A number of *Sabellaria* reefs have been identified at various locations around the UK coast, in waters depths from 20 to 45 m, the closest of which is in the Wash. They occur in areas where there is a combination of hard substrate (in order for them to attach their tubes) and active currents to supply sufficient sand particles, which they require to build their tubes. As such, the

JNCC have identified the BGS geological classification of gravelly SANDS as being of highest potential for supporting such structures.

Although Ross worm populations have been recorded in previous studies off the Easington coast, in 1992 and 1998 [refs 61 and 62], there is no evidence of them forming crusts or reefs. Previous environmental impact studies undertaken in the area, for oil and gas developments such as the recent Juno Project [ref 8], did not find any presence or indication of *Sabellaria* reefs. The side-scan data from geophysical surveys of the Juno Project suggested the existence of gravelly ridges, but that no *Sabellaria* reef features were present. The Langeled survey work included an ROV and visual inspection survey covering potential *Sabellaria spinulosa* areas along the route. This survey failed to show any evidence of this species. Figures 8.5 and 8.6 show the locations of these surveys and photographs.

Another reef forming tube worm that is present in the North Sea, is the bristle worm (*Serpula vermicularis*). However, the proposed pipeline will make its landfall well to the south of the estimated distribution area of this worm [ref 55].

The horse mussel *Modiolus modiolus* and the long-lived fan mussel *Atrina fragilis* are widely distributed species, which are found down to depths of 70 m in the North Sea. Both species are included in the UK Biodiversity Action Plan (BAP). Although none have been recorded in the area of interest, there is a remote possibility that they could be within the general area.

7.2.2 Coastal Conservation Areas

Table 7.2 lists coastal nature conservation designations on, or within 5 km, of the proposed pipeline route, including, where available, their main reasons for designation. These designations include SACs, Special Protection Areas (SPAs), Ramsar Sites, National Nature Reserves (NNR) and SSSIs.

English Nature has identified a number of protected areas that could extend into nearshore waters. One such SPA is the 'Lincolnshire coast, the Wash and North Norfolk Coast', the northern boundary of which is 0.5 km south of the Easington landfall. The geographical extent of the whole SPA is shown in Figure 7.4.















The *pipeline landfall* ES provides details on the impact of the development on coastal conservation areas.

Table 7.2: Designated Protected Coastal Areas within 5 km of the Proposed Route

Designation	Site name	Details	Approx. min. distance from the pipeline
SSSI	Easington Cliff	Geologically protected as a key site for quaternary stratigraphy.	0.5 km
SSSI	The Lagoons	Saltmarsh, shingle, sand dune, swamp, saline lagoons and pools supporting breeding ringed plover, and nationally important breeding little tern population.	2 km
SSSI	Humber Flats and Marshes; Spurn Head to Saltend Flats	Extensive areas of inter-tidal mud and sand, with fringing saltmarsh, small freshwater pools and sand dunes supporting nationally and internationally important populations of waders and shelduck.	3 km
SPA	Humber Flats, Marshes and Coast (phase 1)	Nationally or internationally important numbers of 3 breeding bird species and 21 wintering species; regularly supporting over 20,000 waterfowl.	3 km
Ramsar	Humber flats, marshes and coast (phase 1)	Internationally important numbers of various species of breeding and wintering waterbirds. Internationally important populations of ringed plover, and sanderling. Breeding grey seal colony. Human activities include tourism, recreation, commercial and recreational fishing, livestock grazing, and hunting.	3 km

Figure 7.4 :
Coastal Conservation Areas

Legend

-  Southern pipeline system
-  Land
- Depth area**
-  0-5 m
-  5-10 m
-  10-15 m
-  15-20 m
-  20-25 m
-  25-30 m
-  30-50 m
- Conservation Areas**
-  SSSI
-  NNR
-  Ramsar
-  Potential SPA extension
-  SPA

© Metoc plc. Data Licence 052003.005. All Rights Reserved.
NOT TO BE USED FOR NAVIGATION

Date	24/January/2004
Projection	UTM Zone 31N
Spheroid	International 1924
Datum	ED 50
Data Source	Metoc Charts, Statoil, EN
File Reference	I://.P517/GIS/AVProj/P517-coastalconservation.mxd
Checked	Jillian Barnes GIS Specialist
	Philip Wernys Project Manager

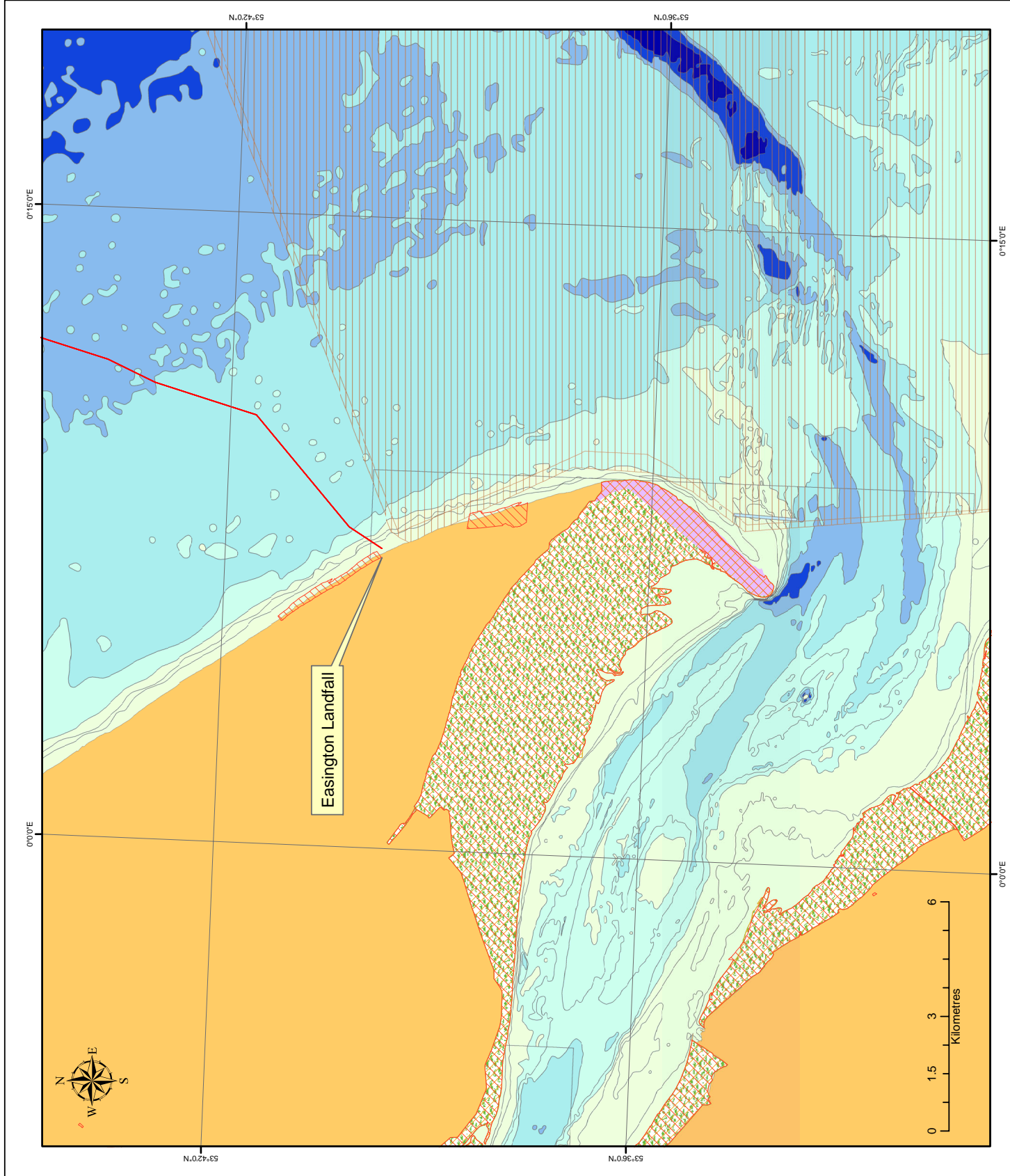

7.3 Assessment of Impacts

Sandwaves

The closest region of sandbanks, The Sand Hills region (See Figure 7.1), is located approximately 8 km east of the pipeline and will; therefore, not be affected by pipe laying operations.

Pockmarks

From KP 23 to KP 486 potential Annex I Habitats are limited to those areas of known or potential MDAC pockmarks. Potential impacts include those associated with anchoring on these, and to a lesser extent damaging such structures through laying the pipe or rock dumping/mattressing. The presence of sandy surface sediments over a large extent of the route reduces the potential for pockmarks to within KP 37 and KP 215, specifically where mud and sandy mud occur in water depths of 80 and 100 m. However, no such features were identified from the survey work undertaken along this part of the pipeline route [ref 59].

Reefs

The results from the ROV and visual inspection survey confirmed that there is no reef habitat present in the vicinity of the pipeline development. However, there still remains a highly limited potential for *S.spinulosa* reef to be present outside the development footprint. Despite *S.spinulosa* being highly sensitive to sub-stratum loss, it is not sensitive to smothering and is, similarly, not sensitive to increased turbidity levels. It exhibits intermediate sensitivity to abrasion and physical disturbance, with high recovery rates, and is highly sensitive to displacement, but still shows high recovery rates [ref 64].

In a study undertaken on the West Sole development it was shown that sediment fall-out creates a thin veneer of sediments, comprising a 1 mm deep layer, which decreased to 0.1 mm at a distance of 2 km from the dredging site. This, generally thin layer of sediments is; therefore, not likely to produce long-term significant impacts, other than that immediate to the route corridor. Consequently, any indirect effects on *S.spinulosa* will be limited.

Costal Protection Areas

The marine pipeline will not cross any costal protection areas and is not considered to have any measurable indirect or secondary effects on such areas located along the Holderness Coast and Humber Estuary. This is demonstrated through the assessment of the effects on sediment dynamics in the previous Chapter.

8 BENTHIC ECOLOGY

The following section discusses the benthic ecology in relation to the proposed pipeline development. It undertakes an assessment of the baseline environment based on secondary information and discusses where further primary information was required and collected. During the assessment, engineering options were selected that will minimise impacts and this is taken into account in the impact assessment section.

8.1 Methodology

Regional geophysical and geological data from the proposed pipeline route were initially reviewed to identify anomalies, which could form important benthic communities or habitats, and that required further assessment. These data included the following:

- more general information on the typical benthic communities found in the vicinity comes from the following sources: [ref 3, 14, 26, 27, 33, 35, 54, 66, 73 + 112].
- academic studies on the effects of sediment disturbance and recolonisation rates come from the following sources: [ref 7, 17, 20, 29, 36, 70, 71, 51 + 92].

These data were combined with a more detailed assessment of previous survey data from nearshore benthic surveys, undertaken by the Institute of Estuarine & Coastal Science of Hull University and BP Amoco. Existing Environmental Statements [ref 8] and information from the UK Benthos data base have been used where relevant.

The assessment process subsequently highlighted the requirement to undertake some new work and two ROV surveys, covering an area of gravel ridges and a stretch of gravelly sand sediment off the Holderness coast, were undertaken in 2003 (see Figures 8.5 and 8.6). In addition, a number of photographic surveys of different habitats were carried out based upon geophysical survey results and existing BGS data (Figures 8.5 and 8.6). These surveys were designed to identify the different types of community found in the vicinity of the proposed pipeline development.

An assessment of impact significance, based on the magnitude and permanency of the loss or damage to the benthic environment was used, with the following definition.

Significant	Permanent damage to the habitat resulting in loss of benthic community, damage to individuals to such an extent that an entire population or species permanently decline beyond levels of natural variability, or permanent loss of species of high or national importance.
Moderate	Damage or disturbance to habitats or populations above those experienced under natural conditions. Impacts result in slow recovery periods (>5 yrs) and/or short term loss or damage to species of national or international importance occurs.
Low	Small scale or short term disturbance to habitats or individuals, with rapid recovery rates, and no long term noticeable effects above the levels of natural variation experienced in the area. The impacts are not sufficient to be observed at the population level.
Negligible/ No Impact	Minimal impact from the work. Very minor damage, if any or to species of low ecological importance, or with immediate recovery rates.

8.2 Baseline Environment

The benthos of the North Sea has been extensively studied over the past century. The studies demonstrated clear relationships between a number of physical parameters and the structure of the benthic communities. Water depth and sediment type are typically used for defining different large-scale benthic regions in the North Sea. These communities are characterised by a number of key indicator species. The proposed pipeline route passes through a number of these recognised benthic regions as described below.

The unconsolidated sandy sediments that are predominant in this sector support benthic communities dominated by: polychaetes (such as *Ophelia lorealis* and *Nephtyes longosetosa*); crustacea; molluscs (typically bivalves); and echinoderms (brittle stars, urchins, sea potatoes, and starfish). Such communities are typically patchy in nature, with only localised areas of exposed hard ground, or other change in sediment type, likely to result in increased diversity due to the increased habitat complexity.

At its northern extremity, the proposed route passes close to benthic communities that are characterised by the deeper waters and muddy sand of the region (KP 23 to KP 45). These communities are generally homogeneous, with polychaetes dominating and crustacea, bivalve molluscs and echinoderms forming the other main groups. In addition, the less dominant community groups mainly comprise the sedentary ascidians and anthozoans.

Moving southwards the change in both the range and mobility of sediments (see Chapter 6) provides increased habitat availability; thus, a more complex community structure. These communities are able to tolerate the existing high levels of natural disturbance, in addition to the disturbance from trawling and potting. This is further heightened close to the UK landfall where there is a notably high faunal variability attributed to the surface rich heterogeneity of the sediments present [ref 10]. The photographs below show a typical North Sea sandy sediment environment taken from this region (between KP 475 and KP 543). Their locations are shown in Figure 8.2.

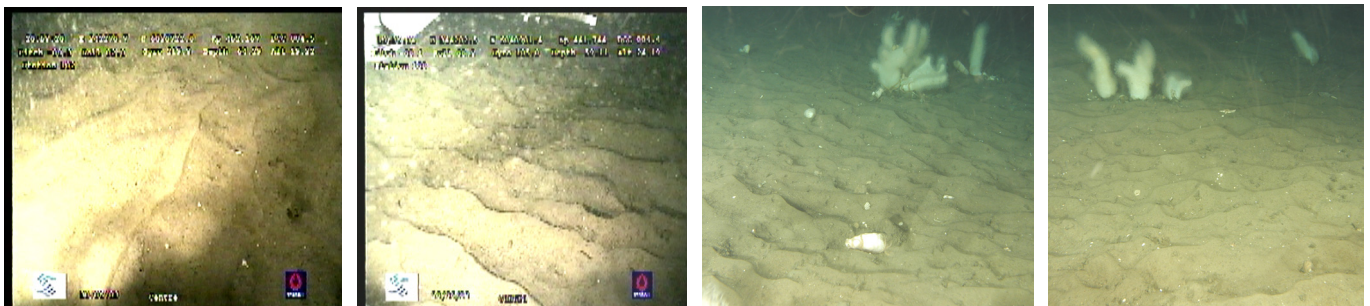

Figure 8.1 North Sea Sandy Sediment located 70 to 100 km from the Easington Coastline

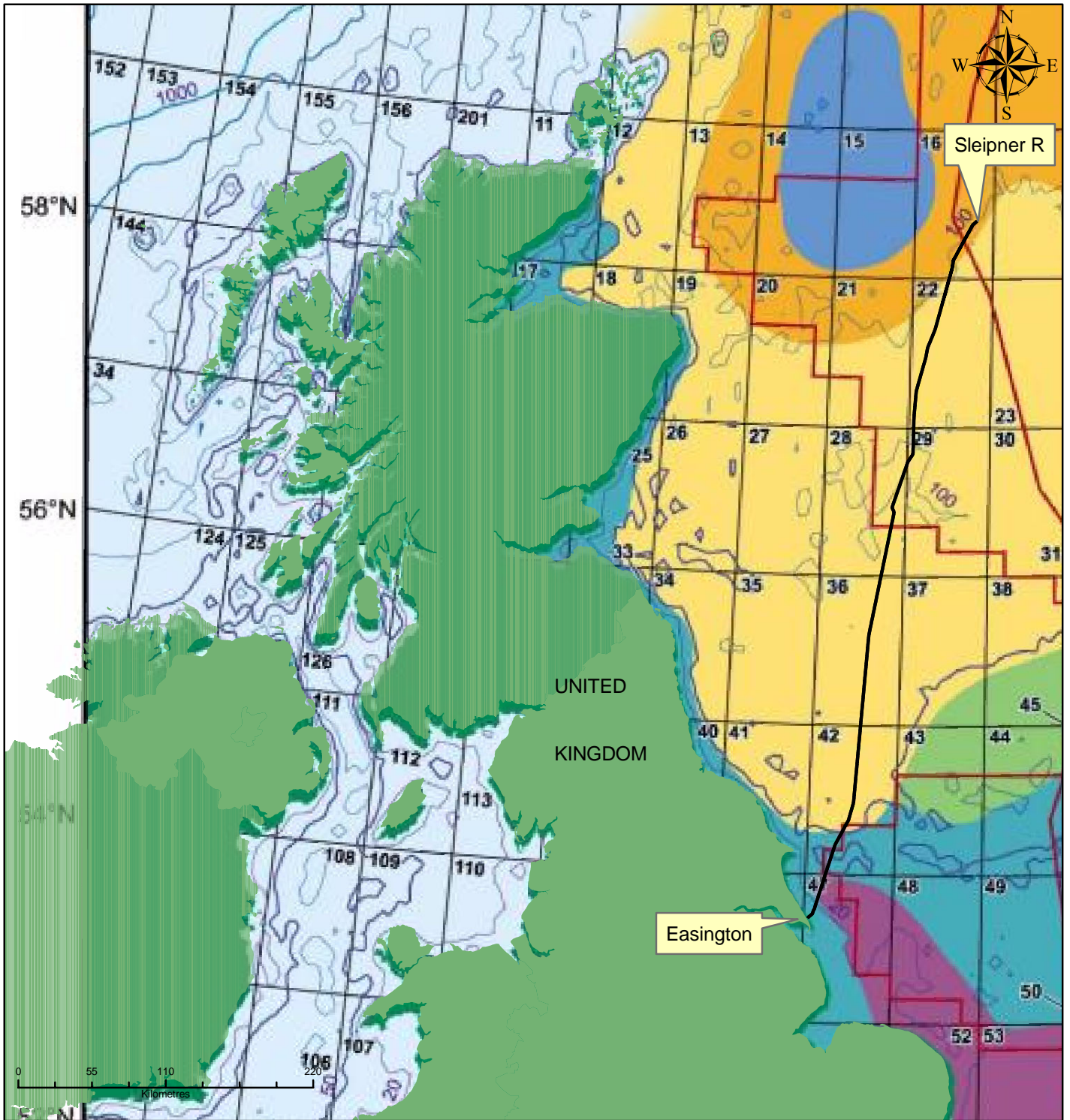









Figure 8.2
Benthic Communities in Relation
to the Proposed Pipeline Development

Legend

-  Southern pipeline system
-  Land

-  Deeper water muddy sands
-  Deeper water mud
-  Intermediate depth sands
-  Shallow fine sands
-  Shallow muddy sands
-  Shallow coarse sands

Date	13/January/2004	
Projection	UTM Zone 31N	
Spheroid	International 1924	
Datum	ED 50	
Data Source	Metoc Charts, DTI	
File Reference	I://..P517/GIS/AvProj/P517-benthic communities.mxd	
Checked	Jillian Barnes	GIS Specialist
	Philip Wemyss	Project Manager

© Metoc plc, Data Licence 052003.005. All Rights Reserved.
 NOT TO BE USED FOR NAVIGATION



As was noted in the surveys undertaken by BP in 1999 the diversity of the fauna and flora very close to the landfall, specifically in the region covered by the offshore and nearshore platforms (defined in Section 6.2.2), is restricted by the extremely high levels of sediment erosion and transport. Specifically, the proposed route in this region passes through two different benthic community types [ref 26]. They are those associated with shallow muddy sands and those with shallow coarse sands. The typical community composition of these habitats is described as comprising the polychaete, *Nephtys cirrosa*, the urchin, *Echinocardium cordatum* and the amphipod crustacean, *Urothoe poseidonis* [ref 26].

However, from the photographic, geotechnical, and previous benthic surveys of the region [refs 60, 61, and 62] it would appear that a number of additional community types are present to those observed by the DTI; namely those associated with sandy gravel, gravelly sand, muddy boulder clay, and boulder and cobble geological classifications (see section 6). These regions support a richer epibenthic community than the sandy gravel regions discussed by the DTI, with many epifaunal species present, such as the sea urchin, lobster, starfish, bryozoans and hydroids. This is shown by the figures below.

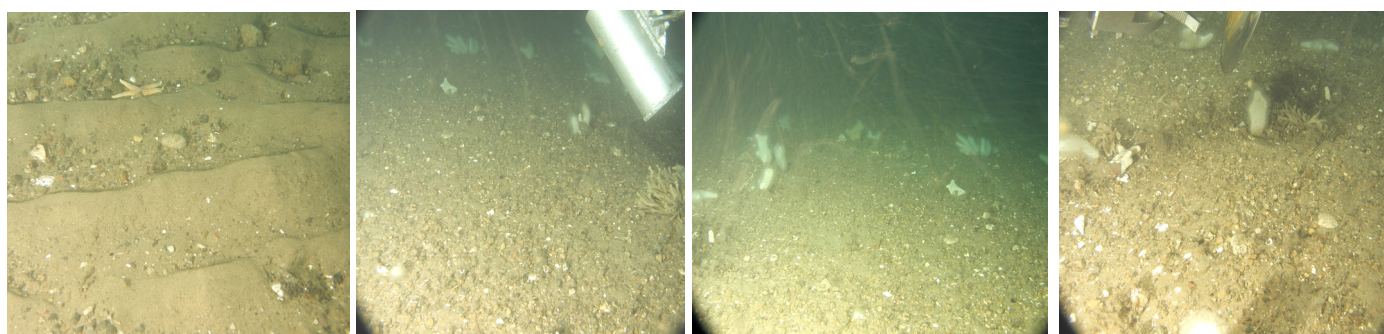

Figure 8.3: Photographs from the Coarse Sandy Gravel Regions

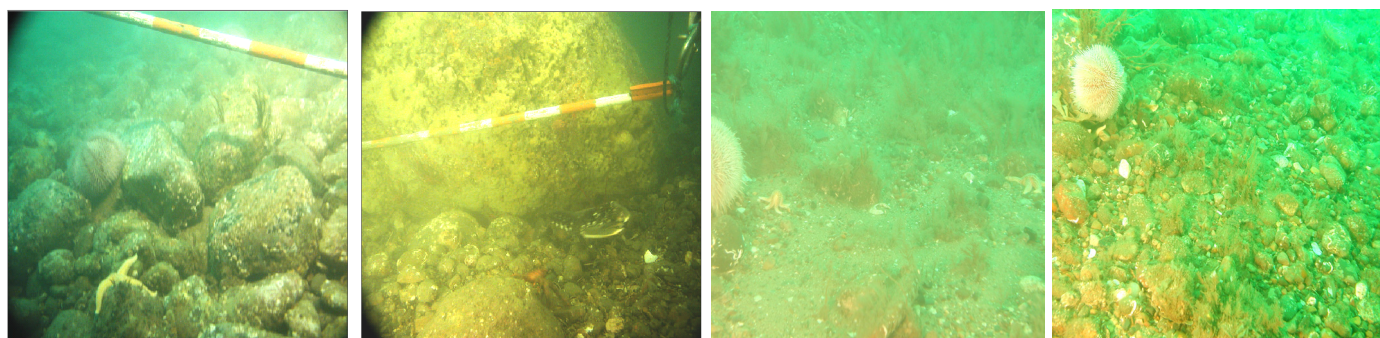
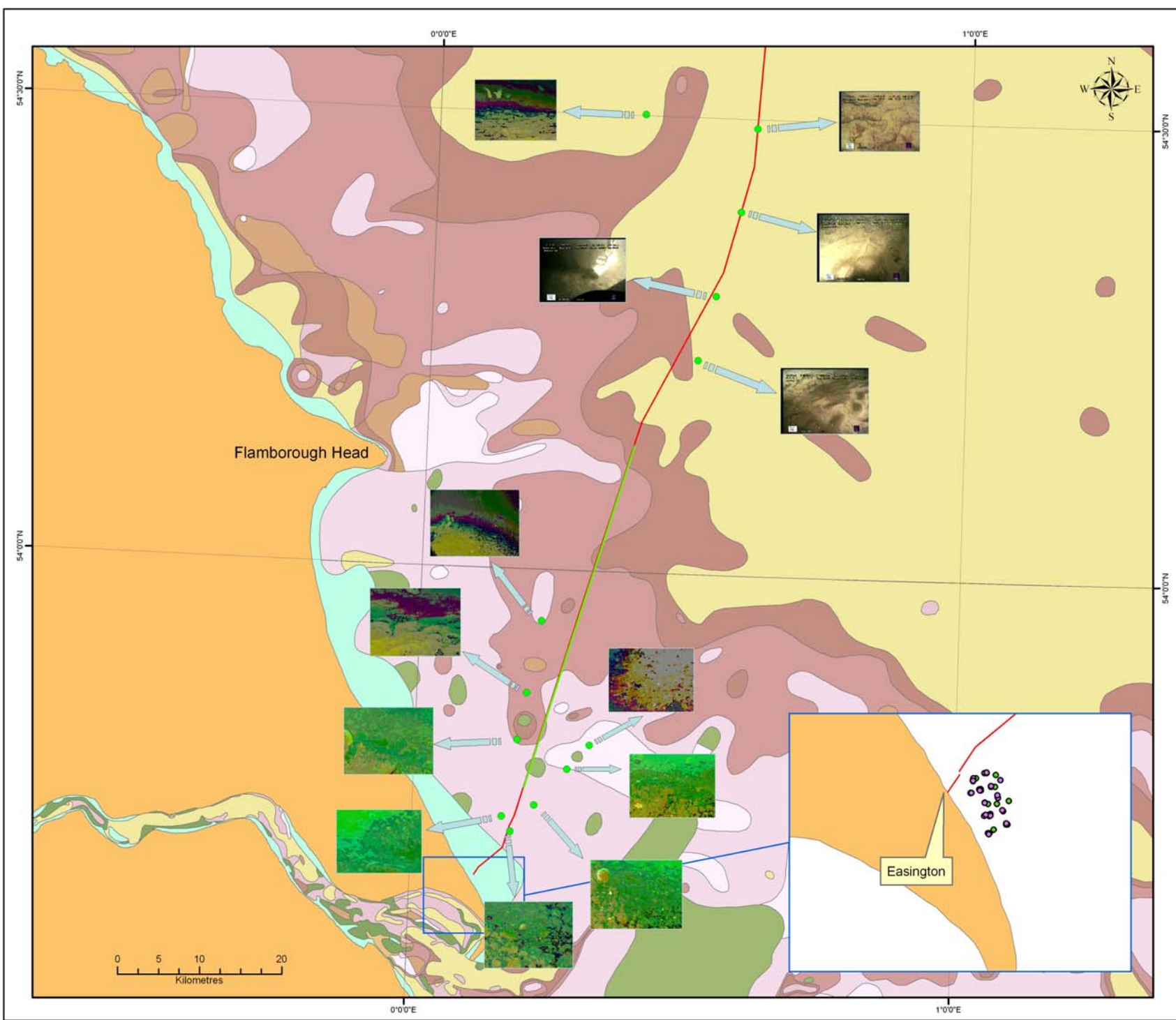

Figure 8.4: Photographed Epifaunal Species

The communities close to the landfall vary both on a short and long-term basis. The former is attributed to the effects of winter storms, leading to impoverishment [ref 10], whilst the latter reflects natural long-term variations.

In the 1992 Easington survey, which covers the region 3 km from the coastline (see Figure 8.5) the bivalve mollusc *Abra alba* was observed in high numbers on sandy gravel sediments, whilst high numbers of the annelid, *Spio armata* were recorded on mud-boulder clay and *Spio martinensis* was found on gravel sediment. *Sabellaria spinulosa* was the tenth most abundant species recorded in this survey [ref 61].

**Figure 8.5.
Benthic Sampling
and Photograph Locations**



Legend

- Easington benthic survey - 1992
 - Easington benthic survey - 1998
 - Photograph locations
 - Planned ROV survey
 - Southern pipeline system
 - Land
- BGS Seabed Sediments**
- Gravel
 - Gravelly Mud
 - Gravelly Muddy Sand
 - Gravelly Sand
 - Muddy Sand
 - Muddy Sandy Gravel
 - Sand
 - Sandy Gravel
 - Sandy Mud
 - Slightly Gravelly Muddy Sand
 - Slightly Gravelly Sand
 - Slightly Gravelly Sandy Mud

© Metoc plc, Data Licence 052003.005. All Rights Reserved.
NOT TO BE USED FOR NAVIGATION

Date	24/January/2004	
Projection	UTM Zone 31N	
Spheroid	International 1924	
Datum	ED 50	
Data Source	Metoc Charts, BGS, Snamprogetti, Statoil	
File Reference	I://.IP517-photolocations.mxd	
Checked	Jillian Barnes	GIS Specialist
	Philip Wemyss	Project Manager



**Figure 8.6
Gravel Ridge
Photograph Locations**

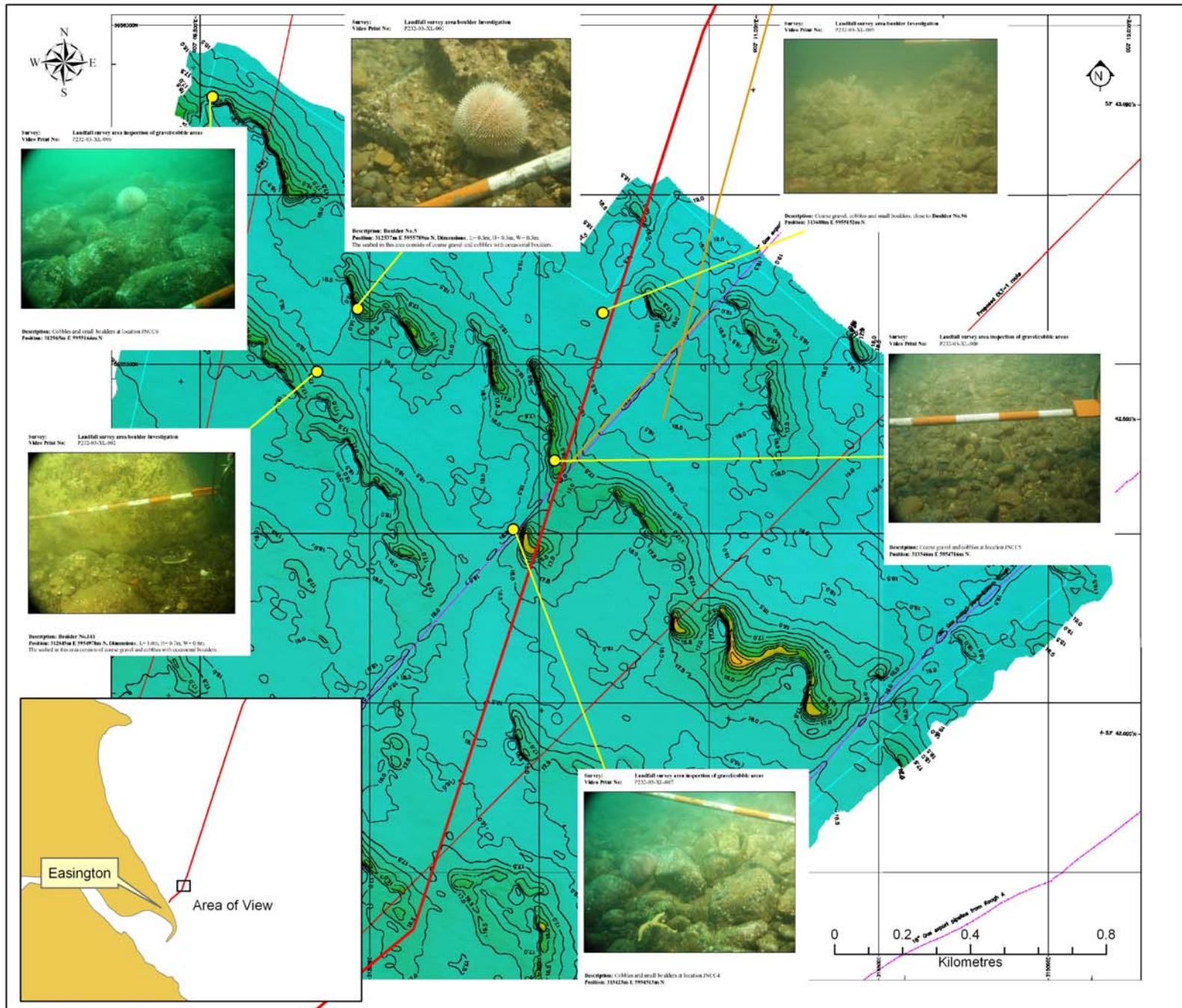

Legend

- Photograph locations
- Southern pipeline system
- ROV survey line

© Metoc plc, Data Licence 052003.005. All Rights Reserved.
NOT TO BE USED FOR NAVIGATION

Date	24/January/2004	
Projection	UTM Zone 31N	
Spheroid	International 1924	
Datum	ED 50	
Data Source	BGS, Snamprogetti, Statoil	
File Reference	I://.IP517-gravelridgephotos.mxd	
Checked	Jillian Barnes	GIS Specialist
	Philip Wemyss	Project Manager



In the 1992 Easington survey, which covers the region 3 km from the coastline (see Figure 8.5) the bivalve mollusc *Abra alba* was observed in high numbers on sandy gravel sediments, whilst high numbers of the annelid, *Spio armata* were recorded on mud-boulder clay and *Spio martinensis* was found on gravel sediment. *Sabellaria spinulosa* was the tenth most abundant species recorded in this survey [ref 61].

Long-term variations were shown through re-surveying at the same location in 1998, which revealed high numbers of the polychaetes, *Spiophanes bombyx*, present on muddy sand and *Lanice conchilega* on sandy gravel. It was also noted that *Sabellaria spinulosa* still remained high in number being the second most abundant species recorded [ref 62].

In 1998 the earlier studies were expanded to produce a typical ecological succession community schematic of the region [ref 92]. In categorising species into: *colonisation*; *transitional* and *equilibrium*, to represent a move from disturbance to stabilisation, it was concluded that the species identified in the previous Easington surveys fall between the *transitional* and *equilibrium* stages, with representatives in both groups. This confirms, what was noted above, specifically that species composition corresponds to habitat type, with areas of stabilised substrata (such as cobbles and boulders) supporting stable communities, and areas of less stable sediment (such as sands) being more prone to disturbance; therefore, less stable communities. It was also observed that “no nationally rare or scarce seabed species were identified off the Easington coast” [ref 3].

8.3 Assessment of Impacts

8.3.1 Construction

Seabed Intervention Works

The requirement to undertake seabed intervention works will result in the loss, disturbance and disaggregation of sediments, which, in turn, will result in habitat loss and localised mortality. This is in addition to, potential smothering of species and habitats where the spoil is dumped and/or settles out. Specifically, pre-lay sweeping is to be carried out within sandwaves between KP 451 and KP 521 and post-lay trenching at spot locations between KP 23 and KP 451 (up to 50 km) and then continually up to KP 521. Studies in the North Sea have shown that the seabed in these regions will rapidly recover from this type of activity.

Communities of such unconsolidated sandy habitats are likely to show tolerance to disturbance and have relatively fast recovery rates [ref 20]. Trawl tests revealed that there were no detectable effects on the benthic communities in such sediments [ref 70]. In areas where the sediments are stable, short-term changes in species composition may occur, with mobile scavenging species, such as crabs and echinoderms, moving into the disturbed area after the intervention work. However, no lasting effects were observed after three months [ref 70]. Although the sweeping/trenching work may be slightly more disruptive than trawling, the results show that communities of such sediments are scarcely affected by disturbance due to the unconsolidated nature of these surface sediments.

Where dredging and trenching occurs (KP 521- KP 543) the use of the cutter suction dredger and trench/backfilling plough will effectively destroy any benthic species directly in its path, and as the volumes increase close to the shore the effects are likely to become more marked. Dumping or ploughing the materials alongside the excavated channel will cause smothering of

the seabed species. These impacts will be only short-term; furthermore, given that footprint represents a very small area compared to the whole habitat, coupled with the lack of evidence of rare or scarce species, the overall significance is considered to be low. The many mobile species associated with the nearshore sediments will rapidly re-colonise the area after the backfilling has been completed. This process will be quicker where dredging occurs as the natural rate of backfilling is high and where manual backfilling is required it will be undertaken very shortly after the trenching (see section 3).

To support this argument, studies on dredging work in similar sediments, where some 50,000 tonnes of sediment were removed in a confined area shows that the dominant species recolonise the area quickly following the cessation of disturbance. After 12 months, significant increases in individual numbers were observed [ref 71]. Direct mortality mostly affected the sessile and fragile organisms common to the more stable, coarse sediment regions.

Smothering from the spoil arising from the intervention works will be temporary and affect organisms in the immediate vicinity of the dredged/trenched channel. The finer sediments, generated as a result of the works, will be brought into suspension and will be rapidly dispersed by the currents in the area. The organisms that will be most affected by the disturbance to sediments are the more delicate species exhibit filter and suspension feeding characteristics [ref 50 and ref 92]. Such organisms are more common to stable habitats. Short-term localised changes in community structure in the affected areas may occur, with more opportunistic, scavenging invertebrates moving in to feed on organisms exposed or killed by the disturbance.

Where the pipeline is exposed (KP 23 to KP 451), or partially buried (KP 486 to KP 528), its physical presence will prevent the seabed from returning to its natural state. However, the affected area will be only the width of the pipeline itself (44 inches) and will, therefore, have no significant effect on the benthic environment as a whole.

Pipe-laying

Benthic communities in the immediate vicinity of the pipeline will suffer impact from the laying of the pipeline on the seabed and associated sediment disturbance. However, this disturbance is expected to be minimal. Any effects will be short-term and localised, with high recovery rates due to the nature of the communities present.

Anchor Mounds

The use of anchors may result in the creation of anchor mounds or scars, the scale and severity of which will vary along the route, depending on sediment type and depth. It is possible that an area of 40 m² may be affected by each anchor drop. Furthermore, the anchor wires may also drag on the seabed with the natural backfilling of finer or disaggregated sediments into the anchor scars causing localised habitat change. However, the affected areas would be insignificant in comparison to large extents of the existing habitats. As with the intervention works, this activity will result in direct mortality at the anchor point and indirect smothering through sediment dispersion and settlement. However, the areas involved are considerably less than the intervention works.

Communities from more immobile habitats such as the cobbles and boulder areas, which support more fragile epifauna benthic communities, are likely to be more sensitive to this disturbance than the communities associated with unconsolidated sandy sediments (covering much of the

route). The communities, associated with unconsolidated sandy sediments, are relatively tolerant to natural disturbance and will; therefore, show quick recovery rates given these areas are active. The most pronounced affects will be where hard cohesive deposits (clays) are near the surface. Beyond KP 425 where the whole region is underlain by surficial deposits of clay. In this region the effects; however, will be short-lived as the disturbed material will be rapidly redistributed by the energetic environment and then recolonised by similar fauna [ref 10].

Rock Dumping and Mattress Placement

The areas subjected to rock dumping represent a very small percentage of the total area disturbed by the pipeline. In these areas this activity will result in: small-scale disturbance; direct mortality of sessile species; loss of, and change in, original habitat/ecosystem; and the creation of an alternative habitat due to the addition of a hard substrate. Additional smothering by the settlement of the suspended sediments in the close vicinity to the works will occur and may lead to the loss of sessile and more fragile species. Nonetheless, this activity will be kept to a minimum and will only occur in areas that require the additional material for safety reasons.

This introduction of alternative materials to the baseline environment may lead to different communities colonising the area around the rock or mattresses. Consequently, it may result in increased species diversity and the provision of a refuge for benthic species in areas of, otherwise, barren, sandy sediments.

Cofferdam Construction and Floating Channel

The work from KP 542 –KP 543 will be undertaken between February and August 2005. During construction the surficial geology will be removed, reworked and replaced in a disaggregated manner. This will destroy any community structure within the area. Furthermore, the release of suspended sediments outside the construction work area, in what are very shallow waters may smother habitat and result in some species loss. Smothering potential will be most extreme in the region to the south of the works where the excavated sediments are to be temporarily stored. However, the communities in this landfall region extend over large areas of the North Sea; therefore, impacts are not expected to be significant as the works are confined to a comparatively small area. Outside of this area, where smothering is a potential risk, the energetic environment off the Holderness Coast supports a community structure that is tolerant to the high levels of naturally suspended sediments. Furthermore, this energetic environment constantly alters the biological community. Consequently, any effects from the pipeline will be masked by these natural conditions.

The subsequent excavation and storage of material may lead to the loss of mobile sediments and alteration in the properties of the clay. However, it is likely that reinstating the area within the cofferdam through the disaggregated return of the remaining stored sediments will affect the reestablishment of the benthic communities associated within the impacted region.

Discharge of Flush Water

The flush water will be discharged to the sea through a dedicated discharge pipeline. The flush water will be deoxygenated and may contain residual trace oxygen scavenger. It could; therefore, have a limited effect on shellfish immediately within the discharge zone. The total discharge rate (up to 1,600 m³/hr) will have a transient localised effect on the ambient sea water quality and may result in some erosion of the seabed directly in its path. This will directly affect

the benthos, especially any fragile sessile organisms. The area of influence would; however, be limited to the immediate proximity of the discharge point, and the effects are considered negligible³⁰.

8.3.2 Operation

Scour is the only anticipated operational effect and will be restricted to where the pipeline is partially buried or lays at the seabed (specifically from KP 23 to KP 521). The level of scour along any structure laid on the seabed depends on interrelated factors, such as current velocity, direction of current in relation to the pipeline orientation, and sediment type. Scouring of pipeline materials can affect fragile organisms in the immediate vicinity. However, in the case of this development scouring within open water areas, where the pipeline is to remain on the seabed or be partially buried, is not expected to be a major concern as the bottom currents at water depths of greater than approximately 50 m (KP 480) are not of sufficient to generate scouring issues (see section 6).

³⁰ The dispersion of this deoxygenated water is to be modelled for dispersion along the Easington coastline. The results will be presented to the Environment Agency as part of the landfall permit-to-discharge process.

9 FINFISH AND SHELLFISH

This section provides a brief description of the finfish and main commercial shellfish that occur in the vicinity of the proposed pipeline route. The potential effects of the development on shellfish when considered as part of the benthic community, are discussed in section 8. This section provides details regarding sensitive periods for key species and identifies, and assesses, the main impacts from the development.

9.1 Methodology

Information was derived from secondary sources including: [ref 10, 26, 27, 29, 53, 55 and 111]; FRS; CEFAS; the United Kingdom Marine Special area of Conservation (UKmSAC) Project (2004); Sea Fisheries Inspectorate (SFI); and local source primary data.

An assessment of potential impacts on finfish and shellfish was based on the percentage loss of the total spawning, nursery and shellfish grounds.

Significant Near total permanent loss of a ground(s) such that mortality levels occur at population level; damage to individuals to such an extent that the viability of the population is permanently affected; and/or long term damage to a population of high commercial or conservation importance.

Moderate A sufficient percentage loss in grounds that there will be some measurable effects on fecundity that destabilise the population dynamics over several life cycles; and/or long term damage to individuals of commercial importance.

Low A percentage loss that will have affects at the individual level and would not affect the population as a whole. They do not extend beyond one life-cycle where beyond this period the population will function normally. This may also include the limited mortality of individuals.

**Negligible/
No Impact** Less than 1 % direct/indirect loss of a certain ground that would not compromise either its fecundity or the functioning of the population.

Impact significant is greater if the species is either commercially important or rare.

9.2 Baseline Environment

9.2.1 Demersal Species

Demersal fish are those that dwell on, or near to, the seabed consequently, the intrusive nature of pipeline construction makes them more vulnerable than pelagic species found in the water column. Demersal species are sub-divided into flatfish and round fish in this section.

Flatfish are dorso-ventrally flattened species that spend much of their time at the sediment/water column interface (in effect just above the seabed). Common species likely to occur in the area are: plaice (*Pleuronectes platessa*); lemon sole (*Microstomas kitt*); witch sole (*Glyptocephalus cynoglossus*); sole (*Solea solea*); dab (*Limanda limanda*); turbot (*Psetta maxima*); and skate (*Raja batis*). NESFC report that in addition to the above, brill (*Scophthalmus rhombus*) and flounder (*Platichthys flesus*) are also found in the area.

Round fish include species such as: cod (*Gadus morhua*); whiting (*Merlangius merlangus*); haddock (*Melanogrammus aeglefinus*); saithe or coalfish (*Pollachius virens*); angler or monkfish (*Lophius piscatorius*); red gurnard (*Aspitrigla cuculus*); and spurdog (*Squalus acanthias*). These species spend the majority of their time on, or near to the seabed, but in numbers generally above those of the flatfish. One notable species to the region is the sandeel (*Ammodytes marinus*), which react to low light levels by burying themselves into the sediments during the winter and at night. However, during daylight hours, in spring, summer and autumn, sandeel feed on plankton in the open-water column. Sandeel spawn from November-to-February, with the larval stages remaining planktonic until May, at which point they return to the seabed. NESFC report that additionally, tope (*Galeorhinus galeus*), smoothhound (*Mustelus henlei*), and bass (*Dicentrarchus labrax*) are also found in the area. These are mainly caught for recreational purpose (see Section 13.2.6). Demersal species are common along the whole route indicated by the high proportions of representative species caught throughout 2002 (see section 11).

9.2.2 Pelagic Species

Pelagic species are those that inhabit the open-water column and commonly congregate in large shoals for safety. They often undertake large scale migrations between breeding and seasonal feeding areas. Pelagic species common to the North Sea are herring (*Clupea harengus*), mackerel (*Scomber scombrus*), Norway pout (*Trisopterus esmarkii*) and sprat (*Sprattus sprattus*). Herring is the most commercially important pelagic species along the route and the only species caught in any significant amount according to the data from 2002. Herring is not only of high commercial importance but it is also a demersal spawner; therefore, at greater risk to impacts from the development. Moreover, herring spawning grounds are crossed by the pipeline route (see Figure 9.1 for details). The Table below provides details of the spawning and nursery areas in relation to the pipeline route. A visual representation of these spawning and nursery areas are provided in Figures 9.1 and 9.2.

Table 9.1 Spawning and Nursery Areas of Finfish on the Pipeline Route

Species	Latin name	Spawning	Spawning	Nursery
Demersal Species				
Cod	<i>Gadus morhua</i>	Jan-Apr	YES	NO
Whiting	<i>Merlangius merlangus</i>	Feb-Jun	YES	YES
Plaice	<i>Pleuronectes platessa</i>	Dec-Mar	YES	YES
Sandeel	<i>Ammodytidae spp</i>	Nov-Feb	YES	YES
Lemon sole	<i>Microstomus kitt</i>	Apr-Sep	YES	YES
Sole	<i>Solea solea</i>	Mar-May	YES	NO
Pelagic Species				
Herring	<i>Clupea harengus</i>	Aug-Oct	YES	YES
Mackerel	<i>Scomber scombrus</i>	May-Aug	YES	NO
Sprat	<i>Sprattus sprattus</i>	May-Aug	YES	YES
Norway pout	<i>Trisopterus esmarkii</i>	Dec-Apr	YES	YES

Note: Light grey shading depicts demersal spawning species. Although the species mentioned above have nursery and spawning grounds local to the pipeline they would not be directly impacted through the construction works.

Source: [ref 23]

9.2.3 Shellfish

Many shellfish in the North Sea are commercially important. In the nearshore regions they are fished intensely (section 11). This Chapter discusses the biology of species that are of high commercial importance (see Figure 9.3). The main species are considered in detail below.

European lobsters (*Homarus gammarus*) occur on rocky seabeds from approximately 60 m to MLW (KP 475 to KP 543) [ref 53]. They inhabit the holes between the boulders and cobbles. The areas off the coast, near the proposed Easington landfall, support large numbers of lobster, indicated by the high catch statistics in the clay 'huts' area. They spawn year-round with peak activity occurring in the summer-to-early autumn [ref 10]. Lobsters seek shelter under rocks, boulders and in crevices prior to, during, and shortly after, moulting (a process known as *ecdysis*). During this period they are at their most sensitive as the males will be holding onto the females in such shelters and will, therefore, be less likely to avoid disturbance. The females remain in a *berried* (egg-carrying) state for up to 10 months. Studies show the presence of suitable habitat (cobbles and boulders) which provides shelter is key to the survival and successful development of the juvenile lobsters [ref 78].

Norway lobster (*Nephrops norvegicus*) (also known as Scampi, Langoustine, and Dublin Bay Prawn) are principally found off the Northumberland coast and in the Silver Pit area off the Humber, in water depths greater than 20 m [ref 53]. They do not extensively migrate and live in the area in which they originally settled as larvae [ref 26]. The pipeline does not run through the main region of expected distribution of this species [ref 55]; however, they are present along the route in relatively high numbers as indicated by the catch statistics in section 11. At the UK/Norway Median Line (KP 23) the pipeline passes close to the Norway lobster spawning grounds and remains parallel to the grounds until 57.5° N (KP 104). The spawning and nursery areas are shown in Figures 9.1 and 9.2 respectively. The Norway lobster spawns all year round but the peak activity is during April-to-June [ref 27].

The edible crab (*Cancer pagurus*) is widespread, occurring on mixed substrates of sand, gravel and rock around the coasts of England and Scotland. The spawning activity of the edible crab is most intensive off the east coast of England, to the north east of the Humber [ref 27]. Spawning starts in November and lasts for several months. Whilst the female crabs are spawning they spend six-to-nine months in the *berried* state in shelters on the seabed before releasing their young [ref 5].

The velvet crab (*Necora puber*) is found on stony and rocky substrata in the intertidal zone and in shallow coastal waters. Inshore reef areas; therefore, form an important part of the habitat for the velvet crab. The main fishery season for this species is during the spring and summer. Off the Holderness coast the velvet crab fishery has seen rapid growth in recent years (NESFC, 2002).

Atlantic prawn (*Pandalus borealis*) spawning grounds also occur on the pipeline route from the UK/Norway Median Line (KP 23) up to 56.5° N (KP 218). The spawning period occurs between October and November [ref 27].

9.3 Assessment of Impacts

Activities that have the potential to impact fish and shellfish include; seabed intervention work (see section 3) anchoring, rock dumping and mattresses, and the discharge of flush water. The

intrusive nature of the work will have greater potential impact on species in contact with, or close proximity to, the sediments including (demersal spawners) with other species showing some level of avoidance of the area. If construction works occur during spawning periods when the species are at their most vulnerable impacts will also be greater.

9.3.1 Construction

Seabed Intervention Works and Cofferdam Construction

Seabed intervention works and construction of the cofferdam will result in the loss, disturbance and disaggregation of sediments, which in turn will result in habitat loss and localised mortality. This is additional to, smothering of species and habitats where the spoil is dumped and/or settles out. Demersal fish species, demersally spawning pelagic species and shellfish in the vicinity will be temporarily affected by the works, which could lead to mortality of individuals.

Figure 9.1 Finfish and Norway Lobster Spawning Areas

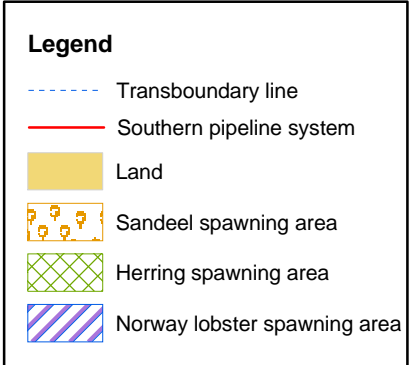
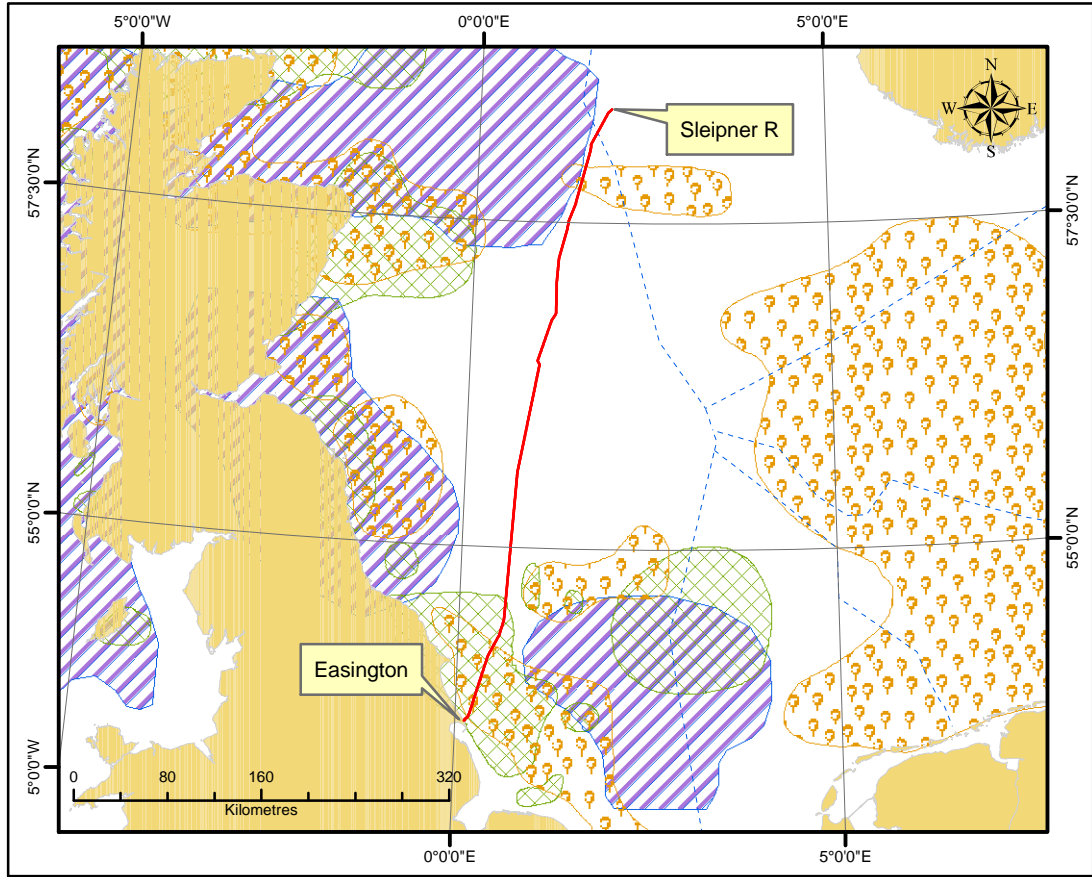
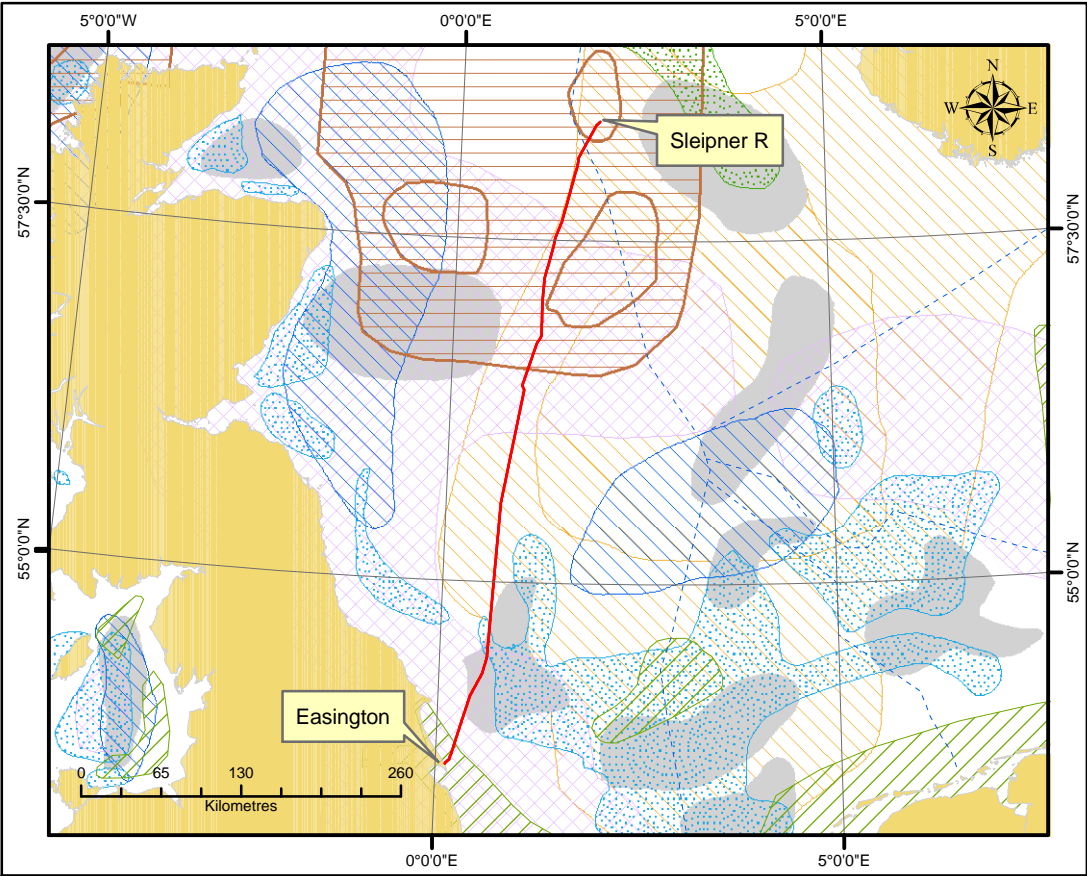
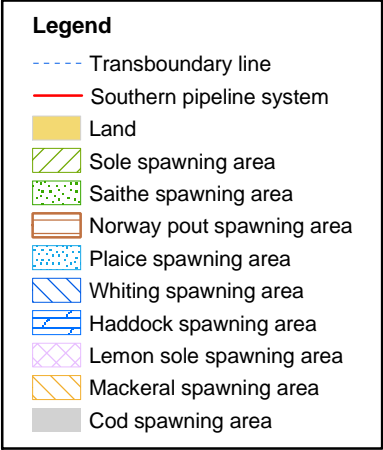

Note : spawning areas are georeferenced from original source
 © Metoc plc, Data Licence 052003.005. All Rights Reserved.
 NOT TO BE USED FOR NAVIGATION

Date	24/January/2004	
Projection	UTM Zone 31N	
Spheroid	International 1924	
Datum	ED_50	
Data Source	Statoil, CEFAS	
File Reference	I://...P517/GIS/AvProj/P517-spawning areas.mxd	
Checked	Jillian Barnes	GIS Specialist
	Philip Wemyss	Project Manager



Figure 9.2 Finfish and Norway Lobster Nursery Areas

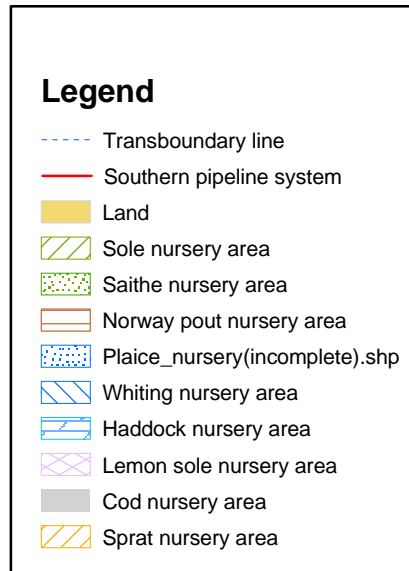
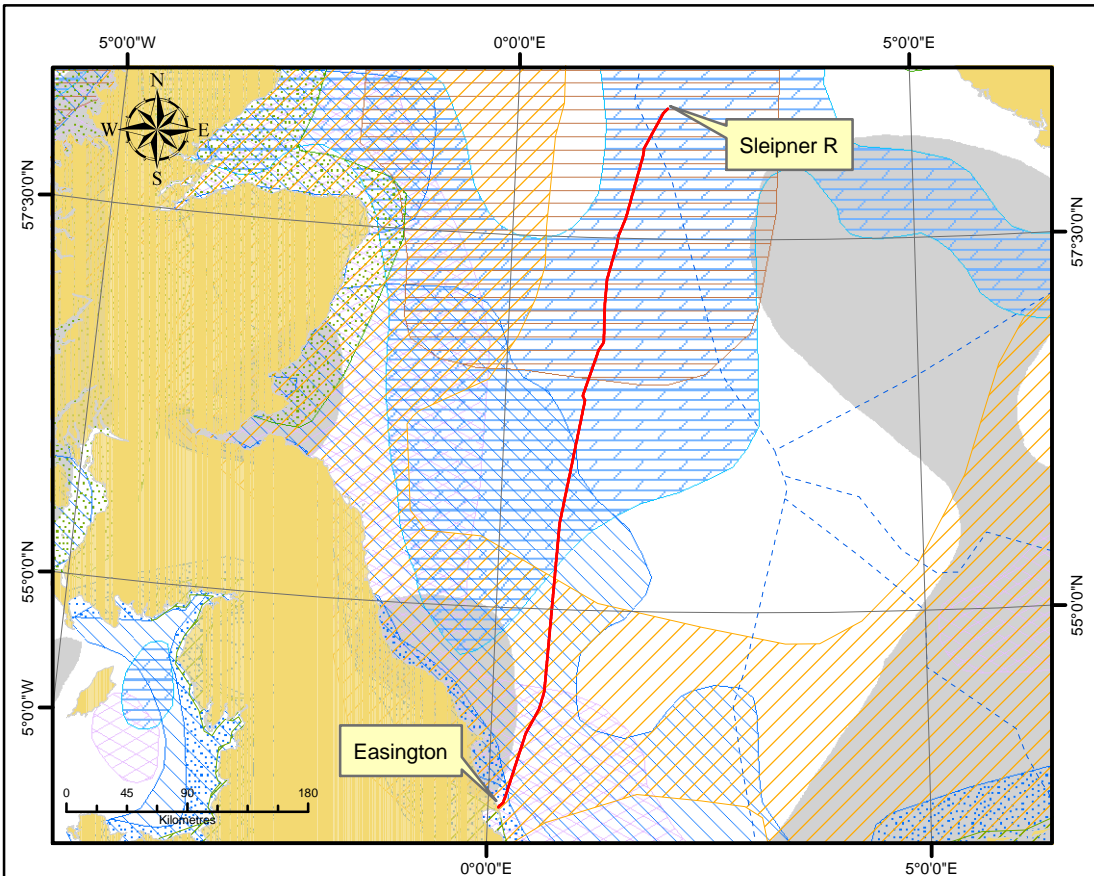
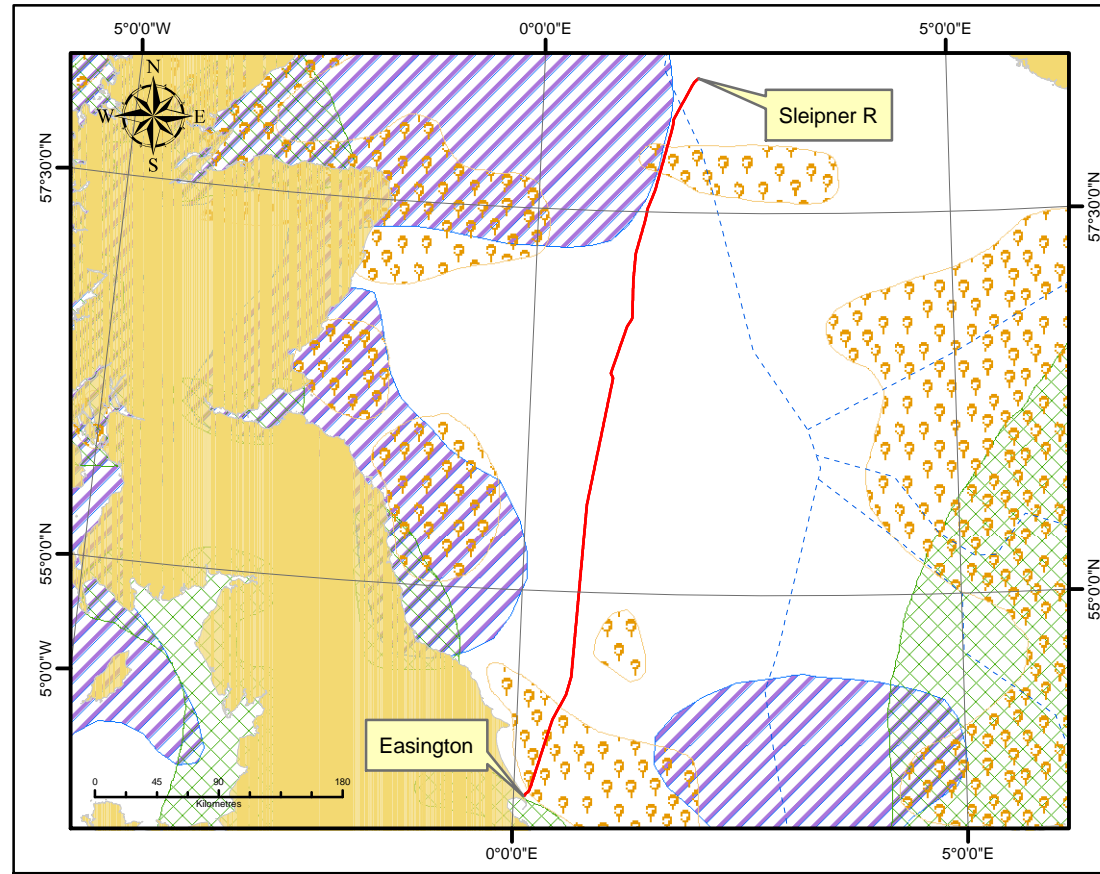
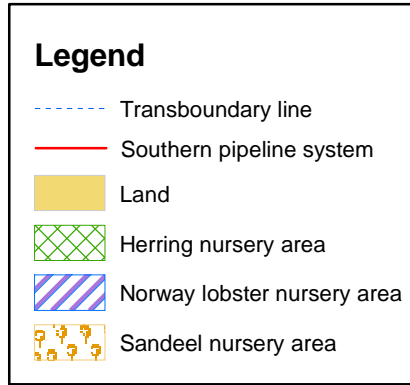

Note : nursery areas are roughly redrawn
 © Metoc plc, Data Licence 052003.005. All Rights Reserved.
 NOT TO BE USED FOR NAVIGATION

Date	25/January/2004	
Projection	UTM Zone 31N	
Spheroid	International 1924	
Datum	ED 50	
Data Source	Statoil, CEFAS	
File Reference	I://...P517/GIS/AvProj/P517-nursery areas.mxd	
Checked	Jillian Barnes	GIS Specialist
	Philip Wemyss	Project Manager



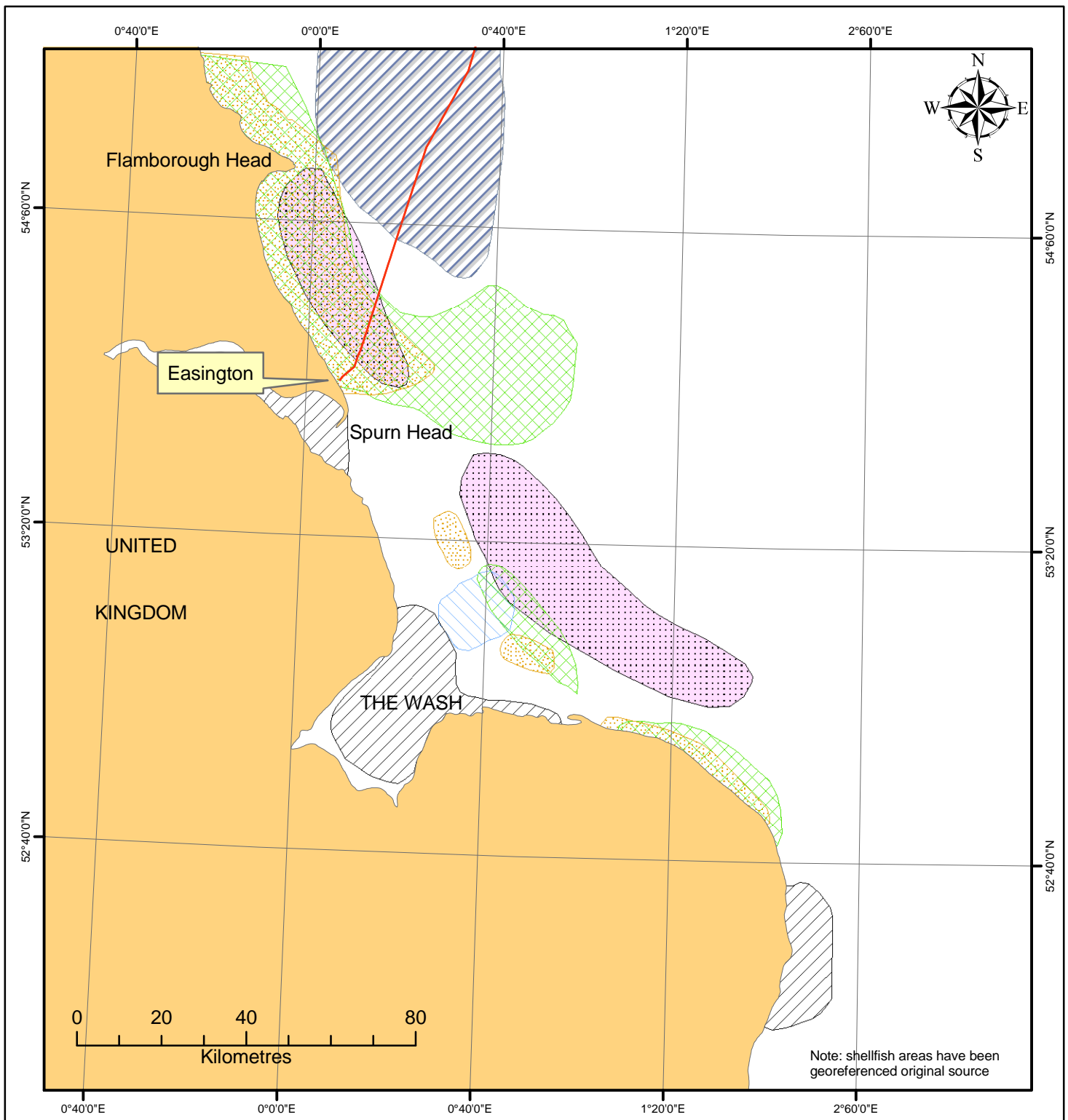









Note: shellfish areas have been georeferenced original source

Figure 9.3 Commercially Important Shellfish Areas

Legend

-  Southern pipeline system
-  Land
-  European lobster
-  Brown shrimp
-  Pink prawn
-  Edible crab
-  Whelks
-  Queen scallop

Date	14/January/2004	
Projection	UTM Zone 31N	
Spheroid	International 1924	
Datum	ED 50	
Data Source	Barne et al (1995)	
File Reference	I://P517...commercialshellfishareas.mxd	
Checked	Jillian Barnes	GIS Specialist
	Philip Wemyss	Project Manager



Table 9.2 Sensitive Species that have Spawning and Nursery Periods at Locations that Coincide with Seabed Intervention Work/Pipelaying

General KP Points	KP Points	J	F	M	A	M	J	J	A	S	O	N	D	
KP 23 - KP 520s	Activity/Period													
	spot post-lay trenching Period	23 - 451												
	Post-Lay Trenching Period	451 - 521												
	Pre-lay sweeping Period	451 - 521												
	LB 200 Pipelaying Period	23 - 360												
	LB 200 Pipelaying Period	360 - 410												
	LB 200 Pipelaying Period	410 - 528												
	Spawning Periods													
	Herring	434 - 543								#	#*	*		
	Cod	418 - 494				#								
	Lemon Sole	88 - 266 & 442 - 543				#*	#*	#*		#	#*			
	Nursery Period													
	Whiting	267 - 528				#*	#*	#*		#				
Lemon Sole	447 - 543						#*		#	#*	*			
Sandeel	55 - 75 & 473 - 539				#*									
KP 520s - KP 542	Activity/Period													
	Pre-Dredging Period	521 - 550 m from MLW												
	Tog Mor Pipelaying Period	528 - 542												
	Spawning Periods													
	Herring	434 - 543								#				
	Lemon Sole	88 - 266 & 442 - 543					*	#*	#*	#				
	Sole	524 - 543					*							
	Nursery Period													
	Whiting	267 - 528					*	#*	#*	#				
	Lemon Sole	447 - 543						#*	#*	#				
Plaice	530 - 543					*								
Sandeel	55 - 75 & 473 - 539													
K 542 - KP 543	Activity/Period													
	Cofferdam Construction & Excavation Period	90 m to MLW												
	Floating Channel Excavation Window	550 m - 90 m from MLW												
	Pipeline Pull In Window	542 - 543												
	Floating Channel Backfilling and Cofferdam Removal Window	542 - 543												
	Spawning Periods													
	Herring	434 - 543								*				
	Lemon Sole	88 - 266 & 442 - 543				*	#*	#*	*	*				
	Sole	524 - 543			*	*	#*							
	Nursery Period													
Lemon Sole	447 - 543						#*	*	*					
Plaice	530 - 543		*	*	*	#*	#*	*	*					

* - Interaction between spawning/nursery period and intervention works; and # - Interaction between spawning/nursery period and pipelaying works

The coarse material that is moved by the works is likely to remain in the vicinity, while the finer sediments will be brought into suspension and thinly dispersed over a wide area (see Section

6.2.2). Therefore, no long-term smothering effects are anticipated from construction works. In addition to the above direct loss and change in habitat type, the infill of different sediments, may result in the poor incubation of spawn by decreasing the oxygen supply or by decreasing the potential of the affected habitat as a spawning ground through smothering. Given the nature of the project it is impossible to avoid construction work during spawning and nursery periods see Table 9.2.

The most marked effects will be in the regions where there will be the removal and replacement of a modest quantity of unconsolidated till material (within the last kilometre of the pipeline) which will affect herring, lemon sole, sole, plaice and shellfish. Regarding shellfish, large numbers of commercially important crustacea are present in the nearshore area (KP 487 to KP 543).

Under such circumstances mortalities can be expected. Previous studies on pipeline dredging works off the Holderness coast have indicated that only approximately 10 % of suspended sediment would remain in the region after 24 hours with the coarser sediments settling out and the finer materials being transported outside the development area by natural processes [ref 10]. However, increased suspended sediment has been raised as an issue by local fishermen and is discussed in section 11. Juvenile lobsters and other crustacea may suffer mortality, directly, or indirectly, through loss of habitat, as a result of smothering. There have been few studies on this topic, but research has shown that the settlement and survival of juvenile lobsters is linked to habitat type [ref 78].

However in all instances, the associated impacts are not expected to be significant as the works will only directly affect each species for part of their spawning/nursing period for one year and are confined to a small area in relation to any entire spawning (see Table 9.3). Direct effects beyond one or two years are considered less probable. Indirect effects relating to the alteration of habitat due to the works will extend beyond this period; however, their magnitude will be significantly less than the initial work.

Pipe-Laying

Finfish and shellfish communities will not be significantly affected by the laying of the pipeline. Temporary minor disturbance or losses may occur to a small number of individuals where the pipeline is laid, notably affecting those species that are unable to avoid the area quickly due to spawning (herring, lemon sole and shellfish) or being in a juvenile state (whiting, lemon sole, sandeels and shellfish), whilst, given the pipeline will be laid at a sufficiently slow rate, any demersal fish and mobile shellfish present will avoid the area, possibly returning to feed on the benthic invertebrates brought to the surface by the disturbance.

Where the pipeline is exposed (mainly up to KP 521) it will act as a new hard substrate across what is mostly a soft sediment seabed. It will bring a localised change in fauna and flora including the potential increase in habitat/population. Video footage taken by Statoil shows high numbers of fish, such as Pollack, sheltering along the existing pipelines. The amount of species able to colonise on, and around, the pipeline are not sufficient to raise concerns about possible large scale structural changes to the seabed communities inhabiting the area.

Table 9.3 Percentage of Total Nursery/Spawning Area Taken by Seabed Intervention Works and Pipelaying

Species	Total Area Taken by Seabed Intervention Works and Pipeline (km ²)	Total Nursery Area (km ²) *	Total Spawning Area (km ²)*	% of Nursery	% of Spawning
Cod	152	295500	129500	0.05	0.12
Herring	218	264000	149500	0.08	0.15
Lemon Sole	750	352000	533000	0.21	0.14
Plaice	13	319500	135000	0.00	0.01
Sandeel	172	261500	265000	0.07	0.06
Sole	38	127500	225000	0.03	0.02
Whiting	522	243500	123000	0.21	0.42

* Total area based on the UK fished waters (North and Irish Sea) approximate.

Anchor Usage

The use of anchors may result in the creation of anchor mounds or scars, the scale and severity of which will vary along the route, depending on sediment type and depth. It is possible that an area of 40 m² may be affected by each anchor drop. Furthermore, the anchor wires may also drag on the seabed and the natural backfilling of finer or disaggregated sediments into the anchor scars may cause localised habitat change. However, the affected areas would be insignificant in comparison to large extents of the existing habitats. As with the intervention works, this activity will result in direct mortality at the anchor point and indirect smothering through sediment dispersion and settlement. However, the areas involved are considerably less than the intervention works.

Anchoring will occur along the whole route except within the last 550 m where the pipeline will be winched ashore; consequently, this will effect all spawning and nursery grounds listed above. However, it will be limited to pipelaying operations. Post construction, the duration over which the effects persist will depend on the underlying sedimentology. In fine substrate and coarse unconsolidated sediment areas the mounds/scars will disappear within a few months and in clay areas they may remain for a longer period.

Rock Dumping and Mattress Placement

The areas subjected to rock dumping will suffer small-scale disturbance, direct mortality, loss of original habitat and creation of alternative habitat due to the addition of a hard substrate. The preparatory work for all the crossings will commence in February 2005 and be completed by March of that same year. This activity will be kept to a minimum and will only occur in areas that require the additional materials for safety reasons. These preparatory activities will coincide with the spawning periods for cod and sole; in addition to the juvenile nursery period for sandeel and plaice, making the timing of this activity less sensitive than the pipelaying and intervention works. Finfish will actively avoid the areas of disturbance.

Rock dumping and mattress placement at the Cleeton Pipeline crossing (KP 537) and the nearshore/offshore connection point (KP 528) will cause some effects on commercially important shellfish and their habitats as well as the demersal spawning grounds. However, these works are occurring outside of peak spawning periods with the exception of the edible crab. However, only minimal effects are expected from the rock dumping and mattress placement. The main area of concern is in nearshore waters, where the wide variety of sediments provide

habitat for a wider range of species, including the more fragile sessile invertebrates and commercially important shellfish.

Nonetheless, the area of activity will be considerably less than that of the seabed intervention works and in all instances works will only affect each species for part of their spawning/nursing period for one year and are confined to a small area in relation to the entire ground.

Cofferdam Construction and Floating Channel

The work from KP 542 –KP 543 will be undertaken in the period April to June 2005. During construction the upper seabed layers will be removed, reworked and replaced in a disaggregated manner. This will affect those species that have spawning and nursery areas in the region, namely herring, lemon sole, and plaice; in addition to the large numbers of commercially important crustacea. The release of suspended sediments outside the construction work area, in shallower waters may smother these species. The smothering potential will be more marked in the region to the south of the works where the excavated sediments are to be temporarily stored. Impacts within this area are potentially more significant given the work will occur over a more prolonged period and affect the whole spawning period of the sole for one year. Nonetheless, these works are confined to a small area in relation to the entire ground with sea condition rapidly re-dispersing any smothering sediments.

Discharge of the Flush Water

The flush water will be discharged to sea through a dedicated discharge pipeline. The flush water will be deoxygenated and may contain residual trace oxygen scavenger. It could; therefore, have a limited effect on shellfish immediately within the discharge zone. The total discharge rate (up to 1,600 m³/hr) will have a transient localised effect on the ambient sea water quality and may result in some erosion of the seabed directly in its path. This has the potential to cause some direct affects on demersal species/spawners. The area of influence would; however, be limited to the immediate proximity of the discharge point and the effects are considered negligible.

9.3.2 Operation

No significant operational phase impacts are anticipated. In the demersal spawning grounds, localised scour may reduce suitable habitat conditions; however, this will only be of relevance in the immediate proximity of the pipeline. Consequently, the area affected will be insignificant when compared to overall spawning populations.

10 MARINE MAMMALS

Cetacean species of interest are listed in Annex IV of the Habitats Directive [ref 26]. The Directive states that the “*keeping, deliberate capture, killing, disturbance, sale or exchange of such species is banned in UK waters*” [ref 26].

The harbour porpoise, bottlenose dolphin and grey and harbour seals are also listed in the Annex II of the Habitats Directive. Member states are required to consider establishing SAC for these species, and two candidate SACs have been defined for the bottlenose dolphin in the Moray Firth and in Cardigan Bay. No candidate SACs have yet been established for the harbour porpoise or the grey or harbour seal [ref 26].

10.1 Methodology

The information for the marine mammals used in this Chapter has been obtained from the following sources: [ref 3, 26, 27, 100, and 111].

An assessment of potential impacts on marine mammals resulted in the following definitions.

Significant	Permanent avoidance of area and/or mortality of individuals due to associated impacts from construction works.
Moderate / Low	Short term (during construction period) avoidance of the area, but no injury or mortality to individuals, fast recovery (within 1 year) of individuals to the area.
Negligible	Animals observed in the area and not exhibiting signs of distress.

10.2 Baseline Environment

10.2.1 Occurrence

There are eight mammal species that occur regularly in large parts of the North Sea [ref 27]:

- grey seal (*Halichoerus grypus*);
- harbour or common seal (*Phoca vitulina*);
- harbour porpoise (*Phocoena phocoena*);
- bottlenose dolphin (*Tursiops truncatus*);
- Atlantic white-sided dolphin (*Lagenorhynchus acutus*);
- killer whale (*Orcinus orca*); and
- minke whale (*Balaenoptera acutorostrata*).

The exception is the white-beaked dolphin where there is some seasonal aggregation around the north-east English coast during April-to-June. Regarding seals, there are no identified haul-out sites along the extent of the Holderness coast [ref 27]. Similarly, there are no known pup-rearing areas within this area.

10.3 Assessment of Impacts

10.3.1 Noise and Vibration

The risks to marine mammals from anthropogenic noise and vibration are well documented [ref 26] and principally relate to very low frequency and loud emissions. It is reported that, regarding vessel noise, “frequencies range from 10 Hz-to-10 kHz, whilst source levels and dominant frequencies, range from 152 dB at 6300 Hz through to 162 dB at 630 Hz for a tug/barge travelling at 1 km/hr to a large tanker (lay barge) with source level around 177 dB in the 100 Hz third-octave band” [ref 116].

The underwater noise organisation (UNO) reiterate this through stating that: “the source levels associated with low-frequency pure tones radiated by super tankers and container ships lies in the range 180-190 dB (reference 1 µPa at one-metre), while drill-ship and dredging operations generate broadband source levels of 185 dB (reference 1 µPa per Hz at one-metre) [ref 101]”.

The effective construction area will be continually moving; therefore, noise and vibration impacts at any single point will be transient. They will; however, be greater, and take place for a longer time in the nearshore waters because of the pre-lay dredging and back filling that will take place in this sector of the route. The only static area of construction is associated with the beach works and cofferdam. The main source of noise and vibration relating to these construction activities will be pile driving.

Cetaceans occur regularly over the entire pipeline route. However, no sensitive or significant populations have been identified in the baseline assessment discussed above. Despite concerns about interference with their hearing and communication leading to behavioural changes, it is likely that any marine mammals in the vicinity of the beach and nearshore construction works will simply avoid the area during periods of high noise, especially during the periods of intense emissions from pile-driving [ref 101].

The potential impacts are; therefore, limited to those from the vessels working in the comparatively quieter offshore sector, where there remains a risk of masking the cetacean’s ability to detect a sound signal due to the frequency (tone) of the noise source. Relatively low levels of noise will be produced by the anchor tugs and support vessels. The lay barge will produce some noise during the pipe welding and laying activity. However, any such effects from vessels will be short-term and are not likely to have significant effects on individuals. Further potential for noise will occur close to the regions where rock dumping will occur.

Little is presently understood of the noise associated with rock dumping. One main source; however, is a report undertaken by BP [ref 11], which assessed the effects of noise on various species. It concluded the following:

- for all species considered there was a contribution to the perceived noise level³¹;
- noise propagation in deep water is the more efficient than shallow, with the result that the perceived noise dominated a greater range;
- the perceived noise level varied from vessel-to-vessel; for instance a rock dumping vessel was noisier than others; and

³¹ In relation to dBht for species.

- there was a notable species-specific dependence on parameters of the noise such as the perceived noise levels, transmission loss etc.

However, the noise from rock dumping is short-term and transient, and despite this activity occurring at depth where there is less attenuation, levels are not expected to exceed local ambient levels beyond a few kilometres. Impact potential is further reduced given that the timing of the rock-dumping (March and September/October 2005) is outside the peak period for cetacean presence (June – September). Therefore, despite the concerns of noise affecting hearing ability interfering with communication and leading to behavioural changes, principally in marine mammals, it is considered likely that any animals that remain in the vicinity during the period of the works would show avoidance behaviour at times of increased noise.

11 FISHERIES

The fishing industry in the North Sea is categorised by the species caught, i.e. demersal, pelagic and/or industrial.

Demersal fishing targets those species that live on, or near, the seabed. Due to the high variety of demersal species in the North Sea, vessels are unable to target a single specific fish type. Catches; therefore, often comprise a wide range of species. The most commonly caught species are the round and flat fish such as cod, haddock, whiting, monkfish, plaice, sole, and lemon sole. Demersal fishing also targets shellfish, such as shrimp, scallop, lobster, prawns and crab. The principal methods for catching demersal species are by trawled-gear Scottish seining and potting.

Pelagic fishing targets those species that exist in the water-column. The fleets of fishing vessels commonly occupy UKCS waters where water depths range between 20 to 400 m as these are areas of high primary productivity (FRS, 2003). Pelagic species tend to be migratory in nature; therefore, fishing efforts target large areas depending on fish movements. The most commonly caught pelagic species in the North Sea are herring and mackerel. Techniques employed to maximise the catch are mid-water trawling (both pair and single forms).

Industrial fishing is a large-scale operation targeting species that can be used for purposes such as fish meal and fish oil these include; Norway pout, sandeel, and sprat. These fish are caught using small-meshed trawl gear (FRS, 2003).

11.1 Methodology

The fishing industry will be impacted by the proposed development, due to the size of the pipeline and magnitude of the project. The information gathered has, therefore, not only been derived from following general sources [refs 26, 27 and 111], statistical data on catch and effort from DEFRA (Fisheries Statistics Unit - FSU) and SEERAD (Scottish Executive Environment and Rural Affairs Department) Scottish Fisheries Statistics (SFS), and [ref 3], but has also been generated from primary data from local sources. This is of particular importance in the nearshore environment where knowledge of the specific static gear fishing movements has great relevance to this project. DanBrit Ship Management were responsible for compiling much of this local data. It should be noted that the fishing data on vessel activity from the FSU and SFS relate to vessels ranging between 10 and 17 m in length. Data have also been obtained from DEFRA for the larger fishing vessels (greater than 24 m in length) operating along the pipeline route. These vessel sizes cover the significant majority of vessels found within the UKCS. However, these data do not fully encompass all the fishing activity (for instance there will be smaller boats working in the inshore waters). Therefore, to provide a more comprehensive coverage on fishing activity in the inshore waters data were obtained from the North Eastern Sea Fisheries Committee (NESFC).

Specific data references are:

- summary of fishing effort 2002 and 2003 (NESFC);
- shellfish landing statistics 2002 and 2003 (NESFC); and
- fishing activity and methods along the pipeline and provision of potting movements for one boat off the Easington coast (DanBrit Ship Management Ltd, (Consultations 2003)).

Consultations were held with the Scottish Fisheries Federation (SFF), the National Federation of Fishermen's Organisations (NFFO), North Eastern Sea Fisheries Committee (NESFC) and the regional DEFRA representative. All these organisations have provided useful information on catch species and the important seasonal periods in addition to addressing issues relating to pipeline development. Their concerns have been taken on board by the development team and addressed in this assessment.

An assessment of impact significance based on the magnitude and permanency of loss or income both directly or indirectly culminated in the following definitions. The main factors considered were:

- loss of access to traditional fishing areas
- reduction in the quality or quantity of catches
- the durations of these impacts

Significant Sustained (greater than 1 year) or permanent loss of income for 1 or more fishermen

Moderate Total loss in income for 1 or more fishermen for a considerable period (greater than 1 month)

Low Small scale decline in income for 1 or more fishermen during the work period, with recovery in earnings occurring immediate to cessation of obstructing work

11.2 Baseline Environment

Fishing statistics for 2002 have been gathered from the FSU and SFS, detailing the fishing effort (in days fished) and species landed (dry weight) for the ICES Blocks through which the pipeline runs. This only covers data from vessels that land at Scottish and English ports. A summary of the fishing gear used by the vessels is given below (for Scottish and English vessels in 2002):

- trawl (standard beam, pair/twin, otter - including all types of bottom single otter trawling - mid otter, nephrops and other);
- seine (Scottish, pair and Danish anchor);
- set gill nets (anchored); and
- long lines.

Fishing effort along the pipeline by vessels operating out of Scottish and English ports can be seen in Figure 11.2. Scottish fishing activity within the ICES Blocks along the pipeline route is consistently higher than English, with the former totalling 3446 days fished and the latter 899 days. Table 11.1 summarises the combined fishing information for the ICES Blocks through which the pipeline passes.

Table 11.1 : Combined Fishing Activity for offshore Scottish and English Vessels (10-17 m in length) for 2002

ICES Block	Cumulative days fished in 2002	Percentage of fishing techniques (%)	Fishing Effort	Key species caught & weight landed (tonnes)	Fishing notes
36F0	299.2	Beam trawl.....93.7 Otter trawl.....4.95 Pair trawl.....0 Mid water trawl.....0 Seining.....0 Nephrops trawl.....1.1 Other.....0.25	Low	Edible crab.....1075 Whelk.....887 Brown shrimp.....141 Scallop.....62 Lobster.....62	Standard Beam trawling accounted for the majority of the fishing methods. A small amount of Otter trawling took place in January, February, June, July, October and November. A small amount of Nephrops trawling was undertaken in October. Fishing activity peaked between November and March and was almost non-existent during June and July. Crabs (the edible crab, <i>Cancer pagurus</i>) and whelks (<i>Buccinum</i> sp) dominated the six types of shellfish caught. Other shellfish species caught were brown shrimps (<i>Crangon crangon</i>), scallops, lobsters, and velvet crabs (<i>Liocarcinus puber</i>). The main fish species caught were the demersal species: plaice (<i>Pleuronectes platessa</i>); cod (<i>Gadus morhua</i>); sole (<i>Solea solea</i>); and whiting (<i>Merlangius merlangus</i>). Note: small inshore potting vessel activity is not included in this section but discussed in detail in the inshore waters section
37F0	960.2	Beam trawl.....5 Otter trawl.....42.3 Pair trawl.....52.5 Mid water trawl.....0 Seining.....0 Nephrops trawl.....0 Other.....0.27	High	Haddock.....374 Cod.....234 Whelk.....215 Edible crab.....177 Scallop.....117	The majority of the fishing activity was by Pair trawling and Otter trawling. Standard Beam trawling occurred for a few days during the winter months. The only other fishing method undertaken was Long lining (in July and September). Fishing activity peaked during late summer and autumn and was at it lowest during spring. The catch was dominated by demersal fish and shellfish. Haddock, cod, whelks, edible crabs, scallops and whiting were heavily caught. The remaining principal species caught were comprised of demersal species such as plaice, lemon sole (<i>Microstomus kitt</i>), skates, rays and squid (<i>Alloteuthis</i> spp).

ICES Block	Cumulative days fished in 2002	Percentage of fishing techniques (%)	Fishing Effort	Key species caught & weight landed (tonnes)	Fishing notes
38F0	321.2	Beam trawl.....8.8 Otter trawl.....51.7 Pair trawl.....32.9 Mid water trawl.....2.2 Seining.....1.4 Nephrops trawl.....3 Other.....0	Very Low	Sandeels.....190 Haddock.....58 Cod.....230 Plaice.....23 Whiting.....13	A large variety of fishing methods were used in this area throughout the year. Pair trawling was the intense method during summer and autumn. Otter trawling peaked during spring and late summer to autumn. Standard Beam trawling occurred during autumn and early winter, Nephrops trawling in May and November, Mid Otter trawls in June and a few days of Scottish seining in October and November. Fishing activity peaked in May and then again during late summer and autumn. Demersal fish species dominated the species caught; sandeels, haddock and cod also comprised a significant amount to the total weight of main species caught. Six other demersal species (plaice, whiting, spurdog (<i>Squalus acanthias</i>), lemon sole, red gurnards (<i>Aspitrigla cuculus</i>) and dab (<i>Limanda limanda</i>)) were also caught.
39F0	334.1	Beam trawl.....0.5 Otter trawl.....74.4 Pair trawl.....8.9 Mid water trawl.....1.3 Seining.....2 Nephrops trawl.....12.8 Other.....0	Low	Haddock.....147 Whiting.....41 Nephrops.....36 Red Gurnard.....23 Lemon sole.....15	Otter trawling formed the bulk of the fishing methods, especially during spring and late summer and autumn. Pair/Twin Otter trawling was common during late summer and autumn. Nephrops Otter trawling occurred during spring and autumn, whilst Pair trawling was largely restricted to the summer and autumn months. A very small amount of Danish anchor seining occurred in November. No fishing activity occurred during July. During the peak activity in August a total of 45 days were fished in the area. Demersal fish species again dominated the main species caught. Haddock, whiting, nephrops, red gurnard, lemon sole, plaice, cod, spurdog, red mullet (<i>Mullus surmuletus</i>) and squid were all caught in significant amounts.
40F0	156.7	Beam trawl.....4.2 Otter trawl.....57.1 Pair trawl.....31.3 Mid water trawl.....0 Seining.....5 Nephrops trawl.....2.4 Other.....0	Very Low	Haddock.....90 Nephrops.....23 Plaice.....19 Whiting.....12 Lemon sole.....10	The cumulative number of days fished in a month did not exceed 20. Pair/Twin trawling and Otter trawling are the two most common fishing methods. Twin Otter trawling, Standard Beam trawling, Scottish seining (February, March, May and September) and Nephrops trawling (September, October and December) also occur. Fishing activity peaked during April, June and late summer through to early winter. Haddock, nephrops, plaice, whiting, lemon sole, squid, red gurnard, cod, spurdog, and anglerfish (monks, <i>Lophius piscatorius</i> and <i>Lophius budegassa</i>) comprised the main species caught.

ICES Block	Cumulative days fished in 2002	Percentage of fishing techniques (%)	Fishing Effort	Key species caught & weight landed (tonnes)	Fishing notes
40F1	64.4	Beam trawl.....14.5 Otter trawl.....42 Pair trawl.....38.8 Mid water trawl.....0 Seining.....4.7 Nephrops trawl.....0 Other.....0	Very Low	Haddock.....27 Plaice.....21 Lemon sole.....13 Red Gurnard.....10 Squid.....5	Levels of fishing activity peaked at 25 days during May. Pair trawling and Otter trawling formed the majority of the fishing methods applied. Standard Beam trawling occurred in small amounts during May, June, August and November. Scottish seining occurred for a day in April, June and October. The months of January, February, July, and September saw no fishing activity occurring. Demersal fish species comprise the main catch, along with Squid. A similar species catch composition to Blocks 39F0 and 40F0 is seen, with the exception of there being no shellfish caught in significant amounts.
41F0	157.7	Beam trawl.....0 Otter trawl.....62.6 Pair trawl.....20.3 Mid water trawl.....0 Seining.....14.6 Nephrops trawl.....0 Other.....2.5	Very Low	Haddock.....108 Whiting.....28 Nephrops.....28 Cod.....10 Lemon sole.....7	Only four different fishing techniques were used; Scottish seining, Otter trawling, Pair trawling and Set gill netting. Effort peaked in January and March. Summer through to winter saw the lowest levels of activity in this area. Demersal fish species and the Norway lobster dominated the main species caught. In addition to the usual demersal species caught, saithe (or Coalfish) (<i>Lophius budegassa</i>) and turbot (<i>Psetta maxima</i>) also formed part of the main catch.
41F1	59.8	Beam trawl.....0 Otter trawl.....59.9 Pair trawl.....36.8 Mid water trawl.....0 Seining.....3.3 Nephrops trawl.....0 Other.....0	Very Low	Haddock.....25 Nephrops.....14 Red Gurnard.....5 Squids.....5 Lemon sole.....5	Fishing activity peaked in April and May. Pair/Twin trawling, Otter trawling and Scottish seining (March and August) were the only fishing techniques applied. No fishing activity occurred during June, July and October. Haddock and Nephrops again comprise the bulk of species caught. The other species which were caught in significant amounts were all demersal fish (which included witches (<i>Glyptocephalus cynoglossus</i>)) and squid.
42F0	892	Beam trawl.....0.3 Otter trawl.....89.2 Pair trawl.....4.3 Mid water trawl.....0.4 Seining.....3.3	High	Nephrops.....253 Haddock.....140 Whiting.....106 Anglerfish (monks).....59	Peak activity occurred in the late summer (around 125 days being fished in September). Otter trawling and Pair/Twin Otter trawling formed the majority of the fishing methods undertaken in this Block. A small amount of Scottish seining (from January to July), and Standard Beam trawling (from June to July) took place. Boat dredging was also undertaken for 20 days in September and 2 days in October.

ICES Block	Cumulative days fished in 2002	Percentage of fishing techniques (%)	Fishing Effort	Key species caught & weight landed (tonnes)	Fishing notes
		Nephrops trawl.....0 Other.....2.5		Lemon sole.....41	Nephrops, haddock and whiting contributed significantly to the total weight caught. Other demersal species caught included anglerfish (monks), lemon sole, cod, plaice and witches. One pelagic fish (herring (<i>Clupea harengus</i>)) was caught in significant amounts and one shellfish (scallops) was caught.
42F1	182.8	Beam trawl.....0.6 Otter trawl.....83 Pair trawl.....7.7 Mid water trawl.....4.3 Seining.....4.4 Nephrops trawl.....0 Other.....0	Very Low	Herring.....47 Anglerfish (monks).....26 Lemon sole.....25 Nephrops.....23 Haddock.....21	Activity remained below 20 days per month with the exception of April, which saw around 30 days and May, which totalled over 65 days fished. Otter trawling formed the main component of the fishing methods. Pair seining with two vessels, Pair/Twin Otter trawling, and Scottish seining were also undertaken, mainly during April and May. Herring, a pelagic fish species was the dominant species caught. However, this was the only pelagic species caught in any significant amounts. The remainder of the catch was comprised of demersal species, similar to other Blocks, and the Norway lobster.
43F1	176.3	Beam trawl.....1.1 Otter trawl.....21.6 Pair trawl.....27.2 Mid water trawl...17.8 Seining.....31.7 Nephrops trawl.....0 Other.....0.6	Very Low	Herring.....338 Haddock.....74 Lemon sole.....35 Plaice.....22 Witches.....19	Activity was highest during spring and early summer, with a peak in May when fishing activity totalled around 55 days. There was a high variety of fishing methods used over the year, pair/twin trawling and Scottish seining were most common. Otter trawling, pair seining with two vessels, set gill netting, mid Otter trawling and standard Beam trawling were other methods practiced. No fishing activity occurred during February and December. Herring was the main species caught. Demersal species comprised the remainder of the significant catch. No shellfish were caught in any significant amounts.
44F1	307.2	Beam trawl.....0 Otter trawl.....62.3 Pair trawl.....17.4 Mid water trawl.....0.3 Seining.....8.1 Nephrops trawl...11.9 Other.....0	Low	Haddock.....120 Nephrops.....83 Herring.....34 Plaice.....24 Cod.....22	The fishing activity peaked during September (a total in excess 100 days were fished). As with its neighbouring Block, a wide variety of fishing methods were employed, with Otter trawling being the most commonly practiced. Pair/Twin trawling was undertaken over the spring and summer months (peaking in June), Nephrops Otter trawling occurred from January to April, and August to October. Both Scottish seining and Pair seining (two vessels) were also practiced. The month of December remained un-fished. Haddock and Norway lobster formed the majority of the main catch. The remainder was made up of herring and demersal species. No shellfish were caught in significant amounts.

ICES Block	Cumulative days fished in 2002	Percentage of fishing techniques (%)	Fishing Effort	Key species caught & weight landed (tonnes)	Fishing notes
45F1	1333.3	Beam trawl.....0 Otter trawl.....71.4 Pair trawl.....4.2 Mid water trawl.....2.7 Seining.....0.7 Nephrops trawl.....21 Other.....0	Very High	Herring.....1874 Nephrops.....519 Haddock.....230 Anglerfish (monks)....110 Cod.....103	Exceptional levels of fishing activity took place in September (a cumulative total of over 400 days). Otter trawling was the most dominant fishing method undertaken. Nephrops trawling was very high in April, August and September, small amount were also undertaken in October and November. Mid water trawling was high for the month of May. Other methods used were with two vessels, Pair/Twin Otter trawling, Pair seining and Scottish seining. No fishing activity occurred in May. Herring and the shellfish Nephrops were the most abundant species caught, the remainder of the principal catch was made up from demersal fish species.
TOTAL	5244.9	Beam trawl.....7.2 Otter trawl.....61.3 Pair trawl.....18.6 Mid water trawl.....1.1 Seining.....4 Nephrops trawl.....7.2 Other.....0.6		Herring.....2293 Haddock.....1414 Edible crab.....1252 Whelk.....1102 Nephrops.....960	

Trawling

Trawling in the North Sea is not noted for its overall high intensity but there are numerous areas in the vicinity of the pipeline route that are significant trawling grounds. In the north, prawn trawlers often work in the Forties area some distance north west of the pipeline at KP 23. (see Figure 11.1). The first important offshore fishing area is the Devil's Hole (KP 168 to KP 226). The next important trawling area is Brucey's Garden (KP 408 to KP 428) (see Figure 11.1), which is a major trawling ground, as it is an area of hard sediment. In addition trawling occurs around existing oil and gas pipelines. These are mainly trawled by vessels from Aberdeen, Peterhead and Fraserburgh. Closer to the UK coast are the important areas to the north-east of the pipeline off Flamborough Head. This is the *Flamborough Head Ground* where trawling occurs out to 18 nm from the coast east of the pipeline route. The UK vessels operating in the *Flamborough Head Ground* area are mainly from Scarborough and Whitby. Especially high fishing effort occurs from July-to-September when vessels that target pelagic species are fishing for herring and mackerel.

Although UK trawlers are permitted to fish between 6-12 nm (KP 531 to KP 517) off the coast only a minority do so due to the legal restriction placed on the area. Beam trawling inshore is restricted by EC legislation and regulated by DEFRA. The restrictions stipulate that mesh size should be greater than 80mm.

- the aggregate beam is less than 9 m;
- their engine power is less than 221 kW; and
- the vessels do not exceed 24 m in length (DEFRA, 2002).

Locally, bylaws set by the NESFC dictate that no trawling can occur within three nautical miles from the coast between Flamborough Head Witter Hole to Spurn Head. This prohibited trawl zone has been generated in order to avoid confrontation with the static-gear for potting and netting, and to protect juvenile species, which use the area as a nursery ground. Within the NESFC district the maximum size for trawlers is 18.3 m, subject to a restricted sunset list (6 vessels - 2003). In addition, no vessels greater than 16 m in length can fish for shellfish inside of six nautical miles from the coast. One other consideration in the region is a small-scale brown and pink shrimp beam-trawl fishery that lay up to 1 nm (KP 542) offshore between the Humber Estuary and The Wash [ref 47].

Static Gear

Shellfish spawn generally between May and June (NESFC) and are likely to include molluscs (scallops and whelks) and decapods (shrimps, prawns, lobsters and crabs) and are discussed below. Potting for shellfish occurs throughout the summer, which is when the peak fishing season occurs in terms of quantities landed. According to the data for 2002, the species most commonly caught by Scottish and English vessels include:

- Norway lobster (*Nephrops norvegicus*);
- edible crab (*Cancer pagurus*);
- European lobster (*Homarus gammarus*);
- king scallop (*Pecten maximus*);
- whelk (*Buccinum undatum*);
- velvet crab (*Necora puber*); and,
- brown shrimp (*Crangon crangon*).

Pink shrimp (*Pandalus montagui*), Atlantic prawn (*Pandalus borealis*) and the deep water shrimp (*Aristaeomorpha foliacea*) are also commercially fished in this region. The inshore waters in the Easington area are where the majority of static gear fishing takes place along the pipeline route and as such it supports a variety of fishing practices. The area is very heavily fished and is particularly important in the North Sea for crab and lobster. Within the six nautical miles (KP 531), static-gear fishing (nets and pots) dominates fishing practices. The effort tends to be concentrated around wrecks, rocks, pipelines and other areas of hard substrata, where their target species congregate.

One such area, which has been identified by the NESFC (and shown in Figure 11.1), is a stretch of clay hummocks, known locally as 'clay huts', which is a structure that supports significant numbers of lobsters. This clay habitat has many natural holes within its structure, which according to local information, support particularly high numbers of lobsters (NESFC, personal communications, 2004). Consequently, this stretch is very heavily fished. The peak fishing time is between July and August with efforts focusing on the new shell lobsters that are found at their highest intensity from 6 nm up to MLW (KP 531 to KP 543). Table 11.2 (overleaf) provides a summary of the static-gear fishing activity in 2002 and 2003 off the Holderness coast between Flamborough Head and Grimsby.

The majority of the *potting* activity takes place as far out as 43 km off Flamborough Head, 40 km off Spurn Head and to the far extent of the Rough Gas Field (approximately 31 km from Easington). Some potting activity does extend out past the Silver Pit [ref 27], but trawling is also practised with larger vessels (notably Dutch and Belgian beam trawling). However, it is only a minority of the potting vessels that work greater than 12 nm offshore (KP 517). Potting is undertaken 90% of the year close to the Holderness coast; but, becomes very intense from late March through to late September/early October. After this period the crabs and lobsters tend to move further offshore into deeper waters. Lobsters prices can vary from £9.00/kg in the summer and £17.00/kg in the winter, and this high value can lead to extremely intense potting in the proposed development area during late July through to October, when the lobster are most easily caught. The peak fishing period for edible crab is from the end of March to the middle of May, with a secondary peak from August. This secondary peak in crab catches may be due to the increased number of pots in the area (as a result of the lobster fishing) causing an increase in numbers of crabs caught, rather than to any seasonal change in crab densities. Crab caught in the area fetch in the region of £0.90-to-£1.10/kg, which represents a far less important source of income than lobster. However, much more crab is landed and the ratio of lobster-to-crab catch is around 30:70. In recent years there has been a rapid expansion in velvet crab fishing off the Holderness coastline, as result of increasing markets and transportation infrastructure. Catches in 2001 and 2002 were 154 and 270 tonnes respectively, and this figure is likely to have increased in 2003. The average prices for Velvet Crab range between £0.80/kg to £2.10/kg. The price depends on the size, quality and demand.

Table 11.2 Fishing Summary for Inshore Vessels Operating out of Ports on the Holderness Coast in 2002 and 2003

Port Location	Fishing Details 2002	Fishing Details 2003
Bridlington	Number of vessels: 40 Potting: 38,500 pots Netting: 128,000 metres Trawling: Vessels based in Scarborough	Number of vessels: 40 Potting: 38,550 pots Netting: 128,000 metres Trawling: Vessels based in Scarborough
Hornsea	Number of vessels: 8 Potting: 4,500 pots Netting: 500 metres	Number of vessels: 6 Potting: 3,000 pots Netting: 500 metres
Tunstall	Number of vessels: 5 Potting: 2250 pots, Netting: 2171 metres	Number of vessels: 3 Potting: 1,000 pots Netting: 0
Withernsea	Number of vessels: 9 Potting: 1,980 pots, Netting: 1,200 metres	Number of vessels: 8 Potting: 1,700 pots Netting: 1,200 metres
Easington	Number of vessels: 6 Potting: 1,990 pots,	Number of vessels: 5 Potting: 2,010 pots
Spurn Head Point	Number of vessels: 6 Potting: 600 pots	Number of vessels: 2 Potting: 850 pots
Hull	Number of vessels: 1 Potting: 450 pots	Number of vessels: 1 Potting: 450 pots
Grimsby	Number of vessels: 12 Potting: 3,150 pots Netting: 13,100 metres Trawling: 8 boats Beam trawling: 14 mid water	Number of vessels: 6 Potting: 3,150 pots Netting: 13,100 metres Trawling: 6 boats Beam trawling: 14 mid water

Note: The above vessels numbers for 2002 and 2003 do not take unlicensed vessels into account.

Source: North Eastern Sea Fisheries Committee (NESFC), Danbrit Ship Management

Large potting vessels from Grimsby and the Channel Islands are also known to work off the Flamborough and Spurn Head regions. Figure 11.4 shows the movements of a *single* potting vessel that operated off the Holderness coast over the period of one year in 2002. It is clear that the fishing effort follows the movements of the shellfish throughout the year. Further, it also identifies that potting activity peaks during the middle-to-late summer months. A summary of the total kilograms of shellfish landed in 2002 from vessels operating off this stretch of coastline is provided below.

Table 11.3 Summary of Potting Catches (2002)

PORT	Lobster (Kg)	Edible crab (Kg)	Velvet crab (Kg)	Whelk (Kg)
Bridlington	164,842.5	849,703.3	185,710.8	558.3
Offshore Bridlington	69,009	688,823.1	130,587.5	361.7
Hornsea	16,006.5	32,161.5	297.3	0
Tunstall	5,965	22,554.1	15	0
Withernsea	6,444	14,452.9	15	0
Hull	44,922.3	29,882	1,345	12.5
Grimsby	5,979	121,814	0	0
Total	313,260	1,759,391	317,971	932

Although *netting* occurs throughout the year the majority of catches are taken between August and December with the peak period occurring between November and December (NESFC). The latter relates to the increased popularity of sea bass, *Dicentrachus labrax*, from inshore netting along the Holderness coastline. Further instances of netting principally target sole (nearshore March to June) and cod (around rocks, pipelines and wrecks November to February). These nets are around 250 m in length. The larger vessels have up to 10 fleets of netting with each of these netting fleets being between 100 to 600 m. More importantly the vessels are likely to have around 1,500 to 3,000 m of net deployed at any one time during the winter months. However, fishing intensity is kept low by the poor weather conditions and extreme tidal movements [ref 47].

11.3 Assessment of Impacts

The main potential impacts from the pipeline on the fishing industry relate to: spanning and the exclusion zones, particularly in the nearshore area (0 – 6 nm) and the indirect effects from habitat removal, disturbance, and smothering are; based on the conclusions on the previous chapters, considered to be low. These are described in more detail below. The periods of potential interaction with fishing activity are shown in Table 11.4.

11.3.1 Construction

Seabed Intervention Works

Where static gear is deployed, mainly between KP 517 and the shore, the fishermen operating in the area have raised concerns relating to the effects of increased turbidity from pipeline developments and their effects on shellfish. The sediments disturbed by the intervention works will comprise the coarser surficial sediments (gravel, coarse sand, cobbles and boulders) and the underlying sediments (which include clays and silts). The majority of the sediments disturbed will be of sufficient density that they will settle out immediately. However, the clay and silt particles may be moved by the currents prior to settling out, the result of which could result in a smothering effect on surrounding areas. This is confirmed through the BP Amoco studies on the trenching of a 26” pipeline in the area [ref 10], which suggests that the turbidity would mimic a prolonged winter storm scenario. Their studies showed that less than 10% of suspended sediment would remain in the region after 24 hours with the coarser sediments settling out and the finer materials being transported outside the development area by natural processes (as confirmed below). Sediment deposition was anticipated to be 1 mm in the vicinity of the

pipeline decreasing to 0.1 mm over a 2 km area. This is only likely to be sufficient to locally disrupt juvenile crab and lobster and natural strong currents are expected to quickly redistribute these sediments [ref 10].





Table 11.4 Peak Fishing Activities that Coincide with Seabed Intervention Work/Pipelaying

General KP Points	KP Points	J	F	M	A	M	J	J	A	S	O	N	D	
KP 23 - KP 520s	Activity/Period													
	Spot post-lay trenching	23 -451												
	Post-Lay Trenching	451 - 521												
	Pre-lay sweeping	451 - 521												
	LB 200 Pipelaying	23 - 360												
	LB 200 Pipelaying	360 - 410												
	LB 200 Pipelaying	410 - 528												
	Fishing Activity													
	Trawling in the Forties	23									*			
	Trawling Devil's Hole	168 -226									*			
Trawling Brucey's Garden	408 - 428									# *				
KP 520s - KP 543	Activity/Period													
	Pre-Dredging	521 - 550 m from MLW												
	Cofferdam Construction & Excavation Period	90 m to MLW												
	Floating Channel Excavation Window	550 m - 90 m from MLW												
	Pipeline Pull In Window	542 - 543												
	Floating Channel Backfilling and Cofferdam Removal Window	542 - 543												
	Tog Mor Pipelaying	528 - 542												
	Fishing Activity													
	Potting	517 - 543			*	*	# *	# *	#*	# *				
	Netting	517 - 543								# *				
Clay Hut	542 -543					# *	# *	*	*					

* - Interaction fishing activity and intervention works; and # - Interaction between fishing activity and pipelaying works

Figure 11.1.
Intense Fishing Grounds
for Vessels Greater than
24 m in length

Legend

-  Transboundary line
-  Southern pipeline system
-  Land
-  Intense fishing areas (by vessels >24m)
-  ICES Blocks

Note: The fishing activity, supplied by DEFRA, from satellite recordings relates only to vessels > 24 m in length

© Metoc plc, Data Licence 052003.005. All Rights Reserved.



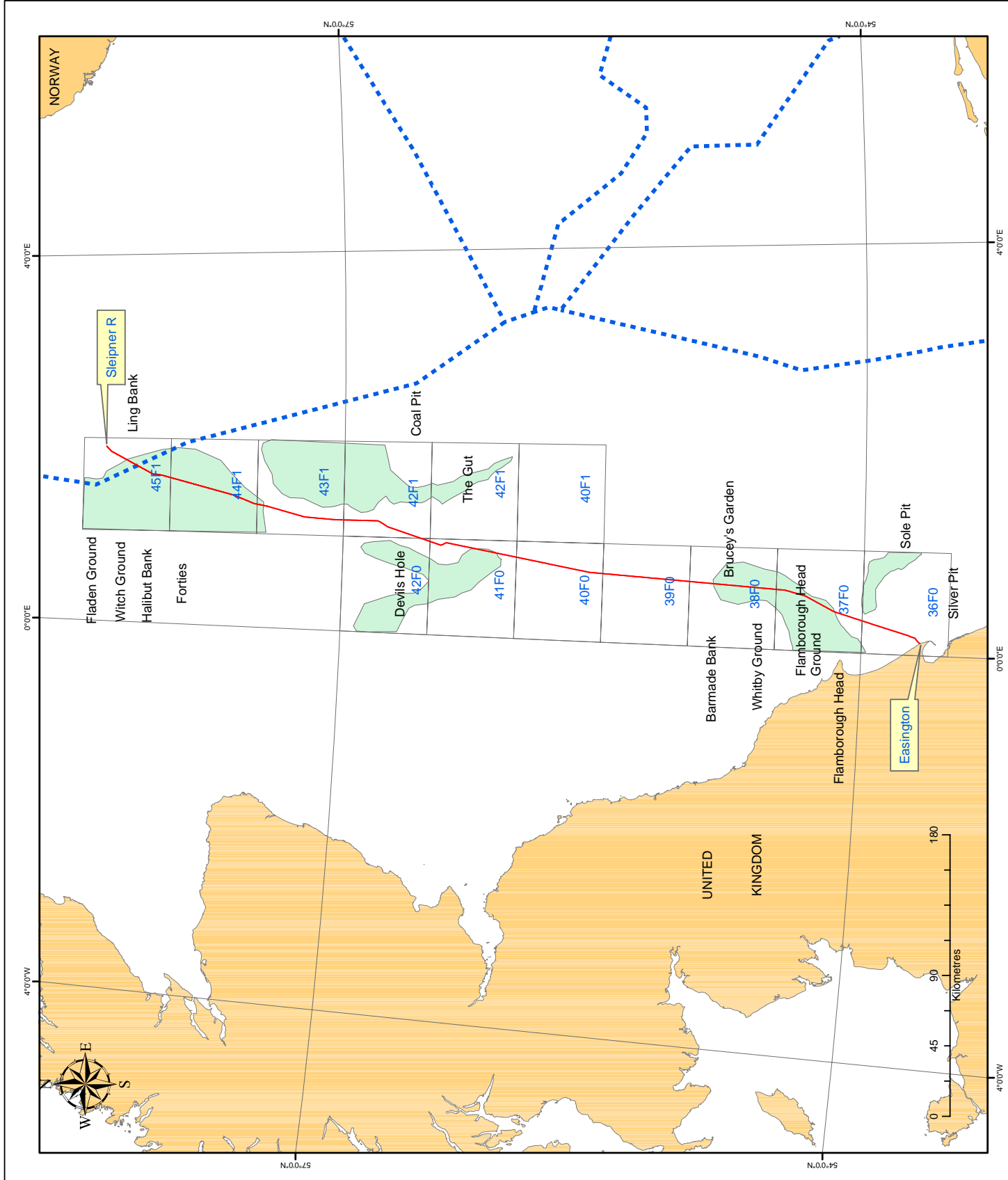

NOT TO BE USED FOR NAVIGATION

Date	24/January/2004
Projection	UTM Zone 31N
Spheroid	International 1924
Datum	ED 50
Data Source	Metoc Charts, SFS, FSU
File Reference	I:_P517\GIS\AvProj\P517-Sat_24mvessels.mxd
Checked	Jillian Barnes
	Philip Wemyss
	GIS Specialist
	Project Manager

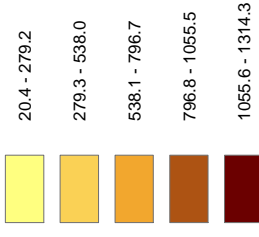

**Figure 11.2.
Combined Scottish and
English Fishing Activity (2002)**

Legend

-  Transboundary line
-  Southern pipeline system
-  6 nm boundary
-  Land

DAYS FISHED



Note: The fishing activity, supplied by SFS and FSU, relates only to vessels between 10 and 17 m in length

© Metoc plc, Data Licence 052003.005. All Rights Reserved.

NOT TO BE USED FOR NAVIGATION

Date	24/January/2004
Projection	UTM Zone 31N
Spheroid	International 1924
Datum	ED 50
Data Source	Metoc Charts, SFS, FSU
File Reference	I:_P517\GIS\AvProj\p517-fishingactivity.mxd
Checked	Jillian Barnes GIS Specialist
	Philip Wemyss Project Manager

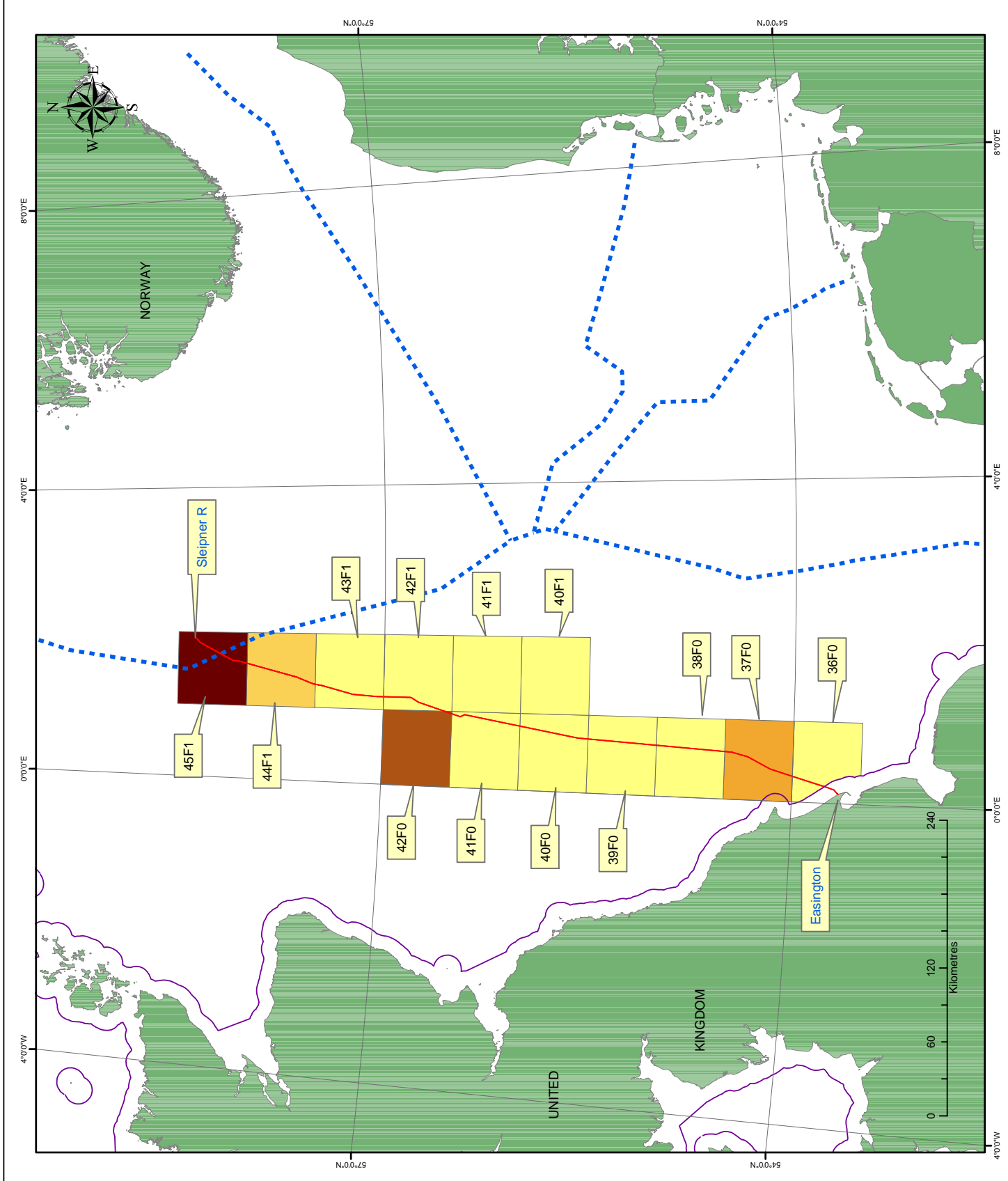

Smothering concerns also relate to effects on the pots, with fishermen noting clogging as the main issue. However, the types of sediments brought into suspension are not likely to cause clogging problems to surrounding pots for the reasons given above relating to the type of sediment. An examination of wave extreme values and tidal currents close to Easington has been undertaken. The findings show (assuming clay particles suspends at 0.75 m/s and silt at 0.05 m/s) that any clay and silt particles brought into suspension by the trenching process are likely to be kept in suspension, or (under conditions which are conducive to settlement of finer material) quickly re-suspended by currents and wave orbital motions. Even though the activity is taking place over the summer months, the mean currents at seabed will still be sufficient to suspend and transport both clay and silt material even down to water depths of 40 m. In addition the wave generated currents at this time of year are sufficient for 10 % of the month to suspend silt particles in water depths between 5 and 16 m. At 40 m; however, from the months of May to August, the wave generated currents are too low to suspend even silt particles. Therefore, there may be some settling out of finer materials during periods of decreased tidal current velocities. However, the majority of the fine material brought into suspension will be transported out of the development area by natural processes and the transported sediments will rapidly disperse; thus, limiting the impact on any other areas, whilst the coarser material will settle out within close range of the dredged or trenched area. Smothering of the surrounding areas is not considered to be a significant threat to the demersal species, due to the transport of finer sediments of out of the area by the prevailing currents, with only minor temporary disturbance occurring as a result of smothering. Beyond this area any suspended sediments will rapidly disperse; thus limiting potential impacts.

In all instances, the associated impacts are not expected to be significant because any intervention work will only directly affect fishing activity for part of the season in 2005 (except the clay hut area see below), and are confined to a small area in relation to the whole ground with sea conditions rapidly re-dispersing any smothering sediments. It is likely that beyond this season no direct effects from the Langeled development would be apparent.

Exclusion Area

Avoidance of the construction area by fishing vessels will be the principal direct impact from pipelaying operations. An exclusion zone of 3 km² will exist around the construction vessels (with a maximum width of 1 km either side of the LB 200 from the Median Line to KP 528 and 500 m in the case of the Tog Mor). However, as the LB200 will move at 2-4 km per day, this zone will not be at a fixed point. For the Tog Mor the designated corridor will remain in place for the duration of the installation period. In all instances trawl vessels will actively avoid the exclusions area without major disruption to their fishing activity, and given the exclusion zones covers a relatively small corridor width in relation to the areas trawled by the vessels impacts will be negligible.

Impacts on static gear will be more notable as all pots will have to be removed in advance of the pipelaying barges and for a period of time it will force boats to net and pot in areas to the north and south of the pipelaying area, which are already intensely fished, as these vessels are too small to be simply move out to sea. This may have an effect on catches during these periods due to a decrease in fishing ground availability. These effects would be most notable in relation to those vessels that launch from Easington and Withernsea. This exclusion zone also partly coincides with the peak season for shellfish fishing. The commercially important species present in the exclusion zone are likely to be disturbed by the development and move out of the

impacted areas to some degree; therefore, these will remain a target for the fishermen. However, no direct effects will extend beyond part of one season.

Anchor Usage

The use of anchors may result in the creation of anchor mounds or scars, the scale and severity of which will vary along the route, depending on sediment type and depth. It is possible that an area of 40 m² may be affected by each anchor drop. Furthermore, the anchor wires may also drag on the seabed and the natural backfilling of finer or disaggregated sediments into the anchor scars. The mounds present a potential impact to demersal trawl gear generally up to KP 531 as no trawling occurs beyond this point. The towed gear can become stuck on the mounds or the nets can be torn if the mounds comprise exposed hard cohesive deposits (clay, bedrock or boulders) (see Figure 6.4).

Rock Dumping and Mattress Placement

The preparatory work for all crossings will commence in February 2005 and be completed by March of that same year; therefore, it will not coincide with periods of peak fishing activity, except potentially in the region of the Cleeton Crossing at KP 536.5 where the potting season in this region begins in March.

Clay Huts Area

In the clay huts region (between KP 542 to KP 543) an area of 160 m wide and up to 6 m deep for the floating channel and 5 m wide and 5 m deep for the cofferdam will be removed from this habitat. This unavoidable disturbance to the seabed will result in the temporary loss of key lobster habitat along this corridor. From the MLW mark to 1,300 m offshore there will also be an extended dredged channel 10 m wide and up to 4 m deep. The works in this region will be coincide with half the peak lobster season with the fishermen being excluded from the construction area. Vessels launching from Easington may also be affected by on shore construction works. There are five existing pipelines all of which pass through the clay hummocks within 1.5 km of the proposed pipeline (see Figure 11.3), all of these will have created similar levels of disturbance during installation to that which is predicted from the Langeled pipeline. This does not appear to have significantly affected the lobster fishery in the vicinity over a long-term period. Nonetheless, it is anticipated that specifically within the works area there will be loss of original habitat and a potential for reduced suitability of habitat for lobsters lasting over a few years. However, when compared to the total habitat, this covers a comparatively small area.

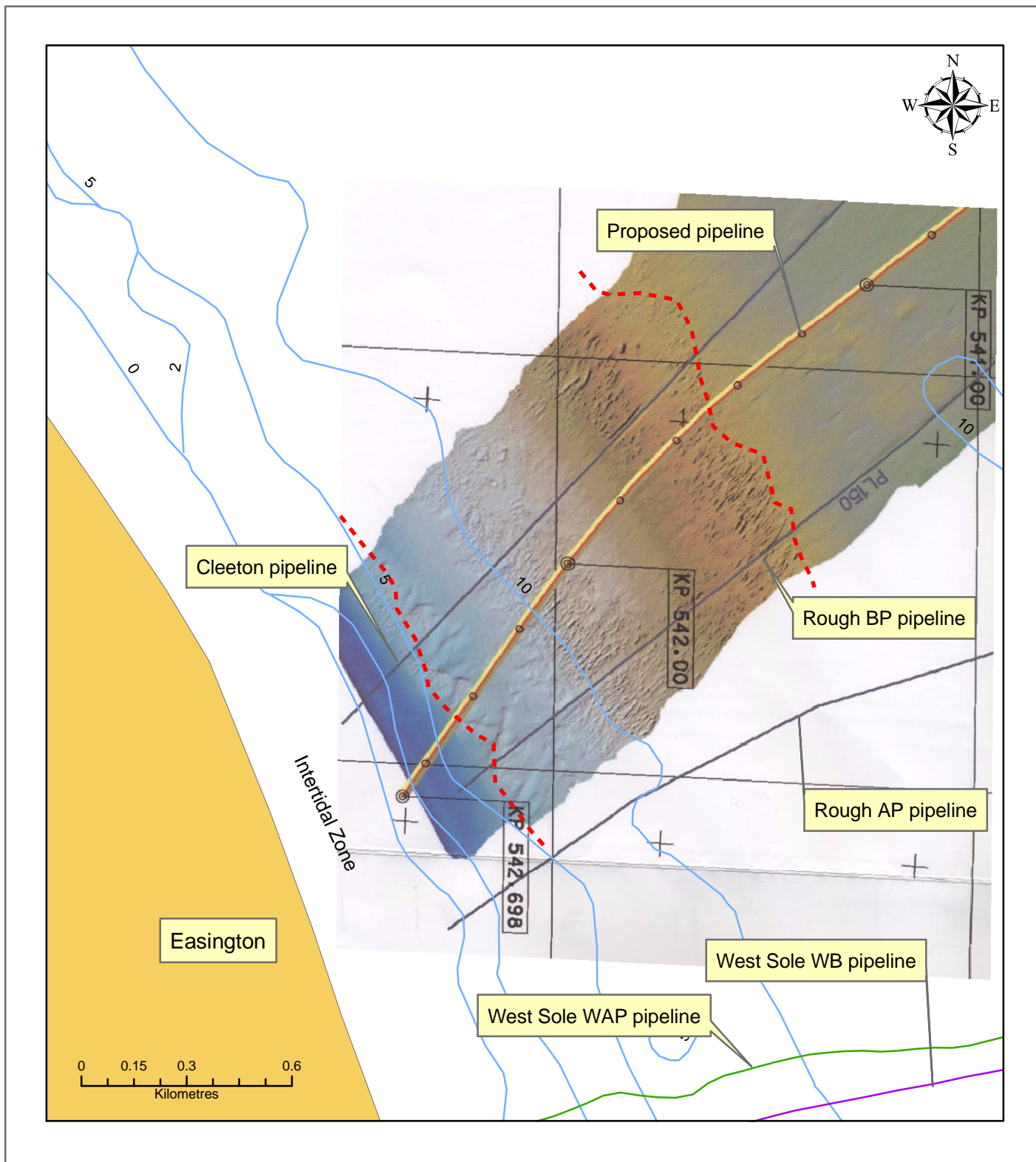

Figure 11.3: Area of Clay Hummocks off Easington

Legend

- Land
- Pipelines**
- West Sole WAP:Shore - Easington
- West Sole WB:Shore - Easington
- Bathymetry (m)
- Clay reef extent

Date	19/April/2004	
Projection	UTM Zone 31N	
Spheroid	International 1924	
Datum	ED_50	
Data Source	Metoc Charts, CMap_V2, Statoil-Norsk Hydro	
File Reference	I://..P517/GIS/Clay_hummocks.mxd	
Checked	Jillian Barnes	GIS Specialist
	Philip Wemyss	Project Manager



Figure 11.4.
Yearly Potting Activity for a Single Vessel off the Holderness Coast (2002)

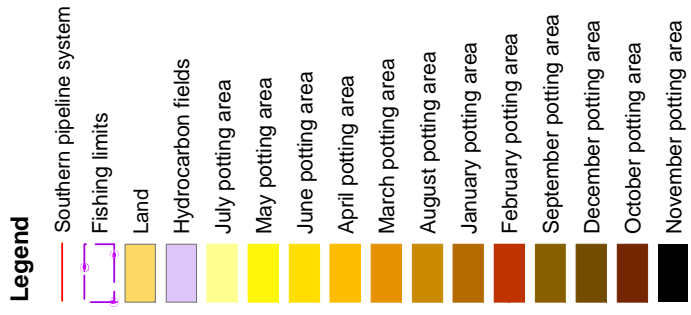

Note: static gear extents shows where majority of gear off the Holderness coast can be expected, some potting activity may occur further a field.

© Metoc plc, Data Licence 052003.005. All Rights Reserved.
NOT TO BE USED FOR NAVIGATION

Date	24/January/2004
Projection	UTM Zone 31N
Spheroid	International 1924
Datum	ED 50
Data Source	Metoc Charts, Danbrit Ship Management Ltd
File Reference	!:/./P517/GIS/AVProj/P517-Yearlypottingactivity.mxd
Checked	Jillian Barnes GIS Specialist
	Philip Wemyss Project Manager

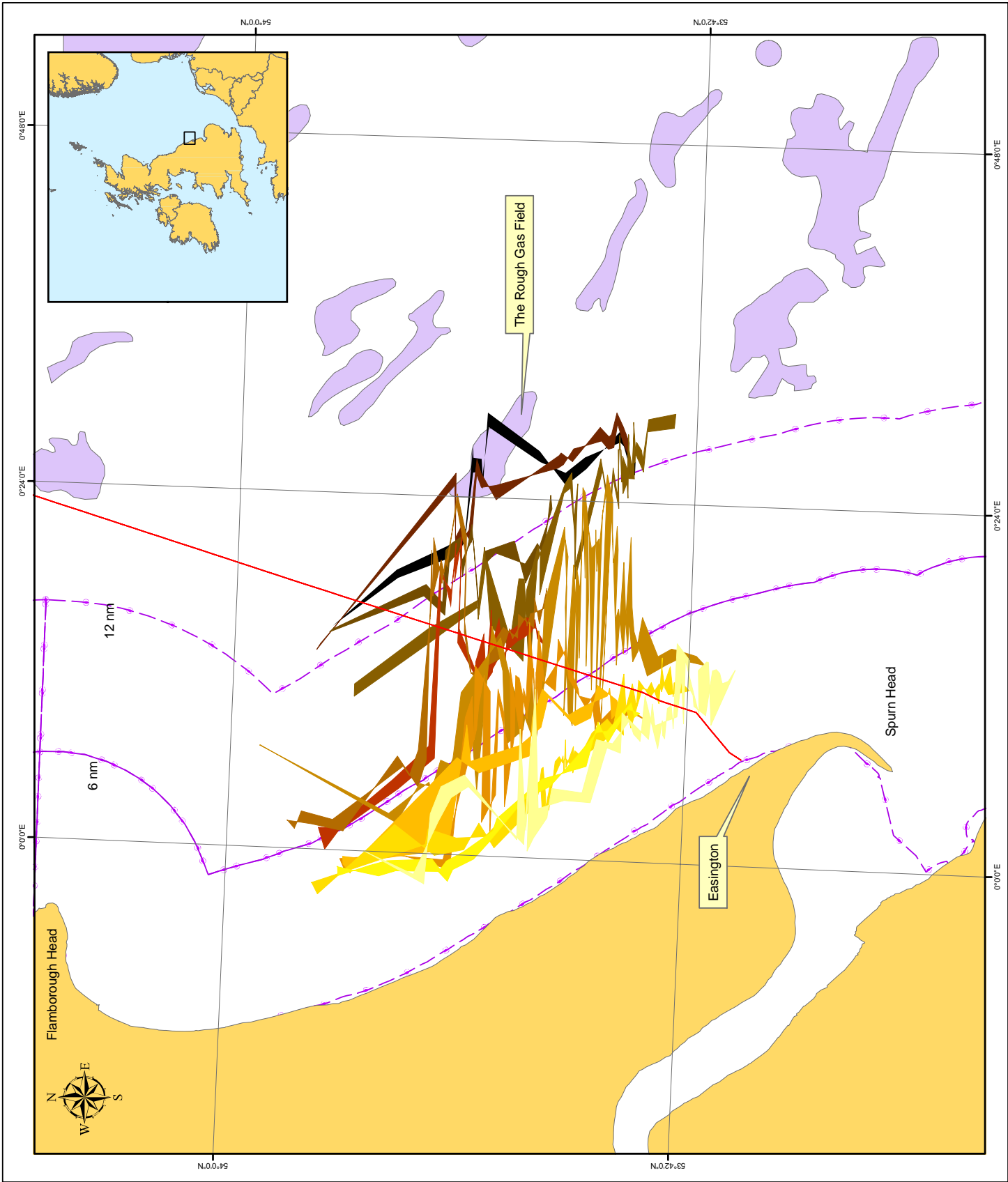

11.3.2 Operation

The physical presence of the pipeline on the seabed is a potential impact to demersal fishing fleets that tow gear along, or close to the seabed. The fishermen's organisations have expressed concern over the overtrawlability of the planned pipeline. Statoil has commissioned a number of trawl tests on large diameter pipeline (up to 42"). Results from these tests, as well as practical experience with Norwegian pipelines, have concluded that overtrawling is generally not considered to cause any significant problems. Pipeline spans are one of the major potential operational impacts to the fishing industry. This issue has been well documented in recent years especially with the Westhaven incident. Any pipeline spans that are greater than 0.75/0.80 m in height have the potential to trap trawl doors under the pipeline. Statoil has been involved in rigorous trawl tests undertaken by a Bundesforschungsanstalt für Füscheria as well as tests on similar pipelines using Norwegian fishing vessels in correspondence with marine fisheries institutes and fisheries organisations. The results indicated that none of the pipelines represented a significant trawl hazard. The findings are summarised below in Table 11.5.

Table 11.5 Summary of Trawl Test Surveys

Trawl test	Pipeline size (inches)	Number of crossings	Damages	Damage frequency
1993: Zeepipe	40"	90	2	2.0%
1998 – 1999: Europipe II	42"	80	2	2.5%
1999: Europipe II (Across rock berms)	42"	7	0	0%
2000-2001: Asgard Transport	42"	27	1	3.7%

Source: Statoil – presentation (August 2003)

Avoiding freespans has been a feature of the design of the pipeline through pre-sweeping the sandwave area beyond KP 451, whilst 50 km of post-lay spot trenching between KP 23 and KP 451, which although undertaken for stability reasons; will assist in reducing freespans in this area.

12 MARINE ARCHAEOLOGY

English Heritage (EH) assumes statutory responsibility under the “*National Heritage Act*” (2002) for marine archaeology. This statutory responsibility extends from the 12 nm territorial limit at KP 517 to the MLW mark. The legal requirements within territorial waters are set out by English Heritage “*Taking to the Water*”, with supporting documents from the Valetta Convention (2002), UNESCO (2001) and DTI [ref 26] and [ref 27]. English Heritage also maintain a watching brief on water beyond 12 nm. Wrecks are not bounded by this limit, although some are considered conservation areas and are afforded statutory protection under two main provisions: “*The Protection of Wrecks (Designation) Order*” (2002) and the “*Protection of Military Remains Act 1986 (Designation of Vessels and Controlled Sites)*” (amendment) (2002) (MRA).

12.1 Methodology

The prehistory archaeology from the Median Line to the 12 nm territorial water limit was compiled as an extension of the geological process assessment considered in Chapter 6 along with a number of secondary archaeological sources. Therefore, it provides a general commentary on the region as a whole based on archaeological potential in relation to erosional and depositional phases in the Late Pleistocene and Holocene geological epochs. These deposits form a large portion of the seabed morphology of the North Sea [ref 15]. Wreck data were obtained 2.5 km either side of the proposed route corridor primarily through the United Kingdom Hydrographic Office (UKHO); English Heritage; Receiver of Wreck Maritime and Coast Guard Agency; and the Naval Personnel Secretariat (Plans and Parliamentary)³².

English Heritage was consulted in July 2003 to comment on the appropriate assessment techniques relating to the potential archaeological heritage within the 12 nm limit. Subsequent discussions, cumulated in a meeting (January 2004) to identify an agreed scope of works. This scope included:

- the provision of adequate information about the location, condition and significance of surviving archaeology;
- the archaeological potential of the seabed along the route;
- the use of primary data to assess unknown potentially significant archaeology;
- seeking advice from a competent archaeological body prior to carrying out a survey of the seabed; and
- re-routing the gas pipeline or placing an exclusion zone around any identified features to avoid impact upon the site.

To address this scope Wessex Archaeology, who specialise in the marine environment, were commissioned to undertake this survey. A summary of their findings is provided here.

Phase I – Desk Based Assessment

The methodology adopted reflects best practice in carrying out archaeological desk-based assessments as set out by the Institute of Field Archaeologists (IFA) “*Standard and Guidance for Archaeological Desk-based Assessment*” [ref 63]. Although much of this assessment is

³² This includes data on known commercial, military, fishing and other marine wrecks, in addition to associated war-graves.

focused on desk-based sources, provision was made to review reports relating to borehole and vibrocore data collected by Fugro Limited (via Statoil) and independent records held by the British Geological Survey at Keyworth. The baseline description of known and potential archaeological resources was compiled in two stages. Records of maritime sites were overlain on a map showing the proposed pipeline route and buffer zone to assess the known archaeological resource within the region from KP 517 to KP 543. Historic patterns of sea level change, geological and geotechnical data were used to characterise prehistoric land surfaces within the pipeline works. This was then combined with an assessment of the known prehistoric populations in coastal areas adjacent to the pipeline works, along with the patterns of human colonisation, occupation and activity across Northern Europe during the early prehistoric period. This characterised the potential prehistoric archaeological resource within the pipeline works.

Phase II – Assessment

Geolab Technical Services Limited were subcontracted by *DeepOcean Subsea Services AS* to provide bathymetric and geophysical survey services for a nearshore route survey at Easington that forms part of the Langeled project. The survey covered the pipeline route between KP 533 offshore and KP 543 at the Easington landfall, a distance of approximately 10 km. The raw survey data were assessed by Wessex Archaeology, accompanied by a specialist geophysical consultant. The assessment covered various anomalies recorded in the side-scan sonar contact list together with the validation of the survey method and the conclusions drawn in the report.

The assessment of significance of the residual impacts of the Pipeline Landfall on archaeological and cultural heritage resources was derived from a consideration of the following issues:

- the scale of the impact in terms of, for example, the extent of the areas affected, and the physical disruption to the resource; and
- the importance of the affected resource.

Impacts to archaeological and cultural heritage resources were graded as follows.

Significant	Very extensive or total disturbance/removal of the resource without any effective mitigation.
Moderate	Moderate overall disturbance/removal of the resource after mitigation.
Insignificant	Limited overall disturbance/removal of the resource after mitigation.
Negligible/ None	The mitigation measures or the position of the resource are such that there would be no disturbance to the resource.
Uncertain	The extent of the archaeological site(s)/historic feature(s) or the nature of development does not enable a determination of likely effects at this stage.

12.2 Baseline Environment

12.2.1 Archaeology

Lower, Middle, and Early Upper Palaeolithic

The archaeological potential relating to the *Lower, Middle, and Early Upper Palaeolithic* epochs shows that, prior to the Devensian glaciation (the last ice covering), was subject to a variety of environmental changes as the climate cycled between warm and cold periods. These included periods of submergence and exposure of the land surface. During the periods when the landscape was exposed, it seems likely that the region provided a suitable environment for human occupation. The earliest occupation of Britain during in the Cromerian period (c.500,000 before present) the whole of the southern North Sea would have been a low-lying wetland landscape and would have made an attractive environment for hunter-gatherer communities. Therefore, sediments laid down at this time, prior to the deposition of the overlying Bolders Bank Formation, may contain *in situ* Lower Paleolithic sites and/or artefacts. However, the upper reaches of the formation over much of the southern North Sea is likely to have been eroded during successive marine transgressions [ref 15]. The Middle Palaeolithic epoch in Britain is generally poorly represented in the archaeological record and implies that the entire country was uninhabited at this time (Wymer, 1999 [ref 127]). Towards the end of the Middle Paleolithic (c.40,000 before present) there is evidence of human presence at a time when a land bridge was formed with the continent as a result of sea level change. However, this activity ends during the Devensian glacial maximum when the study area would have been entirely covered with water.

In order to assess the evidence for human occupation, it is important to consider archaeological potential outside the study area as the geological profiles and units in which materials have been discovered can extend into the area covered by the pipeline development. Terrestrial sites outside of the study area on the cliff have yielded a limited amount of small isolated Palaeolithic finds (i.e. an Elephant's tooth and flint scraper). However, no materials of this nature are local to the development footprint. Of the few recorded Palaeolithic find spots, none can be attributed directly to the Lower Palaeolithic. There is one possible Mid-to-Late Middle Palaeolithic artefact, a flint scraper, found approximately 3 km from the development footprint. An Upper Palaeolithic barbed antler point has also been discovered during excavations of a Devensian Late Glacial sediment sequence in a quarry near Gransmoor, Yorkshire [ref 105]. Whilst this is approximately 66 km north and 5 km from the coast, it is in the same geological sequence as the nearshore and offshore platforms off the Easington coastline. The Lower and Middle Palaeolithic epoch is characterised by periods of colonisation and occupation and then 'refuge' [ref 58], as the climate moved between warm and cold periods over various parts of northern Europe. The pattern of occupation varies between areas; however, a broad description for Britain is discussed below. As a result of climatic variations during the Lower Palaeolithic, "*occupation was not continuous, but intermittent over an unknown period to be measured in centuries if not millennia*" [ref 126]. In fact, during the Middle Palaeolithic there is a general 'absence' of sites and finds within the British archaeological record. This has been taken to suggest that the country may have been uninhabited at this time [ref 126], although towards the end of the Middle Palaeolithic (c.40, 000 before present) there is evidence of the arrival of humans, at a time when sea level was lower than at present. This activity appears to cease after the Devensian glacial maximum (i.e. from c.22, 000 to 13, 000 before present).

Late Upper Palaeolithic, Late Glacial and Mesolithic

The archaeological potential relating to the *Late Upper Palaeolithic, Late Glacial and Mesolithic* epoch shows that after the end of the last glacial event (the Dimlington Stadial) there is a higher potential for archaeological remains in Britain. The island as a whole would have become more attractive to hunter-gatherer communities as it warmed up especially in and around the large tidal-flat areas in the southern North Sea Basin, which provided a good potential food source. Mesolithic activity in the general area is documented by the discovery of the internationally important site of Starr Carr, a lakeside Mesolithic dwelling site, located in the Vale of Pickering to the north of the Humber Wetlands. However, this is a considerable distance inland to the north although it is still in the same geological profile.

Offshore as the last ice sheet retreated it became depositional releasing eroded materials contained within it as melting occurred. This glacial melt resulted in a variety of deposits laid down in highly dynamic; sub-glacial, glacio-fluvial³³, glacio-lacustrine³⁴ and glacio-marine environments. None of these would have been conducive to permanent human settlement until the ice had retreated well to the north during this last glacial event. Approximately 12,000 years before present the ice had retreated to a position to the north of the UK/Norway Median Line, and the resultant rising sea-level moved across the uneven glacial landscape. Sea-level rise was rapid, with the shoreline moving to a position off the Humber between 10,000 and 9,500 before present [ref 65] and [ref 106]. The rising sea eroded the glaciated surface, sorting the materials, and in the case of the pipeline route, swept the finer silts and clays offshore towards the north. The eroded sand fractions were deposited into a series of shallow marine sandbanks; which are referred to as the East Bank Ridges that now lie immediately to the east of the pipeline route between 56°N and 55° (KP 276 and KP 389). To the west and south of the Dogger Bank, formerly a low marshy upland area and later an island, was an area of low ground occupied by a river system. As the sea advanced towards the south this river valley became an estuary with associated mud and sand flats (much as the Humber estuary is at present). It is here that human activity might have been concentrated. As sea level rose further this estuary became a marine strait (the Dogger Strait) and the river and estuarine deposits were redistributed by tidal activity giving rise to the Sand Hills series of sandbanks and associated sandwaves

Close to the coastline, in Holderness, there have been a large number of finds on land comprising Maglemosian barbed bone points, either harpoons or spearheads. These have either been found on higher gravel ridges, or in mere deposits. Harpoon points of antler have been discovered in the Hornsea beach and another bone harpoon point has been recovered from the base of a kettle hole near Gransmoor [ref 114] and [ref 105]. These kettle holes would have protected archaeological and/or environmental material, making them the most archaeologically sensitive areas likely to be encountered during trenching operations; however, none have been located close to the development footprint. In order to assess the evidence for human occupation, it is clear that there is no evidence of any Mesolithic material within the study area or its terrestrial footprint, although the finds mentioned above do highlight the, albeit unlikely, potential that may exist within the study area. The only evidence of environmental material that may date from the Late Palaeolithic/Mesolithic era was observed as a thin “...*band of black very sandy clay including organic material at 2.5 m*” observed within a borehole record in the Fugro Ltd geotechnical report. However, this horizon is at least 2 m above MLW (see Figure 12.1).

³³ Geomorphic feature whose origin is related to the process associated with glacial meltwater.

³⁴ Sediment deposited in lakes marginal to a glacier.

Although the extent of the organic layer, or lens, is not known, it is highly improbable that this horizon extends to within the development footprint area of the marine pipeline section. The exact date of this material has yet to be determined, although the amount of previous disturbance in the area, ranging from previous pipeline construction to coastal defence and modern building remains suggest that this material may derive from a modern context. An example of this disturbance was encountered when a second borehole northwest of that which contained the organic horizon was terminated at 1.5 m depth by a large concrete obstruction.

Regarding contemporary eroded terrestrial sites, approximately 22 villages are known to have been lost to the coastal erosion process within the general area, remains of which may be located within the development footprint. A number of these have been highlighted in the AC Archaeology report, which included a review of several early editions of Ordnance Survey maps [ref 22]. There has also been the excavation of the coastal sites of a Bronze Age 'hengi-form' monument and associated barrow burial in 1998, which were in the process of being eroded.

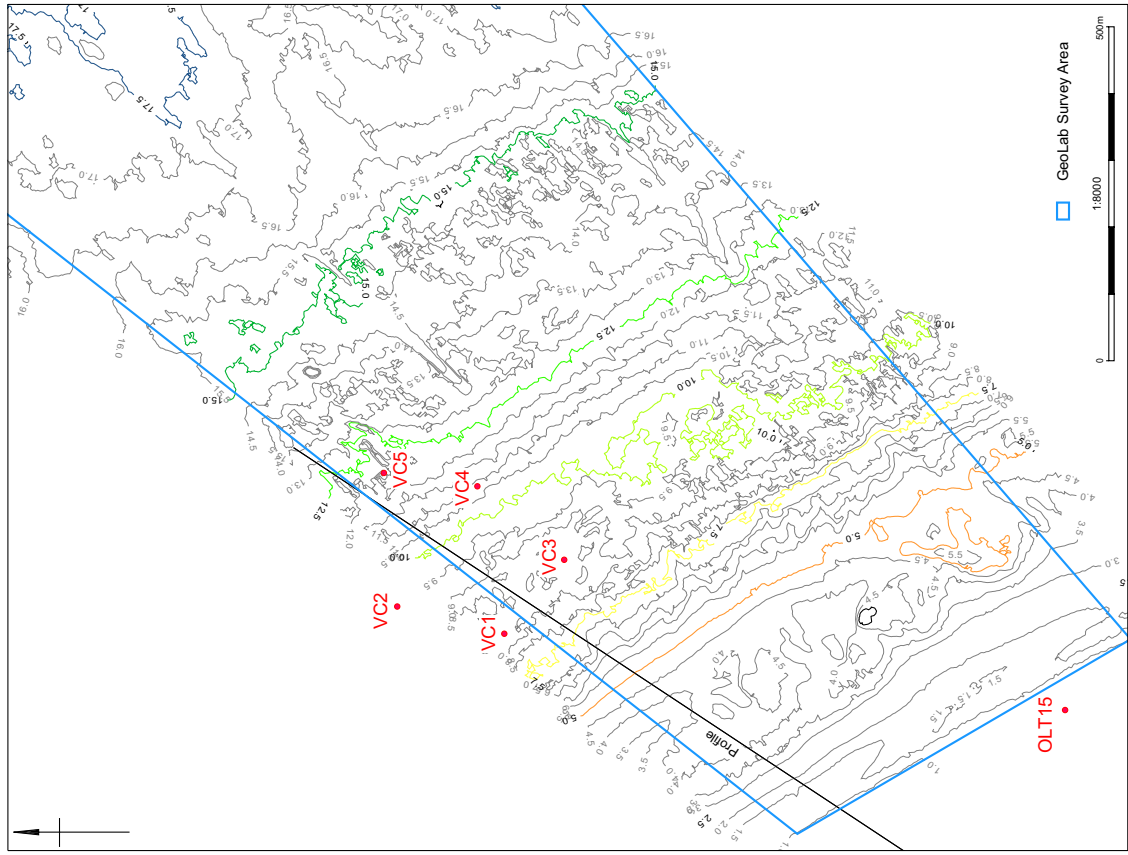

Countour map (after Geolab 2003) showing position of vibrocores and borehole

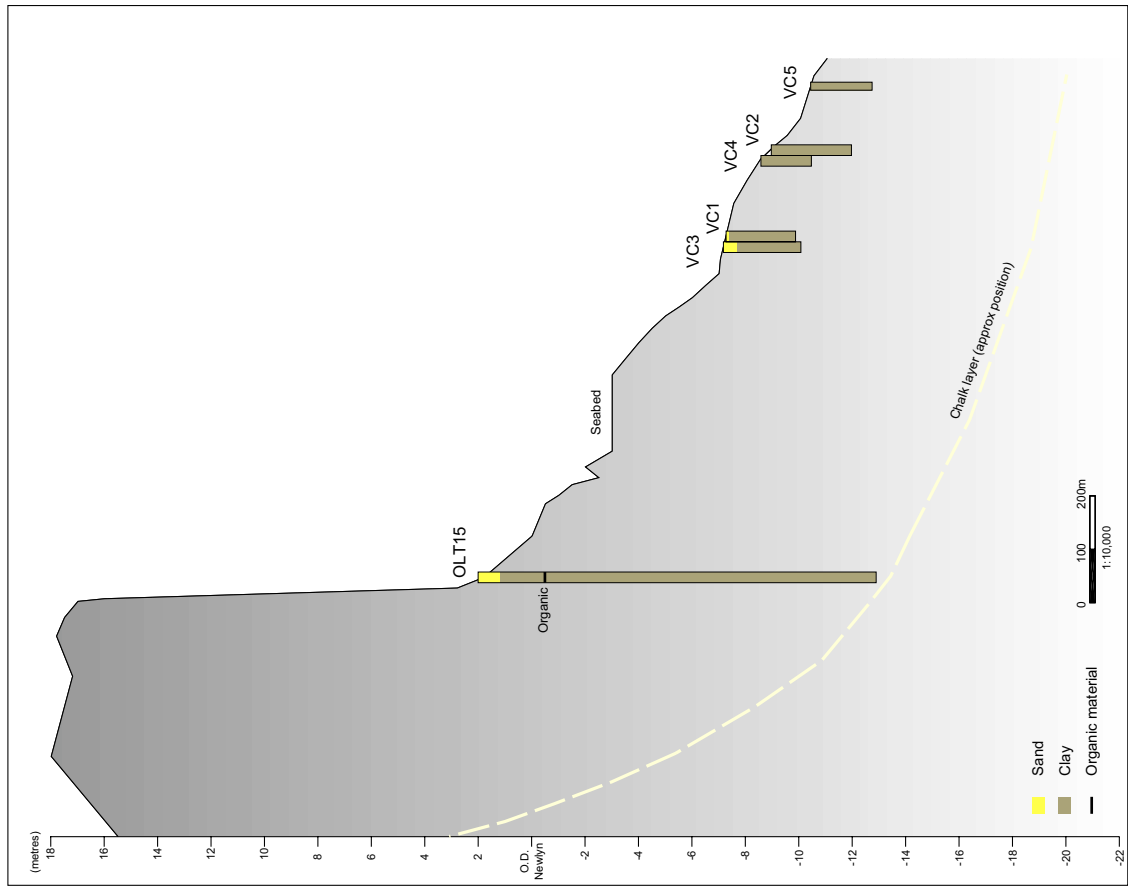

Seabed profile with vibrocores and borehole

Date:	05/03/04	Revision Number:	0
Scale:	See drawings	Illustrator:	KJB
Path:	W:\55560\Drawing office\Report figures\Fig 3.dwg		

Figure 12.1 - Broad sedimentary units within vibrocores and borehole

12.2.2 Known Maritime Sites

A search of UKHO data up to the 12 nm limit revealed a total of 26 recorded wrecks/obstructions (see Figures 12.2 and 12.3). None of the wrecks identified are designated historic wreck sites, or military maritime graves, with 24 being classified as live and two dead³⁵. Up to the MLW mark 16 recorded shipwreck and seabed obstructions, and 12 shipwrecks at two named locations [ref 118] (see Figure 12.4).

On assessing the collected side-scan data the assessment concluded that the original interpretation was detailed and comprehensive.

Table 12.1 Wrecks up to 12 nm (KP 23 – KP 519)

ID	Latitude	Longitude	Object	Wreck Category	Flag	Date Sunk	Status
4781	55.39628	0.66306	Obstruction				Live
4787	55.37794	0.70167	Obstruction				Live
4788	55.36156	0.66000	Obstruction				Live
4789	55.36461	0.69361	Obstruction				Live
2491	57.01044	1.15389	Wreck	Non-Dangerous			Live
2496	57.26600	1.26500	Wreck	Non-Dangerous	German	05/06/1915	Live
4821	55.10544	0.64000	Obstruction				Live
4823	55.05656	0.63267	Obstruction				Live
4794	55.33100	0.69722	Obstruction				Live
4796	55.31989	0.70417	Obstruction				Live
4798	55.29211	0.66472	Obstruction				Live
4803	55.24961	0.66028	Obstruction				Live
6499	54.13472	0.40000	Wreck		British	17/05/1911	Dead
6512	54.24188	0.44819	Wreck			02/11/1888	Dead
6519	54.27347	0.46808	Wreck	Non-Dangerous	Dutch	11/01/1978	Live
6539	54.89597	0.61896	Wreck	Non-Dangerous			Live
6584	54.03581	0.34961	Wreck	Non-Dangerous			Live
6593	54.91069	0.61063	Obstruction				Live
6596	54.20857	0.45320	Wreck	Non-Dangerous			Live
6610	54.64878	0.63064	Wreck	Non-Dangerous			Live
6613	54.81348	0.62369	Wreck	Non-Dangerous			Live
6686	54.01692	0.33156	Wreck	Non-Dangerous			Live
6687	54.02081	0.34294	Wreck	Non-Dangerous	British	01/04/1918	Live
6688	54.11940	0.36431	Wreck	Non-Dangerous			Live
6696	54.083570	0.33154	Wreck			07/02/1991	Live
6697	54.47687	0.61649	Wreck	Non-Dangerous			Live

Source: UKHO and Metoc *plc* (2004)

³⁵ Wrecks are either defined as: a Live Wreck – a wreck/obstruction considered to exist by the UKHO or the Receiver of Wrecks; a Dead Wreck – a wreck/obstruction not detected by repeated surveys and therefore considered not to exist by the UKHO; or a Named Location – a wrecking event known to have occurred within the general area but a precise position is unknown. The wreck is then given an assumed location.

Figure 12.2
Wrecks Located up to the
12nm limit (KP 23 - KP 385)

Legend

- Obstruction type**
- Obstruction - Foul ground
 - Wreck - Undefined
 - Wreck - Non-dangerous
 - Wreck - dangerous
 - Transboundary line
 - Southern pipeline system
 - Land
 - 2 km buffer of pipeline route

© Metoc plc, Data Licence 052003.005. All Rights Reserved.
NOT TO BE USED FOR NAVIGATION

Date	27/January/2004
Projection	UTM Zone 31N
Spheroid	International 1924
Datum	ED 50
Data Source	Metoc Charts, Statoil, SeaZone
File Reference	I://.P517 - wrecksB.mxd
Checked	Jillian Barnes
	Philip Wernyss
	GIS Specialist
	Project Manager

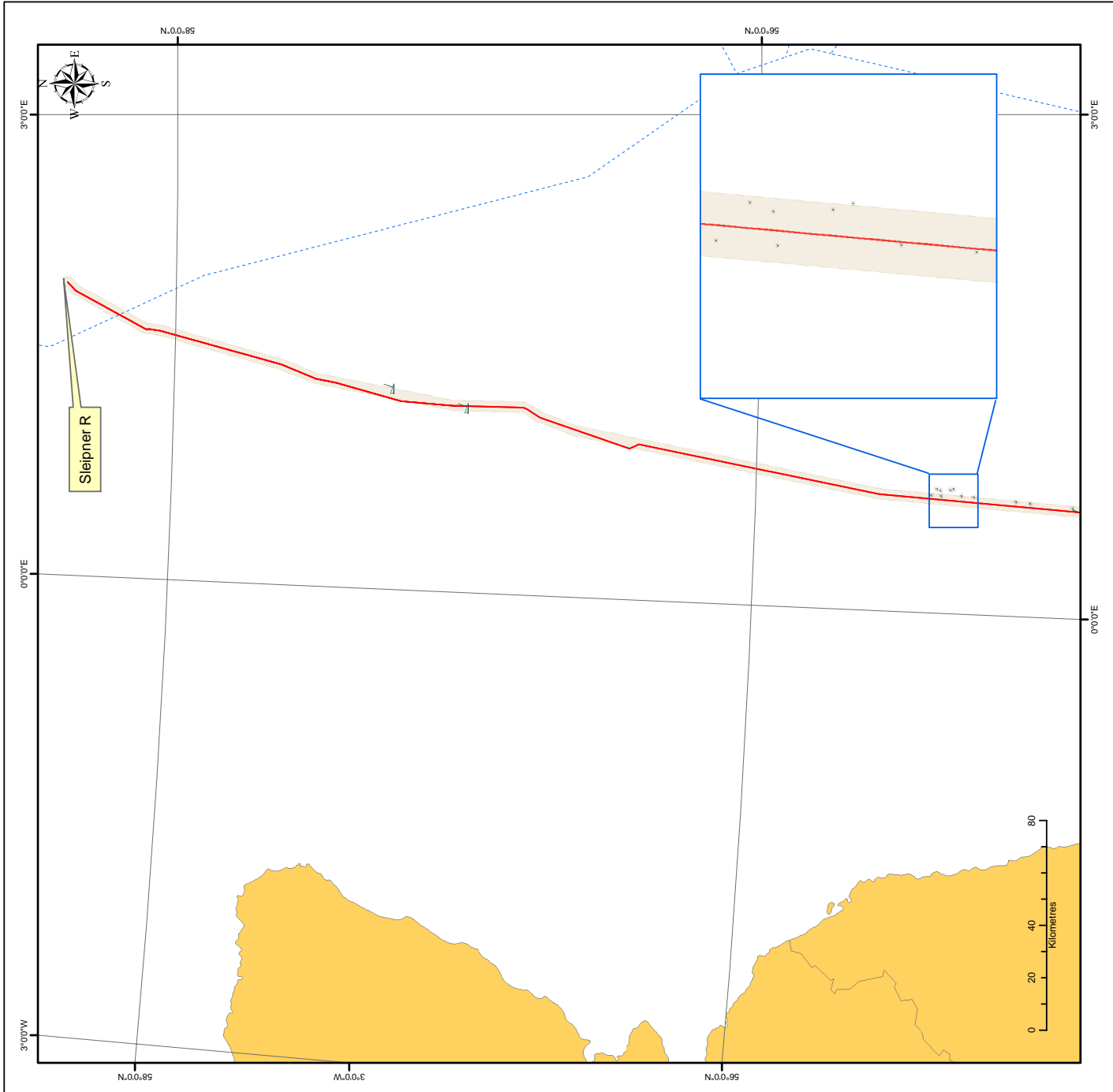

Figure 12.3
Wrecks Located up to the
12nm Limit (KP 386 - KP 517)

Legend

Obstruction type

- Obstruction - Foul ground
- Wreck - Undefined
- Wreck - Non-dangerous
- Wreck - dangerous
- Southern pipeline system
- 12 nm boundary
- Land
- 2 km buffer of pipeline route

© Metoc plc, Data Licence 052003.005. All Rights Reserved.
 NOT TO BE USED FOR NAVIGATION

Date	27/January/2004
Projection	UTM Zone 31N
Spheroid	International 1924
Datum	ED 50
Data Source	Metoc Charts, Statoil, SeaZone
File Reference	I://..P517 - wrecksA.mxd
Checked	Jillian Barnes
	Philip Wernyss
	GIS Specialist
	Project Manager

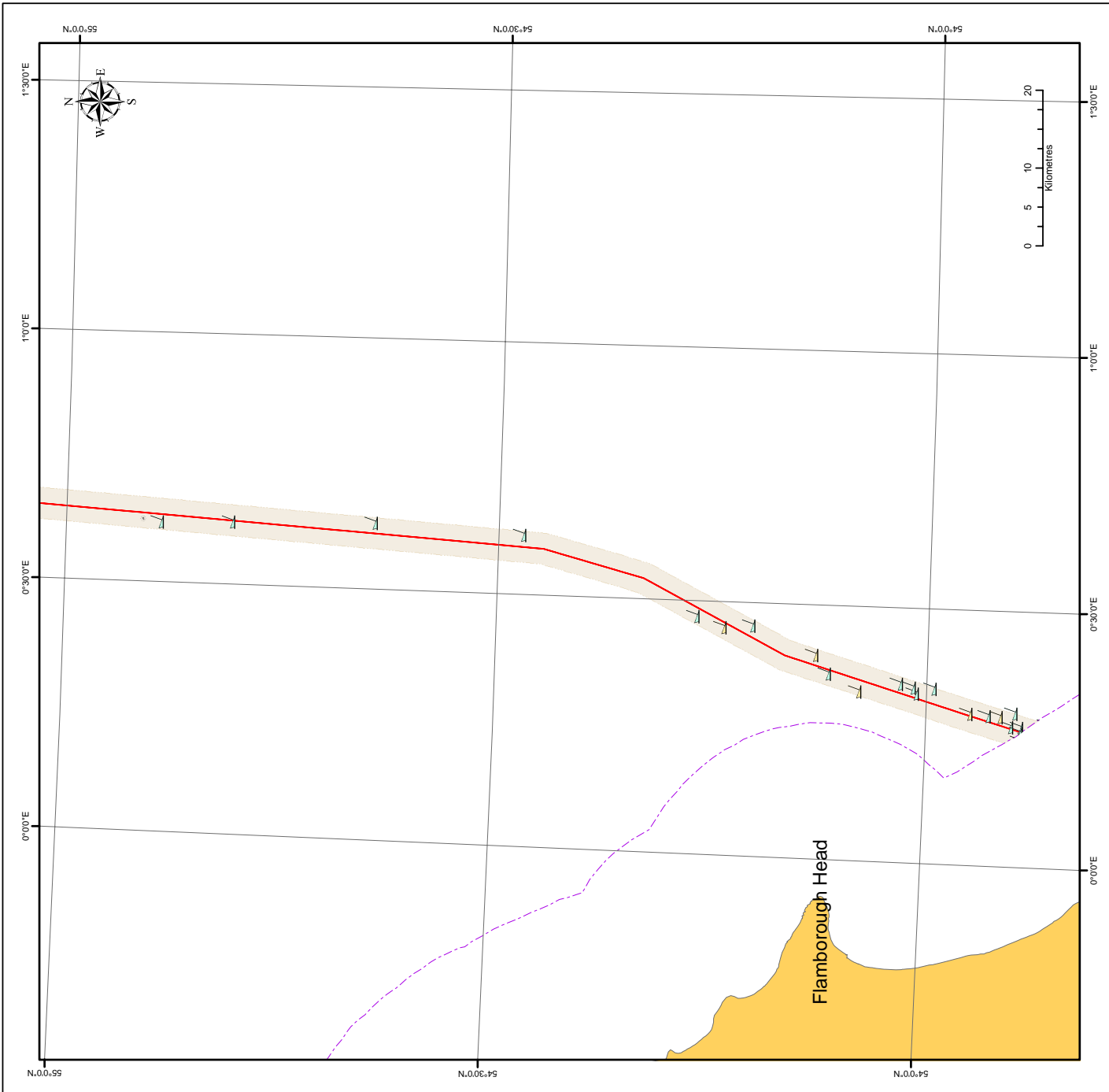

12.3 Assessment of Impacts

12.3.1 Archaeology

Where the pipeline route crosses the Dogger Strait to the west of the Sand Hills sandbanks through a sandwave field (KP 456 and KP 496) is where erosive/redistributary activity was at its minimum, however, the likelihood of finding signs of human activity is considered to be low. The southern bank of this fluvial/estuarine feature becomes evident, as steepening contours to the south of approximately KP 506 and extends to KP 533. Erosion would have been severe as the sea-level continued to rise rapidly. Later, approximately 10,000 before present, as the rate of rise of sea-level began to decrease, the Holderness cliffs, which formed the highest ground at the south-western edge of this estuary system, began to be systematically eroded; a process that continues to this day. This can be seen around KP 533. All signs of human activity and habitation on this upland area will have been eroded into the sea.

From KP 517 to KP 543 the study indicates that the dredged area will impact on a thin layer of Holocene sands and on the upper reaches of an earlier glacial till, the Boulders Bank Formation. The pre-dredged area will impact a 35 m wide area of seabed up to KP 542 but increasing to 158 m within the floating channel area. The maximum depth of the works will be 6 m. Based on this, the pipeline construction could potentially have:

- negligible effects on any Lower, Middle and Early Upper Palaeolithic *in situ* deposits or artefacts;
- negligible effects on any Lower, Middle and Early Upper Palaeolithic derived artefacts that may be present within the dredged trench material;
- insignificant effect on Late Upper Palaeolithic and Mesolithic on any *in situ* sites;
- insignificant effect on Late Upper Palaeolithic and Mesolithic on any derived artefacts that may be present within the dredged trench material;
- negligible effect on any Palaeolithic or Mesolithic fine-grained or organic deposits of palaeo-environmental importance; and
- negligible effect on any eroded terrestrial sites.

The baseline assessment suggests that the potential for discovering any such artefacts, sites, organic deposits or eroded terrestrial sites is limited. However, should any materials be discovered they may be of “high, possibly national and international importance to the archaeological record” [ref 118].

On reviewing a number of survey lines of data it was concluded that the contact list³⁶ was sufficiently reliable. The data did not reveal any contacts of archaeological significance that were identified by the archaeological desk-based assessment. Although there remains a potential for unknown archaeology to be present, the likelihood is limited.

There will be no effect on sixteen known shipwrecks and seabed anomalies in the region. Two of these wrecks (WA 2015) were reported to lie within 250 m of the proposed pipeline route and will be actively avoided by vessels and anchors.

³⁶ A record of all notable items found during the survey.

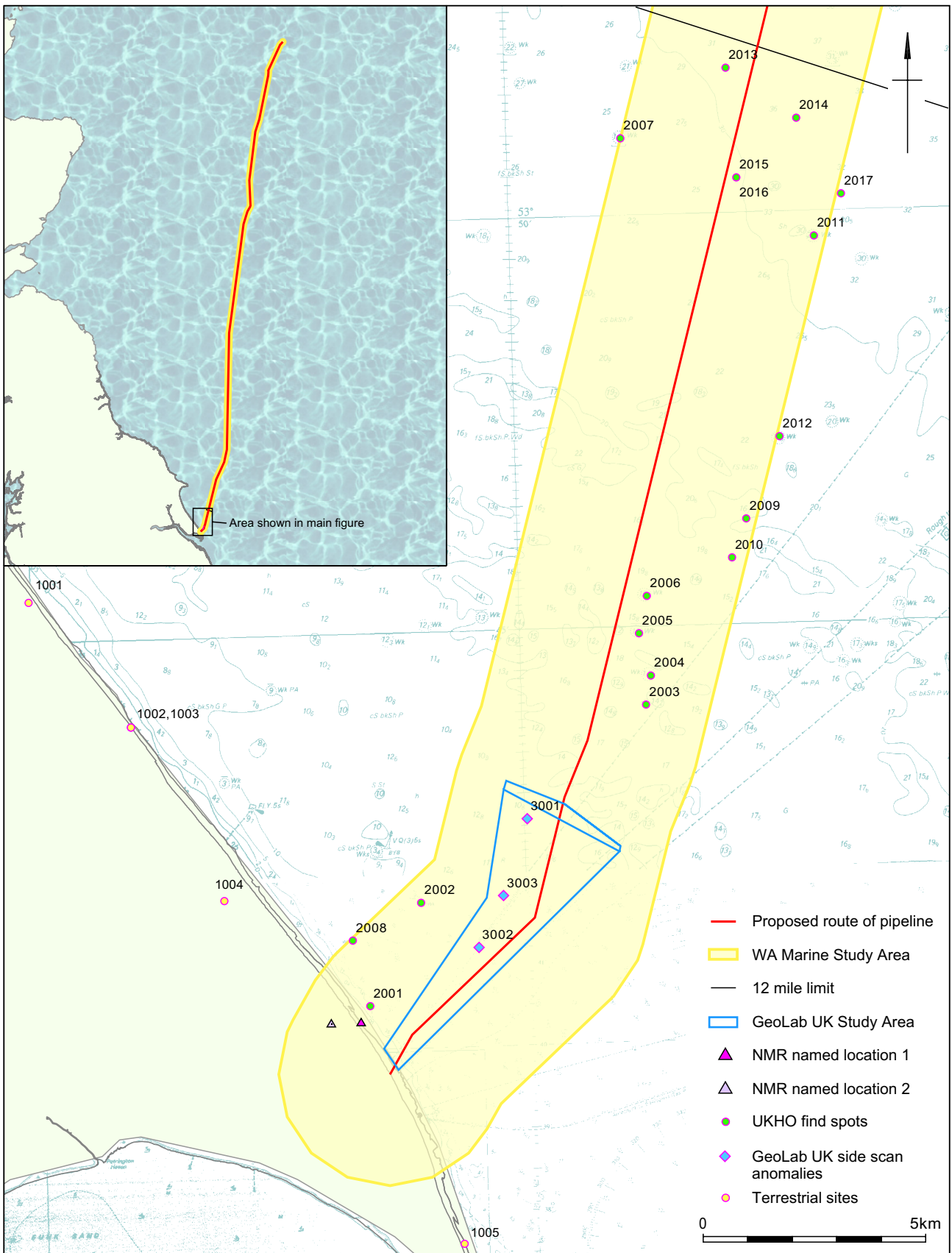

This material is for client report only © Wessex Archaeology. No unauthorised reproduction.

Date: 16/02/04

Revision Number: 0

Scale: 1:125,000 (inset 1:6,000,000)

Illustrator: KJB

Path: W:\55560\Drawing Office\Ormen Lange figs.dwg

Figure 12.4 - 'The limits of the MSA and Summary of Baseline Data

13 SOCIO-ECONOMIC ACTIVITIES (OTHER THAN FISHERIES)

Within the UKCS there are several socio-economic activities that could potentially be impacted by the marine pipeline. These include: oil and gas production and exploration; submarine cables; wind farms; military activity; dredging and dumping; shipping; and recreation.

13.1 Methodology

Oil and gas infrastructure data were obtained from digitally centralised UKCS oil and gas activity information provided by [ref 28]. This dataset holds information formerly published in the ‘brown book’. *Oil and gas pipelines crossings* along the right of way have been taken from engineering data provided by Snamprogetti and supported by DTI published data. *Cable crossing* points have been identified from Admiralty Cable Awareness Charts, Global Marine and route position list. These sources identify all the in-use cables, and most of the out-of-use or abandoned cables, although the position of the latter can often be inaccurate due to errors in historical positioning systems. These have, therefore, been geo-referenced during pipeline route survey work with a magnetometer or metal-detector device.

Information on planned future *offshore wind farms* has been obtained from the Crown Estate and the renewables division of the DTI. Further information concerning the proposed Westernmost Rough wind farm site has been provided from Total as this overlaps with the proposed pipeline route off Easington.

Military areas were identified on publicly available Practice and Exercise Area (PEXA) charts. *Potential ordnance* in the study area (extending 5 km either side of the proposed pipeline route) has been assessed in an Ordnance Contamination Risk Assessment undertaken specifically for this project [ref 41]. *Dumped material at sea* data were obtained from tables produced by CEFAS from the DEFRA’s Digest of Environmental Statistics (September, 2003). Data on *recreational, leisure and tourism activities* are considered in the *pipeline landfall and receiving facilities* ESs.

The impacts for the socio-economic assessment were based on the associated financial implications, the loss of, or access to, a resource and the disturbance to disposal sites and commercial shipping. The following grades were generated as a consequence.

Significant	The development represents a hazard to existing, licensed or consented activities, in that it may cause: major material financial loss; a permanent loss of resource; a permanent block in access to resource; a risk of loss of containment to existing disposal sites; or permanent disturbance to commercial shipping activity
Low	The development represents a minor financial hazard to existing, licensed or consented activities that may result in small scale financial loss, design alteration, or short-term (a return to normal conditions following cessation of development works) loss of or access to resource, or short term disturbance to disposal sites or commercial shipping activity
Negligible	The development has no impact at the financial, spatial or disturbance impacts

13.2 Baseline Environment

13.2.1 Oil & Gas Infrastructure

All licensed blocks holders, through which the pipeline passes, have been contacted. The pipeline does not cross any active fields; however, within 10 km of the right of way, thirteen fields exist, of which eight are active and will be avoided (see Table 13.1) The remaining four are inactive areas: Morag, Moria, Mabel and Maureen (16/29a) all of which lie close to the UK/Norway Median Line (KP 23- KP 41). See Figure 13.1 which shows the proposed pipeline route from south to north (A, B and C), with associated infrastructure.

A large number of exploration, appraisal, development, and injection (water, cuttings and produced water) wells have been drilled over the past three decades, in the North Sea. Table 13.1 lists those wells within 500 m of the planned route, which have the potential to be re-entered should exploitation become economically viable or an injection process be required. To account for the effects of anchoring Table 13.2 lists wells that lie in the possible anchor spread area; specifically 2.5 km from the pipeline route.

Table 13.1 Wells within 500 m of the pipeline route

Well Name	Condition/Use	Status	Easting	Northing	KP Point
16/28-8	P&A oil	Not Active	58.055528	1.588222	41
16/28-12	Gas & Condensate	Active	58.058583	1.597694	41
22/12a-1	Suspended Oil Well	Not Active	57.644356	1.4183	123
22/13a-1	Suspended Oil Well	Not Active	57.626361	1.416944	91
22/13a-4	Tight Hole	Active	57.623194	1.404083	91
22/22a-1	P&A Dry	Not Active	57.329511	1.265822	124
29/06a-6	Abandoned	Not Active	56.755417	1.116611	189
42/09-1	Unknown	Unknown	54.759097	0.619637	416
42/18-2	Abandoned	Not Active	54.477867	0.593675	447

Table 13.2 Wells within the Possible Anchor Spread Corridor

Well Name	Condition/Use	Status	KP Point	Well Name	Condition/Use	Status	KP Point
16/29-3	P&A dry	Not Active	29	22/21-8	Abandoned	Not Active	134
16/29-2	P&A oil	Not Active	31	22/22b-2y	Completed	Active	138
16/29a-12	Unknown	Unknown	34	22/22b-2z	Abandoned	Active	138
16/29a-6	P&A oil shows	Not Active	35	22/22b-2	Abandoned	Active	138
16/28-2	Junked and	Not Active	38	29/01c-4	Abandoned	Not Active	163.2
22/03a-1	Abandoned	Not Active	61	29/06a-1	Abandoned	Not Active	181.5
22/08-1	Abandoned	Not Active	77	29/06a-4	Abandoned	Not Active	183
22/08-4	Abandoned	Not Active	77	42/13-1	P&A Dry	Not Active	432
22/12b-4	P&A Dry	Not Active	135.5	42/27b-2	Abandoned	Not Active	492
22/13a-2	Suspended Oil Well	Not Active	88				

Source: [ref 28]

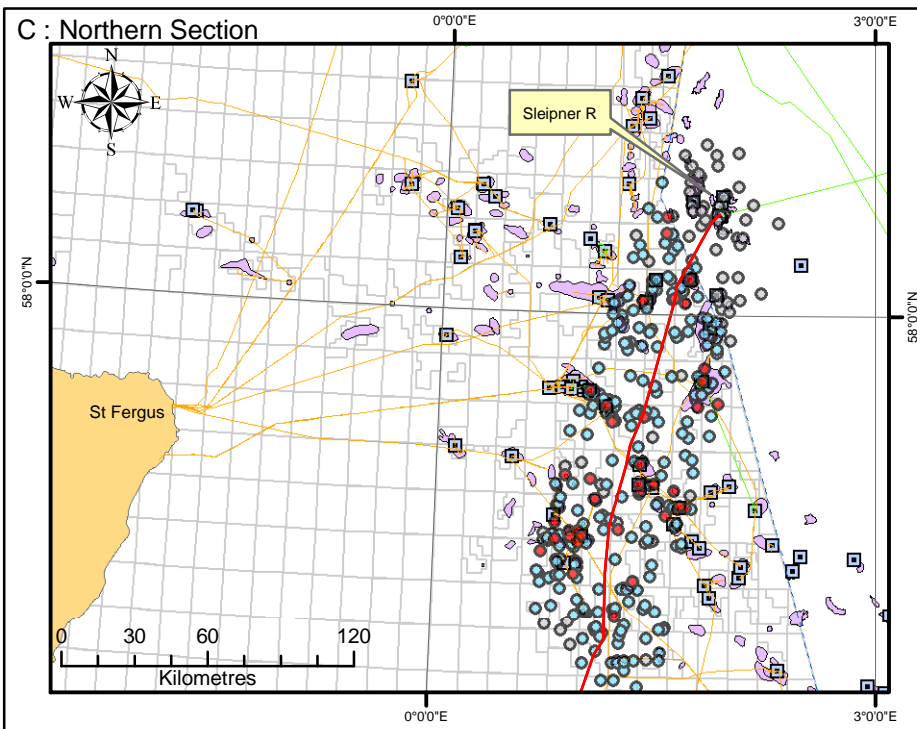
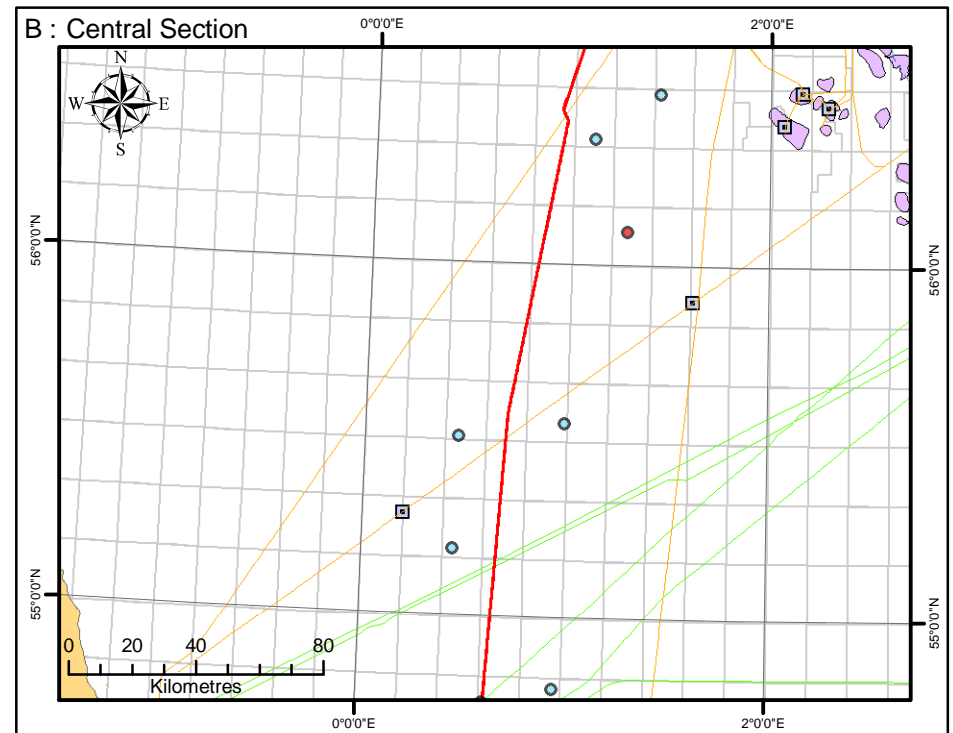
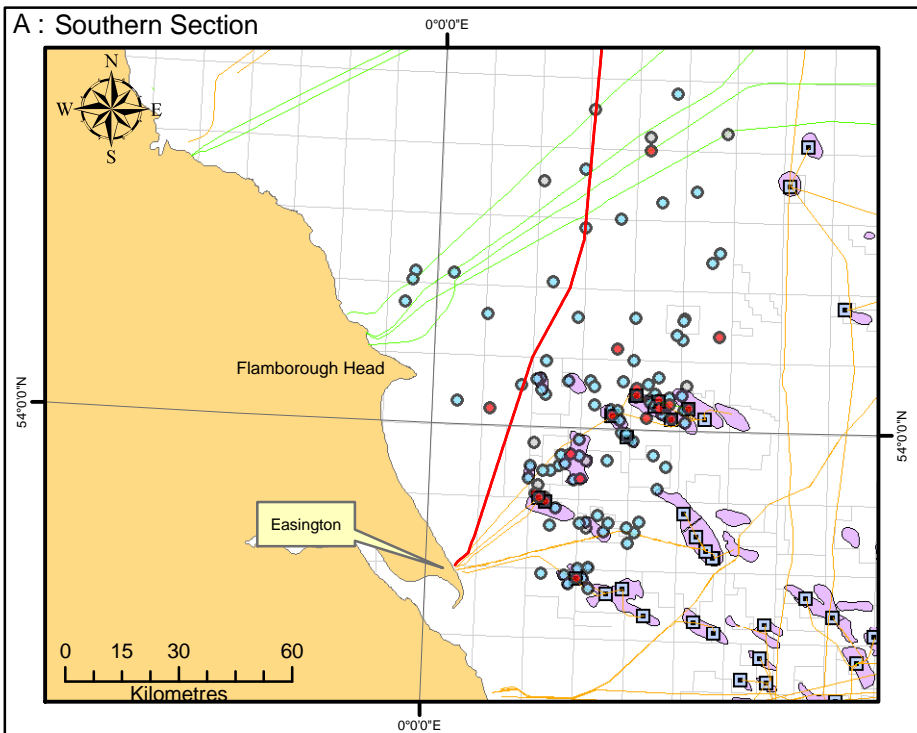

Figure 13.1 Oil & Gas Infrastructure and Cables

Legend

- Transboundary line
- Southern pipeline system
- Wells 20km from pipeline**
- Active
- Not Active
- Unknown
- Cable
- Pipeline
- Platform
- Oil/gas field
- License Block
- Land

© Metoc plc, Data Licence 052003.005. All Rights Reserved.
NOT TO BE USED FOR NAVIGATION

Date	27/January/2004	
Projection	UTM Zone 31N	
Spheroid	ED 50	
Datum	ED 50	
Data Source	Metoc Charts, Statoil, CEFAS	
File Reference	I:/.../P517/GIS/AvProj/P517- Oil & Gas infrastructure.mxd	
Checked	Jillian Barnes	GIS Specialist
	Philip Wemyss	Project Manager



For safety reasons a 500 m exclusion zone is placed around all fixed platforms. The proposed anchor spread area does not coincide with any such exclusion zone within the UKCS. The closest fixed platform, Montrose M, is located approximately 5 km east of KP 99 followed by Bittern A 7 km west of KP 171. These are the closest long-term source of anthropogenic activity to the proposed development.

At the time of writing there are no planned decommissioning programmes within, or immediate to, the anchor spread area; however, some of the fields in the northern section of the route are mature and could be decommissioned. Due to the various techniques that could be employed to decommission these facilities they have not been considered as part of this *marine pipeline* ES.

One Field Development Programme approval was granted in 2002/2003 close to the anchor spread area. This is the Seymour Field in Licence Block 22/05-b, 20 km east of the right of way at approximately KP 60. The field was brought into production in March 2003 and is operated by BG. An additional nine approvals for activities within 40 km of the anchor spread area were granted within the 21st Seawards Licensing Round Awards, all of which relate to seismic surveying.

Table 13.3 Full List of Approvals Close to the Proposed Development

Operator	Partner(s)	Block(s)	Firm commitments
Paladin	-	22/12b, 22/16b	Acquire 3D seismic
Carrizo	-	22/13b	Acquire 3D seismic
Veritas	-	28/10b	Seismic analysis
Shell	Esso	29/2b	-
Maersk	-	29/8c, 29/12, 29/13, 29/14	Seismic analysis
Antrim	Wham	42/21, 42/22	-
RWEDea	Consort, Egdon	42/26	Acquire 3D seismic
Geosolutions	Sterling Resources	47/1, 47/2b	Acquire 2D seismic
GTO	-	47/6, 47/7 (Part), 47/12, 47/13b	Acquire 2D seismic

Source: [ref 28]

13.2.2 Pipeline and Cables

There are nine active pipelines that will be crossed as a result of the development. For each crossing a 'crossing agreement' has been, or will be established between the owners/operators. The chosen crossing points were confirmed with the third-party owners of the existing cables and pipelines and are detailed in the PWA. In summary, cables crossed by the Langeled pipeline fall into three categories; abandoned, disused and in-use. The North Sea has a number of cables that are not charted, as they have been installed for military purposes. The alignments of such cables are not obtainable from public databases, but a mechanism exists through a specialist consultant for blind checking for conflicts. Langeled is not known to cross any such cables.

13.2.3 Military Activity

Areas of the North Sea are used by the Ministry of Defence (MoD) as practice and exercises grounds 'with or without the use of live ammunition'. The proposed pipeline route will cross two such areas, one Royal Air Force area (D412) and one Royal Navy area (Flamborough Head Submarine Exercise Area), as detailed below.

Table 13.4: Military Activity Areas within the Area Relevant to the Development

Name	Type of Practice	Altitude Range (feet above surface)
Royal Navy (RN) Areas		
Flamborough Head Submarine Exercise Area	Submarine exercise	-
Royal Air Force (RAF) Areas		
D412 Staxton	Air-to-air flying and in-flight re-fuelling	10,000

Source: [ref 27]

The disposal of ordnance in UK waters is no longer undertaken. However, offshore disposal of ordnance occurred in the past with all such historic disposal areas being marked on British Admiralty Charts as *danger areas*. An ordnance contamination risk assessment of an early pipeline route was undertaken at the scoping stage (extending 5 km either side of route) [ref 41]. This concluded that no disused ordnance disposal sites or firing ranges were located in the vicinity of the route. The route passes through the 'World War II east-coast minefields' area that extends along a large expanse of the east coast. The proposed route also crosses the 'World War I 'east-coast barrage' defensive minefield' area. Initial surveys have not indicated the presence of any mines in this area. Records of German-laid field positions are not available. A survey of the final right of way has been not undertaken. As a health and safety requisite the pre-sweep ROV survey will be used to identify ordnance.

13.2.4 Dredging and Dumping

Dumping in the UKCS is prohibited, except under licences issued by DEFRA under Part II of the *Food and Environment Protection Act 1985*. The only exceptions relate to dredged material, fish-processing waste, inert materials of natural origin and vessels or aircraft³⁷. No current or historic licensed dumping areas exist along the route. The nearest dredged areas are located in the mouth of the Humber Estuary (HU080) Humber 1A and (HU090) Humber 2. No active or historic licensed sand and gravel dredging areas are within the anchor spread area.

13.2.5 Shipping

There are a number of ports and harbours located within the study area. The most important are the Humber ports of Hull, Goole, Immingham and Grimsby; therefore, the majority of shipping traffic in the region is likely to be approaching and leaving the Humber estuary. Hull is also a passenger port, with ferry services to Rotterdam and Zeebrugge. The proposed route does not pass through any known anchorage areas, traffic separation schemes, or areas under port authority jurisdiction.

³⁷ This will cease from 2005

13.2.6 Offshore Wind Farms

The UK has significant potential for the generation of electricity from offshore renewable sources such as wind power. In order to assess the potential impacts of wind farm developments on the marine environment, the DTI commissioned a Strategic Environmental Assessment focusing on three strategic regions, one of which was the Greater Wash Strategic Area. The Greater Wash Strategic Area, in which the nearshore section of the route corridor lies, is in Round 2 of the offshore wind licensing programme. Originally, one area coincided with the proposed Langeled route at Westernmost Rough (see Figure 13.2). The Langeled project has investigated alternative routes through this area in order to minimize the impact. However, the Langeled project has selected the route as defined within the PWA for various reasons:

- the wind farm will not be disturbed by the Langeled pipeline as the construction periods do not coincide in time;
- the proposed route has been accepted by the other licensees in the area, namely GTO and Geosolutions;
- alternative routes extend the length of Langeled, thereby adding cost and reducing capacity; and
- the proposed route has been proven to be technically feasible.

This selection has been done in consultation with Total and Crown Estate.

13.2.7 Recreation

This assessment considers leisure and tourism beyond the MLW to the Median Line. Shore-based or inter-tidal activities are considered in the *pipeline landfall* ES. For this reason, and given the nature, of the project, it is unlikely that the area is used for leisure activities, except for sea angling and recreational fishing, sailing and diving. The main water-based leisure and tourism facilities in the east-coast region are listed in the Table below. Based on the most recently complete published data (1995) within the region, there are an estimated 33,000 anglers affiliated to the National Federation of Sea Anglers. Along the east coast, fish are angled recreationally over wrecks off Flamborough Head. Mablethorpe to Sutton-on-Sea, along the Holderness Coast, has good sea-fishing from boat-to-shore.

Table 13.5 Main Water-Based Leisure and Tourism Facilities

Site	Description
East Riding of Yorkshire	
Bridlington	Small Boat Launching, Sailing Club and Pleasure Cruises
River Humber	Five Marinas, and at least three sailing clubs
Lincolnshire	
Chapel St. Leonard's	Launching Over Sand
Jackson's Corner, Ingoldmells	Launching Over Sand
Skegness	Sailing Club

Source: [ref 3]

13.3 Assessment of Impacts

13.3.1 Construction

During the design phase potential interactions between existing activities and the proposed route were resolved through moving the pipeline away from certain critical active licensed blocks and active fields. The baseline data show that the anchor spread area does not encroach on any platform exclusion zones; therefore, the impact potential is considered negligible.

The baseline assessment identifies a number of wells that lie within the anchor spread area and right of way. The owners of wells have been contacted as part of the block crossing process. Third-party acceptance has been obtained from the operators of each well. Where the use of a well is required by a third-party during the construction period, a 500 m exclusion zone, which already exists around any active well in the UKCS, will prevent any vessels, including their anchors, entering such areas. This will be adhered to by the construction team maintaining contact with owners of active wells within the construction corridor to agree on the placement of anchors to avoid damage and reduce operational impact.

The more northern T-Piece (KP 55) is close to an identified pockmark area; however, no such structures were identified along the pipeline route (see Section 7.2.1). It is also situated at the northern limit of a sandeel spawning area (see Section 9.2.2). The second T-piece (KP 150) is not located near or within any sensitive areas. The design of the T-Piece will cause minimal impact on the environment as discussed above. When a connection is made into the Langeled pipeline it will be subject to its own planning requirements.

An assessment of the crossing points has been undertaken in the PWA application and shows there to be no additional structures associated with the cables/pipelines close to the pipeline route. The alignment was also checked for military cable crossings, with no crossings found. Each crossing agreement will provide adequate engineering to minimise the risk of damage to both structures and the environment. The short-term and geographically localised extent of the crossings will minimise these impacts. Where rock dumping is required it will be undertaken using a pipe and consequently the backfill will not pass through the water column. Therefore, rock dumping is not expected to cause adverse impacts to water quality as the material has very low fines content. Any fines present will be inert and will settle to the seabed soon after rock dumping has finished.

The construction of the wind farm will not occur at the same time as the pipeline with likely construction commencing in 2007/2008, at least one year after the intended pipeline construction completion date. Therefore, cumulative construction impacts will not occur.

The nearest licensed dumping/dredging area to the anchor spread corridor (at the mouth of the Humber) is at a sufficient distance so as not to have an impact on the proposed development. Areas where historic unlicensed disposal has occurred have been identified and do not coincide with the proposed route corridor. The extensive surveying of the North Sea means that any such areas are considered to be small in size; therefore, the probability of interfering with the development is minimal.

The risk of ship collision is minimised through implementation of an exclusion zone around the construction site, which will also include the potential anchor spread of the vessels. The supporting anchor tugs will also be used to enforce the exclusion zone. The construction fleet

will be appropriately lit and, in the instance of poor visibility, such as fog, warnings will be sounded. The shipping lanes in the region are suitably deep as to require no maintenance dredging, with any vessel being able to avoid the construction area without placing themselves at risk. Given the intended rate of pipe lay (see section 3) any inconvenience will be minimal. Cumulative effects of passing commercial ships are considered negligible given the short interaction period.

Other users of the sea will be able to actively avoid the construction area without increased risk. The presence of the construction fleet will be made known to all users through the mandatory health and safety requirements discussed above.

Figure 13.2
Areas of Socio-Economic Activity

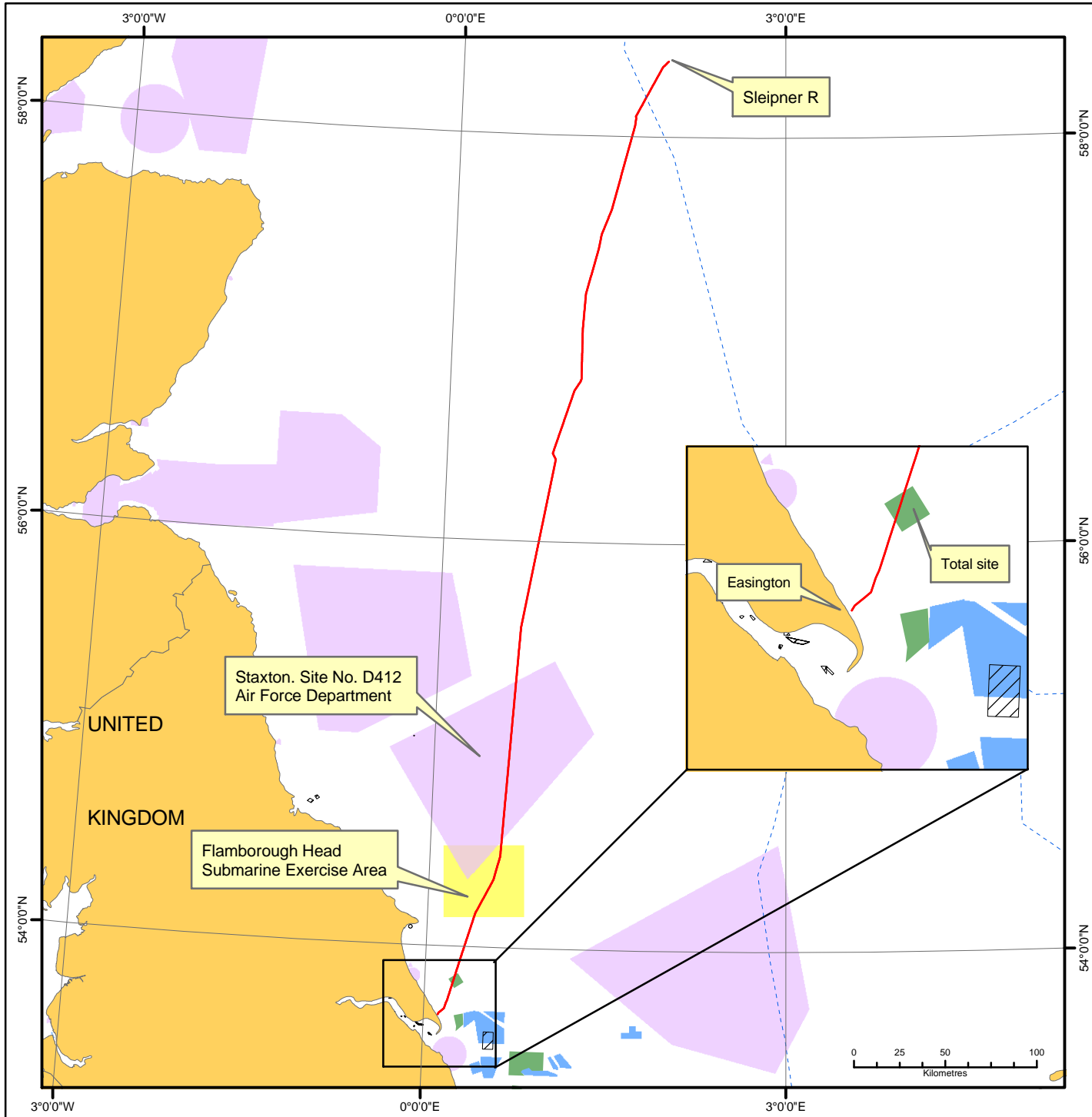

Legend

- Transboundary line
- Southern pipeline system
- Land
- Windfarm areas (round 1&2)
- Dumpsites
- Military exercise area
- Aggregate extraction area
- Submarine exercise area

© Metoc plc, Data Licence 052003.005. All Rights Reserved.
NOT TO BE USED FOR NAVIGATION

Date	12/March/2004	
Projection	UTM Zone 31N	
Spheroid	International 1924	
Datum	ED 50	
Data Source	Metoc Charts, Statoil,	
File Reference	I://.P517/GIS/AvProj/P517- socioeco areas.mxd	
Checked	Jillian Barnes	GIS Specialist
	Philip Wemyss	Project Manager



13.3.2 Operation

The presence of the Langeled pipeline will not have any significant effects during operation. Its location will be plotted on Kingfisher admiralty charts³⁸; therefore, no operational impacts are predicted. The pipeline will be consistent with other linear seabed infrastructure in the North Sea. There maybe some potential for impacts during the construction of the proposed wind farm. However, the potential impacts will be minimised with the wind farm site avoiding the pipeline corridor and it will be subject to its own ES.

³⁸ Kingfisher are the UK body who are responsible for charting all infrastructure on admiralty charts.

14 ASSESSMENT FINDINGS

This section draws together the findings of the *marine pipeline* ES and the mitigation/monitoring measures that will be used to remedy any identified impacts. It also summarises the residual impacts remaining after the implementation of the mitigation measures. The mitigation/monitoring measures described form the schedule included in section 15, which form the basis of the project's Environmental Management Plan (EMP)

14.1 Physical Environment

For the majority of the route the thick layer of mobile fine surface sediments ensures that natural backfilling will rapidly occur after any seabed intervention works, including anchoring. However, there still remain certain areas where mechanical backfilling is required, which have been identified prior to construction. In these areas the time between dredging/trenching and backfilling will be as short as possible to reduce the time for natural dispersion of the sediment; thus, conserving a maximum amount of the material for backfilling. When excavating the floating channel and cofferdam material will be placed on the southern, or the *down current*, side. Although sand movement to the north does occur from time to time, this placement will minimise the amount of spoil moving back into the trench before the pipe-laying is complete. In areas where very-soft-to-soft sediments are found (KP 30 – KP 361), there is a possibility that, over time, spanning may occur. Any spans that periodically form will therefore be considerably less than the critical height of 0.75/0.80 m. Between KP 451 and KP 521 pre-sweeping of the sandwaves high-spots will also ensure that no spanning occurs over the critical height. Hard substrates are largely immobile, so will act as a stabilising element for the pipeline. Where intervention work will be carried out from KP 486 to KP 528; erosion of the hard cohesive deposits (Bolders Bank Formation) will provide some coarser, less mobile sediment around the pipeline. The bedrock area has been avoided during the route realignment stage.

Sediment transport across the offshore platform (KP 521-KP 538) is patchy and in the form of sand patches and sand ribbons. This action of intermittent sand movement will be approximately mimicked by the disturbance caused by seabed intervention operations. After the construction works are complete, natural backfilling of any remaining voids will occur. It is recognised this will happen in a patchy fashion at first, and may depend on the position, and relative mobility, of any close, upstream, large volume sandbody. Beyond KP 521 the seabed intervention works will result in only a comparatively small loss of sediments compared to naturally derived volumes. Any losses will be minimised through planning the works over as short a period of time as is practical. Only the finer fractions will be dispersed as suspension load and they will become part of the eastward moving East Anglian Plume. The coarsest fractions (gravel-to-boulders) are expected to remain close to the trench.

The 'Lagoons', Spurn Spit and Spurn Head areas are dependent on a natural supply of sand and shingle for their continued maintenance. The dredged/trenched corridor will be backfilled mechanically and/or naturally with the excavated material. Dredging activity within the region of the nearshore platform will disturb approximately 11,000 m³ of the c.850,000 m³ of coarse sediments annually supplied by nearshore platform for natural backfilling; if some of the trenched material is still available at the time. This equates to 1.3 %. It is not considered that this small reduction in quantity over one year will adversely affect the stability of either the Lagoons or the Spit. Naturally eroded fine-grained sediment from the nearshore platform (c.2.20 million m³) will move in suspension or semi-suspended load (mostly during the autumn

and winter) and will not be affected by dredging, pipe-laying and backfilling operations. It is, therefore, considered that there will be a negligible impact on the environment.

In all instances intervention work will only be undertaken for technical and safety reasons, specifically to secure pipeline stability and to a lesser extent to avoid freespan. However, the removal, reworking and deposition of excavated material on the seabed in a disaggregated (mixed up) manner has the potential to result in a short-term localised loss and/or alteration in biological community. The potential is heightened in the region close to the shore where the floating channel and cofferdam are being constructed. The effects are, however, considered to be short-term and a low significance.

Mounds and scars produced by the anchors from the pipe-lay barges will form a pattern along the length of the pipeline route. The size of these mounds and scars will vary with vessel type, the local geological profile into which the anchor is being placed, the anchor configuration and the water depth. Furthermore, the anchor wires may also drag on the seabed. Nearshore, the highly dynamic waters will quickly remove any mounds and scars that are created in the upper finer sediments, with the area being reinstated within the short-to-medium term. It is therefore, considered that the significance of the project will be low.

In other areas, where the scar/mounds are more prominent, any finer sediments will be washed away exposing the harder and or coarser sediments. This is especially true of clay areas. Here, the seabed may be subjected to remediation, through the use of such techniques as chain drags from fishing boats. Chaining of the seabed will be limited and only used as a mitigation measure where the mounds pose a significant risk of hooking in important trawl areas. Post-installation surveying of the route will be undertaken to assess the condition of the seabed. Lay barges that avoid the use of anchors through dynamic positioning were considered; however, no vessels of a sufficient size were available. The lay barges to be used, LB200 and Tug Mor, both use delta flipper anchors, which design reduces dragging along the seabed and minimise scars. It is considered that the project will have a low significance on the physical environment.

14.2 Conservation Areas

The route selection process focussed on avoiding areas highlighted as potential area that could contain species listed in UK Habitat's Directive (known as potential Annex I Habitat Areas), which has been confirmed through the extensive survey work undertaken. The potential for impacts is; therefore, minimised and the requirement for mitigation removed. No impacts on coastal protected areas are envisaged.

14.3 Benthic Ecology

Between KP 23 and KP 521 the effects of the intervention works will be short-term as the metocean conditions and sediment type allow for rapid recovery, which has been demonstrated through other studies. Furthermore, communities of such unconsolidated sandy habitats are likely to show tolerance to disturbance and have relatively fast recovery rates [ref 20].

For the remainder of the route from KP 521 to KP 543, given the required burial depth (up to 6 m), combined with the underlying geology, impacts are potentially more significant, leading to localised losses and indirect smothering. However, these impacts will be short-term, and given that the development footprint represents a very small area compared to the whole habitat, as well as the natural dynamics of these areas, the overall risk is low. A high level of

recolonisation is also expected. Nonetheless, to minimise impacts within this area, the intervention methods have been carefully selected.

The cutter suction dredger will generate localised increases in turbidity. However, the suction pump will ensure that most of the material is sucked into the vessels, rather than creating the large volume of suspended material. The use of a plough, which is gentler than the alternative of jetting, and a dredging hose to reinstate the landfall approach area, means that impacts will be reduced. The dredged material will be temporally placed to the southerly side of the channel to minimise natural backfill of the trench/channel and to reduce the damage to the existing benthic environment. Further offshore, remediation work by means of mechanical backfilling, will be restricted to areas where the spoil is too dense (e.g. boulders and cobbles) or too stiff (e.g. clays) to allow backfilling by natural processes.

The areas of rock dumping that will suffer small-scale disturbance, direct mortality of sessile species, loss of original habitat and creation of alternative habitat due to the addition of a new hard substrate in the form of the pipeline itself. Smothering by settlement of the suspended sediments in the close vicinity to the works will occur and may lead to the loss of sessile and more fragile species. Nonetheless, this activity will be kept to a minimum and will only occur in areas that require the additional material for safety reasons, and is therefore, considered to be insignificant.

Construction and reinstatement of the cofferdam and floating channel will destroy any community structure within the area. However, the communities in this landfall region extend over large areas of the North Sea and are generally adapted to a dynamic environment; therefore, impacts are not expected to be significant as the works are confined to a comparatively small area. The affected area will rapidly recolonise as is demonstrated through the presence of five other pipelines that landfall at Easington. It is, therefore, considered that the significance of the project on the benthic environment is low.

14.4 Fish and Shellfish

The most sensitive period for fish species (particularly for the demersal species) and shellfish, will be during the spawning months, specifically May-to-September, and to a lesser extent the nursery periods, which are approximately three months later. This includes part of the most sensitive period for herring spawning. However, given the scale and size of the development, it is impossible to avoid construction work during these periods. The effects of construction relate to the loss or alteration of habitat, species moving out of their spawning and nursery grounds, and the indirect effects of smothering through the various intervention works. However in all instances, the associated impacts are not expected to be significant as the works will only directly affect each species for part of their spawning/nursing period for one year. The exception is in the cofferdam and floating channel area where, given the prolonged period of work, the impacts may be more significant. However, direct effects beyond one or two years are considered unlikely. The magnitude of any impact is lessened as the total intervention work is confined to a small area in relation to any entire ground (0.04 % maximum) with metocean condition rapidly re-dispersing any smothering sediments. The significance of the development on fish is therefore low.

14.5 Fisheries

The main areas of direct concern relate to: overtrawlability, in particular related to spanning, and the exclusion zones (primarily in the nearshore area). Indirect effects relate to habitat removal (including the clay huts close to the shore), disturbance, and smothering. Offshore pipelaying and the required intervention works coincide with regions of intense fishing activity and are planned to occur, in some instances, in peak fishing season. For the majority of the route to KP 520, September 2005 will be the only month where there is such a conflict between construction activity and trawling (including trawled-gear Scottish seining, mid-water trawling (both pair and single forms and small-meshed trawl gears). However, given that the offshore construction vessels (LB200) will be constantly moving (up to 4 km per day) trawl vessels will be able to avoid the temporary exclusion area around the vessel without disruption to their fishing activity.

Up to the MLW mark the construction works occur concurrently with peak fishing activity for a period of up to 6 months. Concerns relate to increased turbidity and smothering and the associated effects on sheltering lobster and the clogging of fishing pots. However, the metocean conditions close to the landfall are sufficient to allow the exposed clay fines to be transported out of the area by the prevailing currents, whilst the coarser material will settle out in close range of the dredged or trenched area, which reduces any adverse effects. The transported sediments will rapidly disperse; limiting the impact on other areas. Another effect is that all pots will have to be removed in advance of the pipelaying barge, which for a period of time, will force boats to pot in areas to the north and south of the development area. A temporary exclusion zone of 1 Km width is needed to facilitate construction in the nearshore area. This may force fishing vessels into areas that are already intensively fished and, as such, could have secondary effects on earnings during these periods; but, no long lasting effects are anticipated. This exclusion zone may also impinge on vessels launching from Easington.

However, in all instances, the associated impacts are not expected to be significant as any intervention work will be confined to a small area in relation to the entire ground and will only directly affect fishing activity for part of any season for one year. It is likely that beyond any single season no direct effects from the Langed development will be apparent. Indirect effects following burial of the pipeline and the associated natural and mechanical backfilling are likely to extend beyond any direct effects. However, their magnitude will be significantly less than the initial work as mobile scavenger species, such as crabs and lobsters, are likely to rapidly re-colonise the areas, feeding on any biological material exposed by the disturbances.

In the region of clay huts (between KP 542 to KP 543) there will be unavoidable disturbance to the seabed that will result in key lobster habitat loss. Presently, it is believed that the construction works will reduce the quality of the habitat for lobsters and may have associated secondary impacts on economic value of the ground within the affected corridor. The works in this region will coincide with part of the peak lobster season. However, there are five existing pipelines that pass through the clay hummocks within 1.5 km of the proposed pipeline. They have all created similar levels of disturbance during installation; however, do not appear to have significantly affected the lobster fishery over the long-term. To address these data gaps, a baseline survey will be undertaken prior to construction to establish lobster densities in the dredged corridor. This can be used to compare densities after the pipeline is installed. The method will be established through consultations with the NESFC and CEFAS to ensure appropriate codes of scientific practice are employed with the results being issued to local fishermen.

High spots on the seabed along the route will be removed by pre-sweeping and the pipeline will be sufficiently trenched to prevent spanning. Where the pipeline will remain on the seabed, previous data from trawl testing on similar pipelines with diameters up to 42 proves that the risk of snagging and spanning is minimal. The Scottish and English fishing organisations (SFF and NFFO) have been consulted regarding this issue and both parties felt that new trawl-tests are required. The Langeled Project team has agreed that trawl tests will be carried out shortly after pipelaying. The tests will involve different types of trawl gear, and will be carried out in cooperation with SFF, NFFO and relevant fishery research institutions. The significance of the project on fisheries is low to moderate. A lobster survey and over-trawlability survey are to be conducted to establish the extent of any potential damage.

14.6 Marine Archaeology

From KP 23 through to KP 517 there is very limited potential for the development to affect unknown archaeological materials. Therefore, no active mitigation measures are suggested. Within this region, all known wrecks will be avoided. From KP 517 to MLW, the excavation is sufficiently shallow for effects to be limited to sediments from the Late Upper Palaeolithic and Mesolithic epoch. The baseline assessment suggests that the presence of artefacts, organic deposits and eroded terrestrial sites is limited; however, any items found could be potentially important. It is considered that the potential impact on archaeology is negligible.

14.7 Socio-Economic Activity (Other than Fisheries)

The route selection process has avoided areas where significant impacts could occur. However, there are three aspects that could not be avoided. These are existing wells, pipelines/cables crossings and shipping lanes. Within the pipeline corridor, where a well is either active or has the potential to be re-entered, liaison with the well owners/operators has been undertaken. Within the anchor corridor each anchor will be located at a distance greater than 500 m from any well head to minimise the risk of well damage. All crossings have been designed to be overtrawlable. The exclusions zone around the construction fleet nearshore will be marked through the use of buoys; and the all vessels will be appropriately lit, and in the instance of poor visibility, such as fog, warnings will be sounded. Notification to seafarers will be issued as appropriate.

14.8 Residual Impacts

Residual impacts are those that remain after the implementation of mitigation measures. The only unavoidable residual impact will be on benthic communities, fish and shellfish resulting from the actual long-term presence of the pipeline and crossing structures. However, these impacts will be local to the pipeline itself, which represents a negligible percentage of the total area of these communities and therefore is considered insignificant.

14.9 Cumulative and Transboundary Impacts

There are no significant cumulative impacts anticipated from the proposed development. We are not aware of any other major existing or planned development works during the construction period that fall in sufficiently close proximity to the Langeled Pipeline to lead to notable cumulative effects. Activities associated with other anthropogenic activities on the UKCS are all sufficiently distant from the main development footprint for cumulative impacts not to be of concern.

As shown in Section 4.3 there will be negligible transboundary environmental impact associated with the installation and operation of the Langeled pipeline within region covered by this document as described in this ES.

15 ENVIRONMENTAL MANAGEMENT

The Statoil Group's Environmental Policy supports the goals of zero harm to the environment and sustainable development³⁹. The policy applies to the design and operation of plant and to the products and services provided to the end-user. The Statoil Group's Environmental Policy is as follows.

- "We will act according to the precautionary principle.
- We will minimise impact on the environment, whilst continuing to address health, safety and economic issues.
- We will comply with applicable legislations and regulations.
- We will continuously improve our energy efficiency, environmental performance and products.
- We will set specific targets and improvement measures based on relevant knowledge of the area affected, and by applying risk analyses to assess environmental and health effects.
- We will consult and cooperate with relevant stakeholders and strive for solutions acceptable to all affected parties.
- We will make our policy available to the public, openly report our performance and use a competent and independent body to verify our reported data.
- We will seek to make the best possible utilisation and use of natural resources.
- We will contribute to the reduction of Green House Gases (GHG) by reducing relevant emissions from our activities and by participating in emission trading and utilising project based mechanisms.
- We will prepare for a carbon constrained energy market and engage in the development of non-fossil energy sources and carriers".

Requirements for managing activities and processes in Statoil within the HSE⁴⁰ area are specified in the document 'HSE Management in Statoil (AR21)'. HSE activities and processes form an integral part of the business, of commercial planning and of decision-making processes. Responsibility for ensuring this and for documenting it to the necessary extent rests with the line organisation. Statoil require that all entities must have established and documented appropriate systems, which determine that HSE requirements are met.

The above objectives will ensure that all mitigation commitments within this statement are effectively implemented, measured and controlled, whereby any evidence of non-conformance will be addressed through appropriate corrective action. This will be controlled through a resolute reporting structure amongst all parties involved with the development in the marine environment.

A copy of the Statoil HSE poster is shown below.

³⁹ Sustainable development is a development that meets present needs without reducing opportunities for coming generations to fulfil their own needs.

⁴⁰ HSE is an abbreviation for "health, safety and the environment" and embraces the categories of health and the working environment, the external environment, security, safety and emergency response.

HSE

Our objectives in health, safety and the environment:

- ***zero harm to people or the environment***
- ***zero accidents or losses***

- **A high performance in HSE has a value in itself. It is also a prerequisite for positive financial results and a good reputation.**
- **We will contribute to sustainable development.**
- **We apply the same attitudes towards HSE wherever we do business.**
- **We expect our suppliers and partners to share our values and objectives.**

You and I have a common responsibility to care for the environment, our values and each other!



Olav Fjell
President and CEO



15.1 Project Environmental Management Plan

The Environmental Management Plan (EMP) will be a key part of the system for implementing the Company Policies and commitments made within the ES during the construction of the *marine pipeline*.

The main objectives of the EMP will be to:

- ensure compliance with legislation, Codes of Practice and Regulations;
- ensure compliance with any conditions set by the local planning authority, or other consent granting bodies;
- ensure compliance with the Statoil group's environmental policy; and
- ensure implementation of the mitigation measures identified in the EIA process.

In addition, the EMP will address:

- contingencies for unforeseen events;
- roles for Langeled and Contractor staff;
- briefing of personnel in terms of such matters as environmental awareness;
- monitoring, watching briefs and audit of construction works; and
- restoration, aftercare and post-completion inspections.

15.2 Schedule of Mitigation/Monitoring Measures

The Table below presents a schedule of mitigation/monitoring measures which the Project Team have committed to implement, but for which the details may still have to be finalised. These measures will be incorporated into the EMP, which will be implemented prior to the start of construction. Some of the measures listed in the Table 15.1 will require further consultation with relevant parties before they are finalised.

Table 15.1 – Mitigation/Monitoring Measures

Aspect	Environmental Impact	Mitigation/Monitoring
Physical Environment	Changes to sediment transport and seabed condition	The time period between seabed intervention works, pipelaying and backfilling will be kept to a minimum. Excavated material will be placed on the southern down current side within the 200m working corridor authorised by PWA
	Potential spanning of the pipeline	The pipeline will be sufficiently trenched to prevent spanning. Post installation surveying of the route will be undertaken to assess the condition of the seabed and any remediation will be undertaken if necessary.
	Creation and exposure of hard mounds and scars post-anchoring	Where there is a significant risk, post-lay intervention work will be undertaken, either through chain drags. Delta flipper anchors will be used, and specific anchor handling procedures will be established in order to reduce potential dragging along the seabed and minimise scars.
Atmospheric Emissions	Release of exhaust gasses (SO ₂ , NO _x etc.)	Regular maintenance programmes will be implemented to ensure emission standards are maintained.
Benthic Ecology - Fish and Shellfish	Direct mortality of benthic species, moulting individuals, and juveniles (including the indirect effects of smothering) notably sessile species, habitat loss, and potential small-scale changes in community structure.	The cutter suction dredger will pump the dredged spoil through a floating pipe directly to the deposit location. In the floating channel 75% of the material will be deposited in the area of the floating channel thereby reducing impacts on benthic organism.

Aspect	Environmental Impact	Mitigation/Monitoring
		<p>Matrassing and rock dumping will be kept to a minimum, and will only be used where it is required for technical and safety reasons.</p> <p>Construction works has been scheduled to avoid spawning and nursery periods where possible.</p>
Seabirds	Potential affects of very small-scale oil spill from vessels on sea birds.	The project environmental management plan will include measures to prevent and control of oil discharges to the sea.
Commercial Fishing	<p>Affects on fishing activity through the creation of an exclusion zone</p> <p>Displacement of vessels outside of the nearshore exclusion zone during construction</p> <p>Uncertainty expressed by SFF and NFFO on whether it will be possible to trawl across the pipeline</p> <p>The risk of snagging on anchor mounds shortly after pipelaying.</p>	<p>Guard vessels will operate in the construction area to ensure that the safety of other vessels operating in the vicinity is not compromised. The exclusion zone will be clearly marked close to the Easington landfall.</p> <p>Service agreements will be established to provide support in communicating with and informing the fishermen operating along the pipeline route, and ensure that each party is fully aware of the activities taking place; therefore, avoiding conflict of interests during the construction phase.</p> <p>Under the Petroleum Act (1998) “<i>appropriate Fishing Organisation be informed every twenty-four hours of the position at which construction works is to be carried out during the preceding twenty-four hours and on the following three days. Radio broadcasts be made from the installation vessel twice-daily</i>”.</p> <p>Liaison with relevant parties to ensure that issues and concerns raised are heard and addressed where possible.</p> <p>Compensation for the loss of earnings associated with the disruption caused by the project will be offered where the loss is reasonably documented.</p> <p>Trawl tests will be carried out shortly after pipelaying. The tests will involve different types of trawl gear, and will be carried out in cooperation with SFF, NFFO and relevant fishery research institutions.</p> <p>Surveys will be made in areas where anchor mounds may be a potential problem for trawling (important trawl areas on clay bottom), and agreements will be established with SFF and NFFO to level off anchor mounds by dragging chains over the mounds where that is considered to be necessary for safety reasons.</p>
Shipping	Direct severance of shipping lanes.	The exclusions area around the construction fleet will be marked in critical areas through the use of buoys and the all vessels will be appropriately lit, and in the instance of poor visibility, such as fog, warnings will be sounded. Notification to seafarers will be issued as needed and the fleet will be ‘guard’ the construction zone.

16 REFERENCES

PUBLICATIONS

- 1 Arveson, P., Vendittis, D., (2000) Radiated noise characteristics of a modern cargo ship, *Journal of the Acoustical Society of America*, 107(1), 118-129.
- 2 Balson P.S, Tragheim D & Newsham R. (1998). Determination and prediction of sediment Yields from recession of the Holderness coast, eastern England. Proc. 33rd MAFF, Conf. River and Coastal Eng. 4.5.1 – 4.5.11.
- 3 Barne J.H, Robson C.F, Kaznowska J.P, Doody J.P, & Davidson N.C (1995). Coasts and Seas of the United Kingdom. Region 6 Eastern England: Flamborough Head to Great Yarmouth. JNCC (1995).
- 4 Barrett, R.W. (ed.). (1996). Guidelines for the safe use of explosives underwater. MTD Publication 96/101. Marine Technology Directorate. ISBN 1 870553 23 3.
- 5 Bennett D.B and Brown C.G (1983). Crab (*Cancer pagurus*) migrations in the English Channel. *J. mar.bio.Ass.UK.* Vol.63. p.371-398
- 6 Betts, S, et al. 2003. Geotechnical Report Soil Parameters, Laboratory Testing and in-situ Data. OLT Pipeline – Easington Landfall. Fugro Limited.
- 7 Bergman M.J.N. & Hup M. (1992) Direct effects of beam trawling on macro-fauna in a sandy sediment in the southern North Sea ICES Journal of Marine Science. 49:5-11
- 8 BG International, Amerada Hess, Amoco (UK) Exploration Company. (2001). The Juno Project. Environmental Statement.
- 9 Survey. (2002). Technical Report TR 008 Rev1. North Sea Geology.
- 10 BP Amoco Exploration, (1999). Environmental Statement: West Sole Pipeline Stabilisation Works.
- 11 BP, (2002). Noise measurements during Pipelaying Operations Around the Shetland Islands for the Magnus EOR project.
- 12 British Geological Survey (BGS), 1: 250,000 map series – Seabed Sediments and Quaternary Sheets, 53° - 58°N - 00°: for Spurn, California, Swallow Hole, Devil's Hole, Forties/Cod.
- 13 British Geological Survey. (2002). Technical Report TR 008 Rev1. North Sea Geology.
- 14 Callaway, R., Alsvag, J., de Boois, I., Cotter, J., Ford, A., Hinz, A., Jennings, S., Kronke, I., Lancaster, J., Piet, G., Prince, P., and Ehrich, S. (2002). Diversity and community structure of epibenthic invertebrates and fish in the North Sea. *ICES Journal of Marine Science*. 59: 1199-1214. 2002.
- 15 Cameron, T.D.J, et al. (1992). The Geology of the Southern North Sea. British Geological Survey, United Kingdom Offshore Report.
- 16 CEFAS, (2001). Shellfish News. No. 12, November 2001. CEFAS.
- 17 Crisp, DJ (ed.), 1964a. The effects of the severe winter of 1962-63 on marine life in Britain. *Journal of Animal Ecology*, 33, 165-210.
- 18 Coles, B. (1998). Doggerland: a Speculative Survey. *Proceedings of the Prehistoric Society* 64.
- 19 Coles, J, et al. (1993). A spirit of Enquiry: Essays for Ted Wright. Wetland Archaeology Research Project, Nautical Archaeology Society, National Maritime Museum.
- 20 Collie, J.S, Escanero, G.A. and Valentine, P.C.(2000) Photographic evaluation of the impacts of bottom fishing on benthic epifauna. *ICES Journal of Marine Science* 57(4) Page(s) 987-1001
- 21 Conoco, (2001). Environmental Statement for the CMS III development in Quadrant 44. March 2001. Conoco (U.K) Limited.
- 22 Cotterel, T, et al. (2003). A proposed Pipeline Landfall and Gas Reception Facilities site at Dimlington, Easington, in the East Riding of Yorkshire. Archaeological Assessment, AC Archaeology.
- 23 Coull, K. A. , Johnstone, R. , and Rogers, S. I. (1998). Fisheries Sensitivity Maps for British Waters. Published and distributed by UKOOA.
- 24 Cox, J.M (2001). Report on mineralogical tracers for the Southern North Sea Sediment Transport Study. CEFAS Report.
- 25 Davis, R.A., Thompson, D.H., Malme, C.L., (1998); Environmental Assessment of Seismic Exploration on the Scotian Shelf, LGL Limited for Mobile Oil Canada Properties Limited.
- 26 Department of Trade and Industry (2001). Strategic Environmental Assessment of the Mature Areas of the Offshore North Sea SEA 2. Consultation Document, September 2001 [Also including all Technical Appendices].
- 27 Department of Trade and Industry (2002). Strategic Environmental Assessment of Parts of the Central & Southern North Sea SEA3. Consultation Document, August 2002 [Also including all Technical Appendices].
- 28 Department of Trade and Industry (2004): Development of the Oil and Gas Resources of the United Kingdom, H.M.S.O., London.
- 29 Dernie, K.M, Kaiser, M.J., Richardson, E.A. and Warwick, R.M. (2003) Recovery of soft sediment communities and habitats following physical disturbance. *Journal of Experimental Marine Biology and Ecology* 285-286 Page(s) 415-434
- 30 Duineveld, G. C. A., Eleftheriou, A., Heip, C., Herman, P., Kingston, P., Nierman, U., Rachor, E., Kingston.P., Niermann.U., Rachor.E., Rumohr.H. and de Wilde, P.A.J. (1992). The benthic infauna of the North Sea: species distribution and assemblages. *ICES Journal of Marine Science*. 49. pg 127-143.
- 31 Dyer K.R and Moffat T.J (1998). Fluxes of suspended matter in the East Anglian plume, Southern North Sea. *Continental Shelf Research*. 18. 1311-1331.
- 32 Dyer M.F, Fry W.G, Fry P.D, and Cranmer G.J (1983). Benthic regions within the North Sea. *Journal of Marine Biological Association UK*. 63. pg 683-693.
- 33 Eleftheriou A, and Robertson M.R (1992). The effects of experimental scallop dredging on the fauna and physical environment of a shallow sandy community. *Netherlands Journal of Sea Research*. 30: 289-299.
- 34 Eleftheriou A and Basford D.J (1989). The macrobenthic infauna of the offshore northern North Sea. *Journal of Marine Biological Association UK*. 69. pg 123-143. English Channel. *J. mar.bio.Ass.UK.* Vol.63. p.371-398.
- 35 Ellis D. & Heim, C., 1985. Submersible surveys of benthos near a turbidity cloud. *Marine Pollution Bulletin*, 16(5), 197-203.
- 36

- 37 English Heritage and the Royal Commission on the Historical Monuments of England (RCHME) (1996). England's Coastal Heritage: a Statement on the Management of Coastal Archaeology.
- 38 English Heritage. (1998). Identifying and Protecting Palaeolithic Remains: Archaeological Guidance for Planning Authorities and Developers.
- 39 Enterprise Oil plc. (1999). Repeat post-drill survey. Neilson field. UKCS 22/11 and 22/6.
- 40 Evans, D.H. 2001. An East Riding Miscellany. East Riding Archaeologist Volume 10.
- 41 Fellows International Limited (2002) A Risk Assessment of Unexploded Munitions File 1.5/95-01
- 42 Fugro Technical Report. (2003). Geotechnical parameters, soil conditions of OLT Pipeline – Easington Landfall. Report 33315-2.
- 43 Gales, R.S. (1982): Effects of noise of offshore oil and gas operations on marine mammals - an introductory assessment. NOSC Technical Report 844 to the US Bureau of Land Management. 333pp.
- 44 Gibbard, P.L. (1988). The history of the great northwest European rivers during the last three million years. Phil. Trans. Roy. Soc. Lond. B318, 559-602.
- 45 Gaz de France Britain Limited, (2002). Monroe Block 44/17b Exploration Well 2003, Environmental Statement. Revision:01, October 2002.
- 46 Goold, J.C. & Fish, P.J. (1998). Broadband spectra of seismic survey air-gun emissions, with reference to dolphin auditory thresholds., J. Acoust. Soc. Am., 103(4), 2177-2184. [There is also a comment by Ridgway, S. H., et al. on this paper in J. Acoust. Soc. Am., 105(3), 2047-2048, and a reply to that comment by Goold & Fish in J. Acoust. Soc. Am., 105(3), 2049-2050].
- 47 Gray, M.J (1995). The coastal fisheries of England and Wales, Part III: A review of their status 1992-1994. Fisheries Research Technical Report No. 100. Directorate of Fisheries Research, Lowestoft, 1995.
- 48 H.R Wallingford, D'Olier B, CEFAS/UEA., Posford Haskoning. (2002). Southern North Sea Sediment Transport Study, Phase 2. Report EX4526.
- 49 Hall A.J, Watkins J, Hammond P.S (1998). Seasonal variation in the diet of harbour seals in the south-western North Sea. Marine Ecological Progress Series Vol.170. p.269-281.
- 50 Hall S.J, (1994). Physical disturbance and marine benthic communities: life in unconsolidated sediments. Oceanography and Marine Biology: an Annual Review. 32: 179-239.
- 51 Hall, J. D. & Francine, J. (1991). Measurements of underwater sounds from a concrete island drilling structure located in the Alaskan sector of the Beaufort Sea., J. Acoust. Soc. Am., 90(3), 1665-1667. [Also references Greene, C. R. (1987). Characteristics of oil industry dredge and
- 52 Hansjorg, S. (2003). Sedimentary record of Pleistocene and Holocene marine inundations along the North Sea coast of Lower Saxony, Germany. Quaternary International 112 (2004).
- 53 Hayward, P.J., Nelson-Smith, T., Shields, C. (1996). Sea Shore of Britain & Europe. Collins pocket guide. HarperCollins Publishers Ltd, 1996.
- 54 Heriot-Watt University (2001). An analysis of U.K Offshore Oil and gas Environmental Surveys 1975-95. At the request of the United Kingdom Offshore Operators Association.
- 55 Hill, J.M., (2003). Nephrops norvegicus. Norway lobster. Marine Life Information Network: Biology and Sensitivity Key Information Sub-programme [on-line]. Plymouth: Marine Biological Association of the United Kingdom. [cited 11/08/03]. Available from: <http://www.marlin.ac.uk/species/Nepnor.htm>.
- 56 Hodges, R. (1982). Dark Age Economies. Duckworth.
- 57 Holmes, R. (1997). Quaternary stratigraphy: the offshore record: Chapter 7. In: Gordon, J.E. (Ed) Reflections on the ice age in Scotland: an update on Quaternary studies. Scottish Natural Heritage. ISBN 0 9524210.
- 58 Housley, R.A., Gamble, C.S., Street, M. & Pettitt, P. (1997) 'Radiocarbon evidence for the Late-glacial human re-colonisation of northern Europe' Proceedings of the Prehistoric Society 63.
- 59 Hovland, M. (2004). Personal communications regarding the presence of pockmarks. 01/03/2004
- 60 Hull University. (1991). Atwick. Benthic survey data on behalf of British Gas.
- 61 Hull University. (1992). Easington. Benthic survey data on behalf of British Gas.
- 62 Hull University. (1998). Easington. Benthic survey data on behalf of British Gas.
- 63 Institute of Field Archaeologists (IFA) (1999) Standard and Guidance for Archaeological Desk-based Assessment.
- 64 Jackson, A., & Hiscock, K. (2003). Sabellaria spinulosa. Ross worm. Marine life Information Network: Biology and Sensitivity Key Information Sub-programme [on-line]. Plymouth: Marine Biological Association of the United Kingdom. [cited 02/03/2004]. Available from: <http://www.marlin.ac.uk/species/Sabspi.htm>.
- 65 Jelgersma, S. (1979). . Sea-level changes in the North Sea Basin. Pp 233 – 248. In: Oele, E et al. (eds) The Quaternary History of the North Sea. Acta Universitatis Upsaliensis: Symposium Universitatis Upsaliensis Annum Quingentesimum Celebrantis. 2.
- 66 Jennings S, Lancaster J, Woolmer A and Cotter J (1999). Distribution, diversity and abundance of epibenthic fauna in the North Sea. Journal of Marine Biological Association UK. 79. p 385-399.
- 67 Joint Nature Conservation Committee, (1998). Seabird vulnerability in UK Waters: Block specific vulnerability. JNCC Aberdeen.
- 68 Johnston et al., (2002). Natura 2000 in UK Offshore Waters: Advice to support the implementation of the EC Habitats and Birds Directives in UK offshore waters. JNCC Report 325.
- 69 Judd, G. (2001). Pockmarks in the UK sector of the North Sea. Technical report TR_002, produced for Strategic Environmental Assessment – SEA2. DTI.
- 70 Kaiser, M.J., Edwards, B.D., Armstrong, P.J., Radford, K., Lough, N.E.L., Flatt, R.P., and Jones. (1998). Changes in megafaunal benthic communities in different habitats after trawling disturbance. ICES Journal of Marine Science. 55: 353-361.
- 71 Kenny A.J. & Rees H.L (1996). The effects of marine gravel extraction on the macrobenthos: results 2 years post-dredging. Marine Pollution Bulletin. 32: 615-622.

- 72 Kröncke, I., Lancaster, J., Piet, G., Prince, P. and Ehrich, D.(2002). Diversity and community structure of epibenthic invertebrates and fish in the North Sea. *ICES Journal of Marine Sciences*. 59. 1199-1214.
- 73 Künitzer A et al. (1992). The benthic infauna of the North Sea: species distribution and assemblages. *ICES Journal of Marine Science*. 49. pg 127-143.
- 74 Lambeck, K. (1995). Late Devensian and Holocene shorelines of the British Isles and North Sea from models of glacio-hydro-isostatic rebound. *Journ. Geol. Soc. Lond.* 152, 437–448.
- 75 Larn, R. and Larn, B. (1994). *Shipwreck Index of the British Isles Vol. 3*.
- 76 Lawson, J.W. (1999). Seismic program described. In Richardson, W.J. (ed.). *Marine mammal and acoustical monitoring of Western Geophysical's open-water seismic program in the Alaskan Beaufort Sea, 1998*, pp.2-1 to 2-25. Report from LGL Ltd., King City, Ont., and Greenridge Sciences Inc., Santa Barbara, CA, for Western Geophysical, Houston, TX. and Nat. Mar. Fish. Serv., Anchorage, AK, and Silver Leggett D.J et al. (1998). Beach evolution on the southern North Sea Coast. *Coastal Eng.* 2759- 2772.
- 78 Linnane, A., Mazzoni, D., Mercer, J.P. (2000). A long-term mesocosm study on the settlement and survival of juvenile European lobster *Homarus gammarus* L. in four natural substrates, *Journal of Experimental Marine Biology and Ecology*. 249: 51-64.
- 79 Loo, L.-O., Baden, S.P., Ulmestrand, M., (1993). Suspension feeding in adult *Nephrops norvegicus* (L.) and *Homarus gammarus* (L.) (Decapoda). *Netherlands Journal of Sea Research*. 31 (3): 291-297 (1993).
- 80 M^cCave I.N (1987). Fine sediment sources and sinks around the East Anglian Coast. *Journal of the Geological Society London*. 144, 149-152.
- 81 M^cGrail, S. (1987). *Ancient Boats in North-West Europe: The Archaeology of Water Transport to AD 1500*. London and New York: Longman.
- 82 M^cGrail, S. (1995). *Celtic Seafaring and Transport in The Celtic Work*, Green, M.J. (ed). Routledge.
- 83 M^cGrail, S. and Millett, M. (1987). *The Archaeology of the HasholmeLogboat*. *The Archaeology Journal* Volume 144.
- 84 M^cKelie, S., (2003): *Marine Archaeology and Heritage potential*, Personal Communication.
- 85 Mercer, J.P, Howe, B., Dunshaw, B., Dziechiuch, M., Munk, W., Birdsall, T., Metzger, K., (1996) Acoustic Thermometry of the ocean climate, a description of the acoustic network., *Journal of the Acoustical Society of America*, 100, 2580 (Abs.).
- 86 Momber, G. (2000). Drowned and Deserted: a submerged prehistoric landscape in the Solent, England. *International Journal for Nautical Archaeology*, Volume 29.
- 87 Munk W., Spindel, R., Baggeroer, A., Birdsall, T., (1994) The Heard Island feasibility test., *Journal of the Acoustical Society of America*, 96, 2330-2342.
- 88 Musson R.M.W. (1997). UK Continental Shelf seismic hazard. Health and Safety Division Offshore Technology Report OTH 93416.
- 89 Nedwell, J., Martin, A. & Mansfield, N. (1993). Underwater tool noise: implications for hearing loss., *Subtech '93*. (Vol. 31 in 'Advances in Underwater Technology, Ocean Science and Offshore Engineering'), 267-275. Kluwer Academic Publishers, Dordrecht, The Netherlands.
- 90 Nedwell, Parvin (tool noise)- also as K. Needham, J. R. Nedwell, (1999) Measurement of impulsive noise from underwater bolt guns., Subacoustech report reference: 381R0104.
- 91 NESS/NEXT Metocean Hindcast Model for the North Sea. (Joint Industry Project)
- 92 Newell R.C, Seiderer L.J. & Hitchcock D.R, (1998). The impact of dredging works in coastal waters: a review of the sensitivity to disturbance and subsequent recovery of biological resources on the seabed. *Oceanography and Marine Biology: an Annual Review*, 36: 127-178.
- 93 Nybakken. J. W., (1997). *Marine Biology – an ecological approach*. Fourth Edition. Addison-Wesley Educational Publishers Inc.
- 94 O'Brien, C. 1988. Newcastle Upon Tyne and its North Sea Trade in Waterfront Archaeology CBA Resarch Report No.74.
- 95 O'Connor B.A (1987). Long and short changes in estuary capacity. *Journ. Geol. Soc. Lond.* 144, 187 – 195.
- 96 Phillips 66 (2000).Maureen Alpha Complex (Block 16/29a) Decommissioning Programme, Internal Document.
- 97 Porteous, A., et al. (2000): *Dictionary of Environmental Science and Technology* (Third Edition), John Wiley & Sons Ltd.
- 98 Potter, J. and Delory, E. (1998) Noise Sources in the Sea & the Impact for Those Who Live There. *Acoustics & Vibration Asia 1998 Conference Proceedings* pp. 56-71.
- 99 Ranger Oil (UK) LTD. (1998). Kyle Field Development. Environmental statement for Ranger Oil (UK) LTD.
- 100 Reid, B.J., Evans, P.G.H., and Northridge, S.P., (2003). Atlas of cetacean distribution in north-west European waters. JNCC.
- 101 Richardson, W. et al. (1995), *Marine Mammals and Noise*, Academic Press, 525 B Street, San Diego, California 92101-4495 USA. ISBN 0-12-588440-0.
- 102 Richardson, W., Wursig, B., (1999) Influences of man-made noise and other human actions on cetacean behaviour., *Mar. Freshwat. Behav. Physiol.* 29(1-4), 183-209.
- 103 Side J., (1997) An Estimation of the Energy Consumption and Gaseous Emissions associated with the Heather Platform Decommissioning Operations SPE – 37858.
- 104 Scourse, J.D. et al. (1998). A middle Pleistocene Shallow marine Interglacial Sequence, Inner Silver Pit, Southern North Sea: Pollen and Dinoflagellate Cyst Stratigraphy and Sea-level History. *Quaternary Science Reviews*, Volume 17.
- 105 Sheldrick, C. et al. (1997). Palaeolithic Barbed Point from Gransmoor, East Yorkshire, England. *Proceedings of the Prehistory Soc.* 63, 1997, pp.359- 370.
- 106 Shennan I. et al. (2000). Modelling western North Sea palaeogeographies and tidal changes during the Holocene. *Spec. Publ. Geol. Soc. Lond.* 166. 299-319.
- 107 Skov, H., Dunrick, J., Leopold, M.F., Tasker, M.L. (1995) Important Bird Areas for seabirds in the North Sea including the Channel and Kattegat. *BirdLife International*.
- 108 Smith I.P, Jensen A.C, Collins K.J and Matthey E.L (2001). Movement of wild European lobsters *Homarus gammarus* in natural habitat. *Mar. Ecol. Prog. Ser.* Vol. 222. p. 177-186
- 109 Stone, C.J., Webb, A., Barton, C., Ratcliffe, N., Reed, T.C., Tasker, M.L., Camphuysen, C.J., & Pienkowski, M.W. (1995). *Seabird atlas of North Sea: an atlas of seabird distribution in north-west European waters*, JNCC.

- 110 Terraine, J. (1989). *Business in Great Waters: The U-Boat Wars, 1916-1945*. Wordsworth.
- 111 UKDMAP (1998). *United Kingdom Digital Marine Atlas Project*. Third edition.
- 112 United Kingdom Offshore Operators Association. (1999). *Drill Cuttings Initiative, Research and Development Programme. Activity 2.1. Faunal colonisation of drill cuttings pile based on literature review*.
- 113 Valentin H (1971). Land loss at Holderness. Pp 116-137 in *Applied Coastal Geomorphology*. Ed: Steers, J.A. Macmillan. London.
- 114 Van De Noort, R, et al. (1993). *An Archaeological Assessment of the Humber Wetlands*. Wetland Heritage, Humber Wetlands Project.
- 115 Van De Noort, R, et al. (1999). The 'Kilnsea-Boat' and some implications from the discovery of England's oldest plank boat remains. *Antiquity* 73.
- 116 Vella, G.; Rushforth, I; Mason, E.; Hough, A.; England, R.; Styles, P.; Holt, T.J.; Thorne, P. (2001) *Assessment of the effects of noise and vibration from offshore wind farms on marine wildlife*. Report to The Department of Trade and Industry (in preparation).
- 117 Walker, L.J., Johnston, J., Napier, H., (1999): *European Community Guidelines for the Assessment of Indirect and Cumulative Impacts as well as Impact Interactions*, NE80328/D1/3, EC DG XI Environment, Nuclear Safety & Civil Protection Hyder.
- 118 Wessex Archaeology, (2004): *Ormen Lange Transportation Project: Proposed Pipeline Route and Landfall Site: Archaeology Assessment: Technical Report Ref 55560.01*.
- 119 Wenban-Smith, F. 2001. *Marine Aggregate Dredging and the Historic Environment: Palaeolithic and Mesolithic Archaeology on the Seabed*. Wessex Archaeology Ref:49047.
- 120 Westerberg, H. (1999) *Impact Studies of Sea-Based Windpower in Sweden*. "Technische Eingriffe in marine Lebensraume".
- 121 Whitlow, W., Au, W., Nachtigall, P., Pawloski, J., (1999) *Acoustic effects of the ATOC signal (75Hz, 195 dB) on dolphins and whales.*, *Journal of the Acoustical Society of America*, 101(5) Pt1.
- 122 Whittle, A. (1999). *The Neolithic Period, c.4000-2500/2200BC: Changing the World*, In Hunter, J. & Ralston, I. (eds.) *The Archaeology of Britain*. London: Routledge.
- 123 Wright, E. (1990). *The Ferriby Boats: Seacraft of the Bronze Age*. London: Routledge.
- 124 Wright, P.J., Verspoor, E., Anderson, C., Donald, L., Kennedy, F., Mitchell, A., Munk, P., Pedersen, S.A., Jensen, H., Gislason, H., Lewy, P. (2002). *Project No 94/071: Population structure in the lesser sandeel (Ammodytes marinus) and its implications for fishery predator interactions*.
- 125 Wursig, B., and Evans, P., (1998) *Cetaceans and humans; influences of noise*, Second European Seminar on Marine Mammals, Valencia, Spain.
- 126 Wymer, J. (1999) *The English Rivers Palaeolithic Project Report number 2 1995-1996. The Great Ouse Basin and the Yorkshire and Lincolnshire Wolds*. Wessex Archaeology.
- 127 Wymer, J. (1999) *The Lower Palaeolithic Occupation of Britain* Wessex Archaeology and English Heritage.
- 128 Young, R. (2003). *The Comprehensive Guide to the Shipwrecks of the East Coast. Volume One (1766 – 1917)*.

WEBSITES

- Accessed (2003), from website: <http://www.amphipoda.com/tenuico.html>
- British Marine Aggregate Producers Association (BMAPA) (2003), Various Documents taken from <http://www.bmapa.org>.
- Earth Observatory. Accessed 2003 from website: http://earthobservatory.nasa.gov/Newsroom/NewImages/images.php3?img_id=15314
- Efep. Accessed 2003, from website: <http://www.efep.org/wp2/three.pdf> *European Fisheries Ecosystem Plan*.
- FRS, (2003). Fisheries Research Services web page (Accessed 2003): www.frs-scotland.gov.uk
- Habitats. Accessed 2003, from website: www.habitas.org.uk/marinelife/echinode/ophaff.htm.
- Interwad search. Accessed (2003) from website: <http://www.interwad.nl/default1/defaulteng.htm>
- Itsligo Accessed (2003) from website: <http://www.itsligo.ie/biomar/crustace/CORCAS.HTM>
- Joint Nature Conservation Committee (2001). UK Biodiversity. Accessed 2003, from website: <http://www.ukbap.org.uk/default.htm>
- Joint Nature Conservation Committee. Accessed 2003, from website: <http://www.marlin.ac.uk/index2.htm?species/Spibom.htm>
- Kennet Lundin and Christoffer Schander. Accessed (2003), from website: <http://www.blackwell-synergy.com/links/doi/10.1046/j.1463-6395.1999.00014.x/abs/>
- Marine Biological Association. Accessed, (2003) from website: <http://www.marlin.ac.uk/index2.htm?species/Spibom.htm>.
- Mollusks. Accessed, (2003) from website: <http://members.lycos.co.uk/Mollusks/Schnecken/meer/wellhorn.html>
- School of Biological Sciences (Manchester University). Accessed 2003 from website: <http://www.teaching-biomed.man.ac.uk/bs1999/bs146/biodiversity/mollusca.htm>.
- Triscali. accessed 2003 <http://www.triscali.co.uk/reference/encyclopaedia/hutchinson/m0007914.html>. (Accessed 2003). *Triscali reference. Echinoderm*.
- UK Marine SACs Project. Accessed 2003 from website: <http://www.ukmarinesac.org.uk/communities/habitats-review/hr17.htm>
- Underwater Noise Organisation Various documents accessed, (2003) Web Site: <http://www.underwaternoise.org.uk/>
- Web electronic publication. www.fishbase.org version 16 September 2003

Appendix A – Emissions and Discharges

Emissions and Discharges

The construction activities will have some associated emissions and discharges that are covered in this Appendix.

Construction and Commissioning

Emissions and discharges are potentially one of the most significant issues that arise from pipeline construction and commissioning. Within the *marine pipeline* ES emissions are restricted to the following.

Within the marine section of the pipeline waste will be generated from welding operations and from making field joints. All waste will be collected and shipped to shore for authorised disposal.

No process emissions will take place in the UK marine sector. All testing will take place either at the Sleipner platform in the Norwegian sector or at the Easington onshore terminal under existing, or newly negotiated, permits, and are considered in the relevant ES. In the marine environment emissions will be limited to fuel oil used by the lay barges and support vessels necessary for propulsion and power generation resulting in the following estimated emissions.

Table A.1 Atmospheric Emissions from Construction

Operation	Fuel use (t/day)	Days	Energy Rating (GJ/t)	Total Fuel Use (t)	Energy Use (GJ)	CO ₂	NO _x	SO ₂
						(t)	(t)	(t)
Pipe lay Vessels	10	200	45.4	2000	90,800	6198.0	90.0	90.0
Support Vessels	15	200	45.4	3000	136,200	9296.9	135.0	135.0
Trenching Vessels								
Mob/Demob	5	2	45.4	10	454	31.0	0.4	0.4
Operations	20	50	45.4	1000	45,400	3099.0	45.0	45.0
Rock Dumping Vessel								
Mob/Demob	12	2	45.4	24	1,090	74.4	1.1	1.1
Operations	10	50	45.4	500	22,700	1549.5	22.5	22.5
TOTAL- Subsea Installation				6,534	296,644	20,249*	294*	294*
Emission Factors (Side <i>et al</i>, 1997) (tonnes produced/tonne fuel burned)						CO₂	NO_x	SO₂
Marine Diesel						3.1	0.045	0.045
Engine Diesel						3.1	0.0058	0.005
Aviation Fuel						2.84	0.02	0.008

*Estimates based on the planned construction phase

Source: [ref 103]

Waters from washing and laundry facilities and sewage will be discharged under permit as is common with any offshore activity and will take place from the various vessels used in construction. These discharges will be *ad hoc* and occur at any point along the pipeline outside of 12 nm. Table A.2 gives an estimate of these discharges. Sewage discharges will undergo some treatment prior to release. This will vary from fine screen maceration to full enzymic degradation. The exact form of treatment available on each vessel is not known.

Table A.2 Aqueous Discharges during Pipe-laying Operations

Pipelaying operations	Persons on Board*	Days	Grey Water** (litres)	Sewage*** (litres)
Deep Water Operations				
Pre-lay Sweeping	15	30	45000	22500
Stolt Offshore LB200	403	186	7495800	3747900
Support Vessels	50	186	930000	465000
Post-lay (Spot) Trenching	10	20	20000	10000
Shallow Water Operations				
Pre-lay Sweeping	15	30	45000	22500
Tog Mor	112	60	672000	336000
Support Vessels	50	60	300000	150000
Post-lay (Spot) Trenching	10	21	21000	10500
TOTALS			9528800	4764400

* Estimate based on total number of beds

** Grey Water- Estimated 100 litres/person/day

***Sewage – Estimated at 50 litres/person/day

Source: [ref 39]

The following activities, which relate to pipelaying, are likely to generate noise:

- cofferdam construction including the driving of sheet piles;
- areas where intervention works will occur (see Table 3.1); and
- rock dumping at crossing points and other defined locations.

Operation

Within the scope of this Marine Pipeline ES, no emissions are expected once the pipeline is fully operational.