

# Dudgeon and Sheringham Shoal Offshore Wind Farm Extensions

## Scoping Report

October 2019



<b>Title:</b> <b>Dudgeon and Sheringham Shoal Offshore Wind Farm Extensions – Scoping Report</b>
<b>Document no.:</b> <b>PB8164-RHD-ZZ-XX-RP-Z-0003</b>

<b>Date:</b>	<b>Classification</b>
<b>October 2019</b>	<b>Open</b>

Prepared by (Organisation unit / Name):	Date/Signature:	<i>Pharaoh</i>
<b>Royal HaskoningDHV</b>	7 <sup>th</sup> October 2019	
Responsible (Organisation unit/ Name):	Date/Signature:	<i>Pharaoh</i>
<b>RHDHV / Adam Pharaoh</b>	7 <sup>th</sup> October 2019	
Approved by (Organisation unit/ Name):	Date/Signature:	<i>Magnus Eriksen</i>
<b>Equinor / Magnus Eriksen</b>	7 <sup>th</sup> October 2019	

## Executive Summary

This Scoping Report supports a request for a formal Environmental Impact Assessment (EIA) Scoping Opinion from the Planning Inspectorate for the proposed Dudgeon Extension Project (DEP) and Sheringham Extension Project (SEP). The existing Sheringham Shoal and Dudgeon Offshore Wind Farms are owned by different partners, with Equinor New Energy Limited being the only partner with ownership in both. Equinor will lead on the development work for both extension projects, and will be the named Applicant.

DEP and SEP each have an expected capacity greater than 100MW and will therefore both be defined as Nationally Significant Infrastructure Projects and as such EIA is required as part of a Development Consent Order (DCO) application under the Planning Act 2008.

DEP is to the north and southeast of the existing Dudgeon Offshore Wind Farm and SEP is to the north and east of the existing Sheringham Shoal Offshore Wind Farm, with both sharing borders with the operational assets. Both projects would reduce greenhouse gas emissions, provide energy security, and maximise economic opportunities from investment for the UK.

Offshore export cables will connect offshore substation(s), situated within the wind farm area(s), to shore on the North Norfolk Coast. There are currently two landfall areas being considered, the Weybourne area and the Bacton area.

The projects will also require onshore infrastructure in order to connect the offshore wind farms to the National Grid, which will comprise underground cables from landfall to an onshore substation. The Applicant has accepted an offer from National Grid for connection at Norwich Main that could accommodate both Projects.

The exact locations of the offshore and onshore infrastructure are not yet finalised. Site selection activities are ongoing and responses to the Scoping Request and an ongoing program of consultation will help to inform the refinement of the projects as the EIA is progressed.

Equinor will seek to develop DEP and SEP as an integrated project with an integrated grid option providing transmission infrastructure which serves both projects. Such an approach will particularly benefit the planning and construction of the electrical infrastructure system, is likely to reduce the overall environmental impact and helps to respond to any concerns regarding the lack of a holistic approach to offshore wind development in general. However, given the different ownership of the projects, a separated grid option (transmission infrastructure which allows each project to transmit electricity entirely separately) will allow the projects to be constructed in a phased approach, if necessary. Therefore the application will seek consent for alternative grid solutions in the same overall corridors to allow for both the integrated and separated grid options. The EIA will consider the appropriate realistic worst-case scenario and present the results accordingly.

The EIA (and accompanying Habitats Regulations Assessment) will be completed by competent experts using best practice and following appropriate guidance. This Scoping Report is the first stage of the assessment process, outlining all of the receptors that will be considered and the planned approaches to characterising the existing environment and assessing potential impacts associated with the projects. Equinor is committed to engaging with the community and stakeholders and will undertake consultation throughout the EIA and application process, as outlined in this document.

## Table of contents

<b>Executive Summary</b> .....	<b>3</b>
<b>Glossary of Acronyms</b> .....	<b>6</b>
<b>Glossary of Terms</b> .....	<b>10</b>
<b>1 PART 1: INTRODUCTION</b> .....	<b>12</b>
1.1 Project Overview .....	12
1.2 Need for the Proposed Projects .....	15
1.3 Policy and Legislative Context .....	17
1.4 Site Selection and Assessment of Alternatives .....	23
1.5 Proposed Development Description .....	28
1.6 EIA Methodology .....	47
<b>2 PART 2: OFFSHORE</b> .....	<b>57</b>
2.1 Marine Geology, Oceanography and Physical Processes .....	57
2.2 Marine Water and Sediment Quality .....	62
2.3 Benthic and Intertidal Ecology .....	67
2.4 Fish and Shellfish Ecology .....	75
2.5 Marine Mammal Ecology .....	83
2.6 Offshore Ornithology .....	94
2.7 Commercial Fisheries .....	99
2.8 Shipping and Navigation .....	103
2.9 Offshore Archaeology and Cultural Heritage .....	110
2.10 Aviation and MoD .....	117
2.11 Offshore Designated Sites .....	124
2.12 Offshore Air Quality .....	127
2.13 Other Marine Users .....	128
<b>3 PART 3: ONSHORE</b> .....	<b>135</b>
3.1 Onshore Ground Conditions and Contamination .....	135
3.2 Water Resources and Flood Risk .....	140
3.3 Land Use and Agriculture .....	146
3.4 Ecology and Ornithology (including Sites of Nature Conservation Interest) .....	151
3.5 Onshore Archaeology and Cultural Heritage .....	164
3.6 Air Quality .....	171
3.7 Noise and Vibration .....	174
3.8 Traffic and Transport .....	180
<b>4 PART 4: WIDER SCHEME ASPECTS</b> .....	<b>186</b>
4.1 Seascape, Landscape and Visual .....	186
4.2 Socio-Economics .....	191
4.3 Health .....	196
4.4 Tourism and Recreation .....	199
<b>5 PART 5: CONSULTATION</b> .....	<b>207</b>
<b>6 PART 6: SUMMARY AND CONCLUSIONS</b> .....	<b>208</b>



<b>7</b>	<b>REFERENCES .....</b>	<b>221</b>
	<b>APPENDIX 1 NPS ASSESSMENT REQUIREMENTS .....</b>	<b>237</b>
	<b>APPENDIX 2 FIGURES.....</b>	<b>255</b>

## Glossary of Acronyms

AA	Appropriate Assessment
AAWT	Annual Average Weekday Traffic
ADR	Air Defence Radar
ADS	Archaeology Data Service
AfL	Agreement for Lease
AIS	Automatic Identification System
ALC	Agricultural Land Classification
AoI	Area of Interest
AONB	Area of Outstanding Natural Beauty
AQMA	Air Quality Management Area
ATC	Air Traffic Control
B&B	Bed and Breakfast
BAT	Best Available Technology
BDC	Broadland District Council
BEIS	Department for Business Energy and Industrial Strategy
BGS	British Geological Survey
BMV	Best and Most Versatile Land
BoCC	Birds of Conservation Concern
BPM	Best Practicable Means
BS	British Standard
BSI	British Standards Institution
CAA	Civil Aviation Authority
CAP	Civil Aviation Publication
Cefas	Centre for Environment, Fisheries and Aquaculture Science
CIA	Cumulative Impact Assessment
CIEEM	Chartered Institute of Ecology and Environmental Management
CIfA	Chartered Institute for Archaeologists
CION	Connection and Infrastructure Operations Note
COP	Conference of the Parties
CRM	Collision Risk Modelling
CWS	County Wildlife Site
DCO	Development Consent Order
DECC	Department for Energy and Climate Change
DEFRA	Department for the Environment and Rural Affairs
DEP	Dudgeon Extension Project
DMRB	Design Manual for Roads and Bridges
DOW	Dudgeon Offshore Wind Farm
EC	European Commission
EclA	Ecological Impact Assessment
EEZ	Exclusive Economic Zone
EIA	Environmental Impact Assessment
EIFCA	Eastern Inshore Fisheries and Conservation Authority
EMF	Electromagnetic Field
EPA	Environmental Protection Act
EPP	Evidence Plan Process

EPS	European Protected Species
EPUK	Environmental Protection United Kingdom
EQS	Environmental Quality Standards
ERCoP	Emergency Co-Operation Plan
ES	Environmental Statement
ETG	Expert Topic Group
EU	European Union
EUNIS	European Nature Information System
FIR	Flight Information Regions
FLO	Fisheries Liaison Officer
FLOWW	Fishing Liaison with Offshore Wind and Wet Renewables Group
FRA	Flood Risk Assessment
GBS	Gravity Based Structure
GEART	Guidelines for the Environmental Assessment of Road Traffic
GIS	Geographical Information System
GPS	Global Positioning System
HAT	Height Above Tip
HDD	Horizontal Directional Drilling
HES	Historic Environment Services
HGV	Heavy Goods Vehicle
HMR	Helicopter Main Route
HRA	Habitats Regulations Assessment
HSC	Historic Seascape Characterisation / Character
HSE	Health and Safety Executive
HVAC	High-Voltage Alternating Current
HVDC	High-Voltage Direct Current
IAMMWG	Inter-Agency Marine Mammal Working Group
IAQM	Institute of Air Quality Management
IBTS	International Bottom Trawl Survey
ICES	International Council for Exploration of the Sea
IDB	Internal Drainage Board
IMARES	Institute of Marine Research
IPC	Infrastructure Planning Commission
IROPI	Imperative Reasons of Overriding Public Interest
ISO	International Standards Organisation
IUCN	International Union for the Conservation of Nature
IVLO	Institute for Agriculture, Fisheries and Food
JCP	Joint Cetacean Protocol
JNCC	Joint Nature Conservation Committee
km	Kilometre
LIDAR	Light Imaging, Detection And Ranging
LLCA	Local Landscape Character Area
LLFA	Lead Local Flood Authority
LLSOA	Lower Layer Super Output Area
LPA	Local Planning Authority
LVIA	Landscape and Visual Assessment
LWS	Local Wildlife Site

MarESA	Marine Evidence Based Sensitivity Assessment
MarLIN	Marine Life Information Network
MARPOL	International Convention for the Prevention of Pollution from Ships
MCA	Maritime and Coastguard Authority
MCAA	Marine and Coastal Access Act
MCZ	Marine Conservation Zone
MHWS	Mean High-Water Springs
MMMP	Marine Mammal Mitigation Protocol
MMO	Marine Management Organisation
MoD	Ministry of Defence
MP/TP	Monopile/Transition Piece Concept
MPA	Marine Protected Area
MPS	Marine Policy Statement
MSFD	Marine Strategy Framework Directive
MU	Management Unit
MW	Megawatts
NATS	National Air Traffic Services
NBIS	Norfolk Biodiversity Information Service
NERL	National Air Traffic Services En Route Ltd
NHER	Norfolk Historic Environment Record
NHES	Norfolk Historic Environment Service
NHLE	National Heritage List for England
NMFS	National Marine Fisheries Services
NNDC	North Norfolk District Council
NNDR	Norwich Northern Distributor Road
NNR	National Nature Reserve
NO <sub>2</sub>	Nitrogen dioxide
NOAA	National Oceanic and Atmospheric Administration
NorCC	Norwich City Council
NP	National Park
NPPF	National Planning Policy Framework
NPS	National Policy Statement
NRHE	National Record of the Historic Environment
NSIP	Nationally Significant Infrastructure Project
NSR	Noise Sensitive Receptor
NUC	Not Under Command
O&G	Oil & Gas
OESEA	Offshore Energy Strategic Environmental Assessment
OFGEM	Office of Gas and Electricity Markets
OFTO	Offshore Transmission Operator
ONS	Office for National Statistics
OS	Ordnance Survey
OSPAR	Oslo/Paris Convention
OWF	Offshore Wind Farm
PEIR	Preliminary Environmental Information Report
PHE	Public Health England
PM <sub>10</sub>	Particulate matter with an aerodynamic diameter of 10µm or less

PM <sub>2.5</sub>	Particulate matter with an aerodynamic diameter of 2.5µm or less
PPG	Planning Practice Guidance
PPV	Peak Particle Velocity
PRA	Preliminary Risk Assessment
PRoW	Public Rights of Way
pSAC	proposed Special Area of Conservation
pSPA	Potential Special Protection Area
PSR	Primary Surveillance Radar
PTS	Permanent Threshold Shift
RAF	Royal Air Force
RAMSAR	Ramsar Convention on Wetlands
RBMP	River Basin Management Plan
ROV	Remote Operated Vehicle
SAC	Special Area of Conservation
SAR	Search and Rescue
SCANS	Small Cetaceans in the European Atlantic and North Sea
SCOS	Special Committee on Seals
SEA	Strategic Environmental Assessment
SEP	Sheringham Extension Project
SIP	Site Integrity Plan
SLM	Sound Level Meter
SLVIA	Seascape, Landscape and Visual Impact Assessment
SMRU	Sea Mammal Research Unit
SNC	South Norfolk Council
SNCB	Statutory Nature Conservation Body
SNS	Southern North Sea
SoS	Secretary of State
SPA	Special Protection Area
SPZ	Source Protection Zone
SSSI	Site of Special Scientific Interest
TEU	Treaty of the European Union
TTS	Temporary Threshold Shift
TWT	The Wildlife Trusts
UK	United Kingdom
UN	United Nations
UNECE	United Economic Commission for Europe
UXO	Unexploded Ordnance
VDV	Vibration Dose Value
VMS	Vessel Monitoring System
WDC	Whale and Dolphin Conservation
WFD	Water Framework Directive
WHO	World Health Organisation
WTG	Wind Turbine Generator
WWII	World War Two
WWT	Wildfowl and Wetlands Trust
ZTV	Zone of Theoretical Visibility

## Glossary of Terms

Array cables	Cables which link the wind turbine generators to the offshore substation platforms.
Dudgeon Offshore Wind Farm Extension site	The Dudgeon Offshore Wind Farm Extension offshore wind farm boundary.
The Dudgeon Offshore Wind Farm Extension Project (DEP)	The Dudgeon Offshore Wind Farm Extension site as well as all onshore and offshore infrastructure.
European site	Sites designated for nature conservation under the Habitats Directive and Birds Directive. This includes candidate Special Areas of Conservation, Sites of Community Importance, Special Areas of Conservation and Special Protection Areas, and is defined in regulation 8 of the Conservation of Habitats and Species Regulations 2017.
Evidence Plan Process (EPP)	A voluntary consultation process with specialist stakeholders to agree the approach, and information to support, the EIA and HRA for certain topics.
Horizontal directional drilling (HDD) zones	The areas within the onshore cable route which would house HDD entry or exit points.
Interlink cables	Buried offshore cables which link offshore substation platforms.
Integrated Grid Option	Transmission infrastructure which serves both extension projects
Jointing bays	Underground structures constructed at regular intervals along the onshore cable route to join sections of cable and facilitate installation of the cables into the buried ducts.
Landfall	The point at the coastline at which the offshore export cables are brought onshore, connecting to the onshore cables at the transition joint bay above mean high water
Landfall search areas	The areas being considered within which the landfall would be located. A single landfall location will be identified prior to submission of the Preliminary Environmental Information Report (PEIR).
Offshore export cables	The cables which would bring electricity from the offshore substation platform(s) to the landfall.
Offshore scoping area	An area that encompasses all planned offshore infrastructure, including landfall options at both Weybourne and Bacton, and allows sufficient room for receptor identification and environmental surveys. This will be refined following further site selection and consultation.
Offshore substation platform	A fixed structure located within the wind farm area, containing electrical equipment to aggregate the power from the wind turbine generators and convert it into a more suitable form for export to shore.

Onshore cable route search area	The areas being considered within which the onshore cable route would be located. A single landfall location and onshore cable route will be identified prior to PEIR.
Onshore scoping area	An area that encompasses all planned onshore infrastructure and allows sufficient room for receptor identification and environmental surveys. This will be refined following further site selection and consultation.
Separated Grid Option	Transmission infrastructure which allows each project to transmit electricity entirely separately
Substation search area	An area within which the onshore substation is likely to be located. Further iterations of this area will be developed in 2020 following review of feedback from public drop-in exhibitions and other input from other stakeholders. An onshore project substation location will be defined prior to PEIR.
Study area	Area where potential impacts from the project could occur, as defined for each individual EIA topic.
Sheringham Shoal Offshore Wind Farm Extension site	Sheringham Shoal Offshore Wind Farm Extension offshore wind farm boundary.
The Sheringham Offshore Wind Farm Extension Project (SEP)	The Sheringham Offshore Wind Farm Extension site as well as all onshore and offshore infrastructure.
The Applicant	Equinor ASA

## 1 PART 1: INTRODUCTION

### 1.1 Project Overview

1. This document supports a request for a formal Environmental Impact Assessment (EIA) Scoping Opinion from the Planning Inspectorate for the proposed Dudgeon Extension Project and Sheringham Extension Project. The existing Dudgeon and Sheringham Shoal Offshore Wind Farms are owned by different partners, with Equinor New Energy Limited (hereafter called Equinor) being the only partner with ownership in both projects.
2. It has been agreed by the partners that Equinor will lead on the development work for both projects, and will be the named Applicant. This Scoping Report has been prepared on behalf of Equinor<sup>1</sup> and in accordance with Regulation 10 of the Infrastructure Planning (Environmental Impact Assessment) Regulations 2017.
3. The Scoping Report considers two projects:
  - Dudgeon Extension Project (hereafter DEP); and
  - Sheringham Extension Project (hereafter SEP).
4. DEP is located to the north and southeast of the existing Dudgeon Offshore Wind Farm and SEP is located to the north and east of the existing Sheringham Shoal Offshore Wind Farm (**Appendix 2, Figure 1.1.1**). Both DEP and SEP share borders with the operational assets.
5. DEP and SEP each have an expected capacity greater than 100MW and will therefore be defined as Nationally Significant Infrastructure Projects (NSIPs) under Section 15(3) of the Planning Act 2008.
6. Offshore export cables will connect the offshore substation(s), situated within the wind farm area/s, to shore on the North Norfolk Coast (**Appendix 2, Figure 1.1.1**). There are currently two landfall areas being considered, the Weybourne area and the Bacton area.
7. Onshore export cables will connect the projects to a new purpose-built substation in the vicinity of the existing Norwich Main substation south of Norwich. DEP and SEP will be connected to the National Grid at Norwich Main substation. **Figure 1.1.1** in **Appendix 2** shows search areas for the proposed onshore infrastructure.

#### 1.1.1 Project Background

8. In 2018 The Crown Estate invited developers to bid for extensions to operating offshore wind farms. Equinor applied, on behalf of the partners in the operational wind farm projects, for an Agreement for Lease (AfL) for the extension of the Dudgeon and Sheringham Shoal Offshore Wind Farms. An acceptance letter from The Crown Estate was received in September 2019 and AfLs are expected to be signed in October 2019.
9. DEP and SEP have been offered a grid connection from National Grid accommodating both projects at Norwich Main substation.

<sup>1</sup> It should be noted that the Development Consent Order will have two named undertakers, one for each Nationally Significant Infrastructure Project – [Sheringham SPV company] and [Dudgeon SPV company]. It is these two companies which are the parties to the two Agreements for Lease with The Crown Estate.



### 1.1.2 Consenting strategy

10. A number of potential consenting strategies have been considered for DEP and SEP, and the Applicant has determined that the most appropriate approach is a single application for development consent addressing both wind farm extensions and their associated transmission infrastructure.
11. Separate Deemed Marine Licences will be requested as schedules to the Development Consent Order (DCO) to cover the arrays and associated transmission infrastructure.
12. Adopting a strategy to develop DEP and SEP through a single planning process and DCO application is believed to have benefits as it allows for consistency throughout, including the approach to assessments, consultation and examination, and will provide increased transparency for a potential compulsory acquisition process.
13. Whilst the Projects will be the subject of a single DCO application (with a combined EIA process and associated submissions), each project will be assessed individually so that mitigation is project specific (where appropriate). As such, the assessments will cover the possibility that one or the other (but not both) of the projects are developed, as well as both projects being developed, either concurrently or sequentially.
14. Equinor will seek to develop DEP and SEP as an integrated project with an integrated grid option. Such an approach will particularly benefit the planning and construction of the electrical infrastructure system. An integrated approach to electrical infrastructure would include:
  - a single offshore substation;
  - parallel export cable routes offshore and through landfall;
  - onshore cables in the same trench;
  - a single onshore substation; and
  - a single connection from the onshore substation to the Norwich Main substation.
15. An integrated grid option is likely to reduce the overall environmental impact as the total footprint is likely to be smaller than that for a separate grid option (details below). Integrating the electrical infrastructure of DEP and SEP also helps to respond to any concerns regarding the lack of a holistic approach to offshore wind development in general.
16. However, given the different ownership of the two projects, it is feasible that DEP and SEP may be constructed in a phased approach. This would require a separate grid option (i.e. standalone connections) which may include:
  - two offshore substations, one in each extension area;
  - an interlink cable between the two offshore substations;
  - parallel export cable routes offshore and through landfall;
  - onshore cables in parallel trenches;
  - an onshore substation; and
  - two connections from the onshore substation to the Norwich Main substation.
17. The EIA will consider the appropriate realistic worst-case scenario and present the results accordingly.

18. The application will seek consent for alternative grid solutions in the same overall corridors to allow for both the integrated and separate grid options. The latter approach has already been done with multiple NSIPs in a single DCO.
19. Equinor recognises the potential complexities associated with the consenting approach proposed and will work with key stakeholders through the pre-application process to understand how these can be best resolved.

### 1.1.3 The Scoping Report

#### 1.1.3.1 Scoping Report Structure

20. The Scoping Report is set out as follows:

- **Part 1 – Introduction (this section)**
  - Project Overview – this section introduces the Scoping Report and the proposed Projects;
  - Need for the Proposed Projects – a discussion of the key drivers for offshore wind and the proposed development;
  - Policy and Legislative Context – a high-level overview of where DEP and SEP sit within the policy and legislative context and how this proposed development aims to fulfil policy needs and meet all environmental requirements;
  - Site Selection and Assessment of Alternatives – an outline of the site selection process to date and the further assessment that will be undertaken in order to define the final proposed development description for the EIA;
  - Proposed Development Description – a high-level description of the key elements of the proposed development both offshore and onshore, and a description of the associated construction, operation and decommissioning phases; and
  - EIA Methodology – a description of how the EIA will be undertaken, the philosophy and approach behind the assessment and key areas of consideration.
- **Part 2 – Offshore**
  - Offshore Environmental Baseline and Potential Impacts – a discussion of the baseline, potential impacts, approach to the EIA and data sourcing for each topic, covering the physical, biological and human environment; and
  - Summary of offshore designated sites – an overview of the relevant sites and species designated under the national and international legislation described in Part 1 and referred to under each topic, where relevant.

- **Part 3 – Onshore**
  - Onshore Environmental Baseline and Potential Impacts – a discussion of the baseline, potential impacts, approach to the EIA and data sourcing for each topic, covering the physical, biological and human environment; and
  - Summary of onshore designated sites – an overview of the relevant sites and species designated under the national and international legislation described in Part 1 and referred to under each topic, where relevant (included under the onshore ecology section).
- **Part 4 – Wider Scheme Aspects**
  - This section considers aspects that are relevant for both the onshore and offshore assessments (landscape, seascape and visual, socio-economic, health, and tourism and recreation).
- **Part 5 – Consultation**
  - A summary of the proposals for ongoing consultation and stakeholder engagement through the EIA process.
- **Part 6 – Summary and Conclusions**

#### 1.1.4 Development Program

21. At the time of writing, the development program is being devised but with a target DCO submission date of Q3 2021. The following key milestones are planned:
- Submission of Scoping Report to the Planning Inspectorate – Q4 2019;
  - Pre-application consultation with local communities and those who would be directly affected by the proposal – ongoing. A Statement of Community Consultation setting out the process of community consultation process will also be developed in Q1 2020;
  - Surveys, data gathering and environmental assessment supported by an Evidence Plan Process (EPP) and wider stakeholder engagement – 2019 to 2021;
  - Habitats Regulations Assessment Screening Report and Marine Conservation Zone (MCZ) Screening – 2020;
  - Preliminary Environmental Information Report (PEIR) submission and associated formal consultation based on a draft Environmental Statement (ES) (further details in [Section 1.6](#)) – early 2021;
  - Draft MCZ assessment and draft Habitats Regulations Assessment (HRA) report with the PEIR; and
  - DCO application submission (including final MCZ assessment and HRA report) – Q3 2021.

#### 1.2 Need for the Proposed Projects

22. The key drivers underpinning the need for offshore wind power projects are:
- The need to reduce greenhouse gas emissions;
  - The need for energy security;

- The need to maximise economic opportunities from energy infrastructure investment in the UK; and
- The need to produce affordable energy.

### 1.2.1 The need to reduce greenhouse gas emissions

23. Latest predictions, based on a 'business-as-usual' greenhouse gas concentration scenario, suggest global air temperatures could rise up to 5°C above pre-industrial levels by 2100 (CSSR, 2017).
24. Commitment was made during the 21<sup>st</sup> Conference of the Parties (COP) in Paris in 2015 to pursue efforts to limit the global temperature increase to within 2°C of the pre-industrial era, with aspirations for an improved limit of 1.5°C. This was ratified by the UK foreign secretary in November 2016 and implemented through the fifth UK Carbon Budget which commits the UK to a 57% reduction in carbon emissions by 2032, compared to emission levels in 1990 (HM Government 2016).
25. The Committee on Climate Change has also recommended that the UK government should support 1-2GW of new offshore wind per year in the 2020s (Committee on Climate Change 2015). In the longer term, through the Climate Change Act 2008, the UK made the commitment to an 80% reduction (compared to 1990 levels) in greenhouse gas emissions by 2050. More recently, in June 2019, the Government put forward the draft Climate Change Act 2008 (2050 Target Amendment) Order 2019 to amend the Climate Change Act 2008 by introducing a target for at least a 100% reduction of greenhouse gas emissions (compared to 1990 levels) in the UK by 2050, also known as a net zero target. The Order came into force on 27 June 2019.

### 1.2.2 The need for energy security

26. Overall net energy import reduced in 2018, accounting for 36.0% of the total energy used in the UK. Total energy production increased 2.9% from 2017, driven by growth from primary oil, wind, solar and bioenergy and waste (DECC, 2019). However, with declining fossil fuel reserves and aging nuclear power infrastructure there remains a need for new energy sources.
27. Many of the UK's older fossil fuel and nuclear plants have either reached the end of their operational life span, are no longer economical to run, and/or do not meet legal air quality limits. The UK Energy Security Strategy estimated that around a fifth of the energy capacity available in 2011 will close by 2020 (DECC, 2012).

### 1.2.3 The need to maximise economic opportunities

28. The UK is able to continue growth in the offshore wind sector by maximising domestic energy resources and utilising the vast offshore wind resource to which the UK has access. The UK also has a strong supply chain for offshore wind. The Green Paper: Building our Industrial Strategy (HM Government, 2017) focusses on delivering affordable energy and green growth.

29. According to the 2017 Report on Offshore Wind UK Content (RenewableUK, 2017), 48% of the total expenditure associated with UK offshore wind farms was spent in the UK in 2015. The UK content of expenditure during the development stage and operation of offshore wind projects was 73% and 75% respectively in 2015, whereas during manufacturing and construction the UK content was 29% (RenewableUK, 2017).

### 1.2.4 The need to produce affordable energy

30. In order to help meet the targets described in the sections above, renewable energy needs to be affordable. Through offshore wind developer led innovation there has been a significant reduction in the levelized cost of energy in recent years, specifically 32% cost reduction between 2012 and 2016 (ORE Catapult 2017). Developers are continuing to drive these changes through technology development and new work processes. The development of DEP and SEP will contribute to this process. In addition, there are specific cost efficiencies from synergies with the existing wind farms and the proposal for a shared export cable route , which optimises overall design and cost.

## 1.3 Policy and Legislative Context

31. UK legislation is underpinned by a number of international (e.g. EU and United Nations (UN)) agreements, which are outlined in this section. Following the triggering of Article 50 of the Treaty on European Union (TEU) on the 29<sup>th</sup> March 2017, by which the UK has committed to a withdrawal from the EU, the UK will continue to be committed to all EU treaties until finalisation of the withdrawal agreement and/or until 31<sup>st</sup> October 2019. At the time of writing, the exact nature of amendments to UK legislation which had an origin in EU law is uncertain, however any changes to relevant policy and legislation will be considered as the EIA process is taken forward.

32. A full explanation of the relevant policy and legislation for the project will be provided in the ES, along with details of the specific legislation relevant to each topic.

### 1.3.1 Climate Change and Renewable Energy Policy and Legislation

33. National, European and Global level climate change policy key aspects are presented in **Table 1-1**.

*Table 1-1 Summary of relevant climate change policy*

Policy	Key Commitments
<b>United Nations Framework Convention on Climate Change (Kyoto Protocol)</b>	<ul style="list-style-type: none"> <li>• Limit global temperature increase to below 2°C, while pursuing efforts to limit the increase to 1.5°C;</li> <li>• Commitments by all Parties to prepare communicate and maintain a Nationally Determined Contribution (NDC); and</li> <li>• In 2023 and every 5 years thereafter, a global stocktake will assess collective progress toward meeting the purpose of the Agreement.</li> </ul>

Policy	Key Commitments
<b>European Union Renewables Directive/Renewable Energy Directive</b>	<ul style="list-style-type: none"> <li>• A reduction of 20% in greenhouse gases by 2020 (below 1990 levels); and</li> <li>• 20% of the total EU energy (electricity, heat and fuel) consumption to come from renewable sources by 2020.</li> </ul>
<b>The UK Energy Act (2013)</b>	<ul style="list-style-type: none"> <li>• Introduction of the Contracts for Difference (CfDs) support mechanism.</li> </ul>
<b>The Climate Change Act 2008 (2050 Target Amendment) Order 2019</b>	<ul style="list-style-type: none"> <li>• If met, this target would effectively mean that the UK will end its contribution to global emissions by 2050. Before this amendment, the UK had a long-term emissions reduction target of reducing greenhouse gas emissions by 80% by 2050, compared to 1990 levels, set by the Climate Change Act 2008.</li> </ul>

### 1.3.2 Planning Legislation

34. The Planning Act 2008 (as amended by the Marine and Coastal Access Act (MCAA) 2009, the Localism Act 2011, the Growth and Infrastructure Act 2013, and the Infrastructure Act 2015) is the primary legislation that establishes the legal framework for applying for, examining and determining applications for NSIPs taking into account the guidance in National Policy Statements (NPSs).

#### 1.3.2.1 National Policy Statements

35. NPSs are produced by the UK Government and set out national policy against which applications for major infrastructure projects will be assessed and determined by the Planning Inspectorate. NPSs include the Government’s objectives for the development of nationally significant infrastructure. There are twelve NPSs in total, of which six are relevant to energy. The three NPSs of relevance to DEP and SEP are:

- EN-1 Overarching Energy;
- EN-3 Renewable Energy Infrastructure, which identifies the construction of offshore generating stations in excess of 100MW as NSIPs; and
- EN-5 Electricity Networks, which covers the electrical infrastructure in conjunction with EN-1.

36. A summary of the NPS assessment requirements is provided in relation to each topic in **Appendix 1** of this Scoping Report. These are focused on the specific assessment requirements for each topic although the assessments taken forward in the EIA will have regard to all relevant aspects of the NPSs, for example with respect to potential mitigation or monitoring requirements.



### 1.3.2.2 Requirement for EIA and the EIA Process

37. EIA was introduced under the European Union (EU) EIA Directive 85/337/EEC (as amended by Directives 97/11/EC, 2003/35/EC and 2009/31/EC). In 2011, the original EIA Directive and amendments were translated into EIA Directive 2011/92/EU (as amended by Directive 2014/52/EU). The EIA Directive is transposed into English law for NSIPs by the Infrastructure Planning (Environmental Impact Assessment) Regulations 2017 (the EIA Regulations).
38. The EIA process will take account of guidance provided by the Planning Inspectorate. The following Advice Notes are considered to be of particular relevance:
- Advice Note Three: EIA consultation and notification (the Planning Inspectorate, 2017a);
  - Advice Note Seven: Environmental Impact Assessment, Preliminary Environmental Information, Screening and Scoping (the Planning Inspectorate, 2017b);
  - Advice Note Nine: Rochdale Envelope (the Planning Inspectorate, 2017c);
  - Advice Note Ten: Habitats Regulations Assessment (the Planning Inspectorate, 2017d);
  - Advice Note Twelve: Transboundary Impacts (the Planning Inspectorate, 2018a); and
  - Advice Note Seventeen: Cumulative effects assessment relevant to nationally significant infrastructure projects (the Planning Inspectorate, 2018b).

### 1.3.2.3 Transboundary Considerations

39. The United Nations Economic Commission for Europe (UNECE) convention (the 'Espoo Convention') sets out the obligations of States to notify and consult each other on all major projects under consideration that are likely to have a significant adverse environmental effect across international boundaries (transboundary effects). The Planning Inspectorate issued Advice Note Twelve: Development with significant transboundary impacts consultation (Planning Inspectorate, 2015c). This note sets out the procedures for consultation in association with an application for development consent, where such development may have significant transboundary impacts. The Guidance provided in Advice Note Twelve will be followed by DEP and SEP (Planning Inspectorate, 2015c).

### 1.3.3 Environmental Legislation

40. A range of environmental legislation at International, European and National level will apply to DEP and SEP. These will be described in the ES and are summarised in the table below.

Table 1-2 Summary of relevant environmental legislation

Level	Legislation	Key aspects/aims
International	The OSPAR Convention	<ul style="list-style-type: none"> <li>Establish an area of Marine Protected Areas (MPAs)</li> </ul>
	The Convention on Wetlands of International Importance especially as Waterfowl Habitat (Ramsar Convention)	<ul style="list-style-type: none"> <li>Establish Ramsar sites to protect important areas for wildfowl</li> </ul>
	The Convention on Biological Diversity	<ul style="list-style-type: none"> <li>The conservation of biological diversity;</li> <li>The sustainable use of the components of biological diversity; and</li> <li>The fair and equitable sharing of the benefits arising out of the utilisation of genetic resources.</li> </ul>
European	Water Framework Directive (WFD)(2000/60/EEC)	<ul style="list-style-type: none"> <li>Ensure a 'good ecological status' of inland, estuarine and groundwater bodies including coastal surface waters up to an offshore limit of one nautical mile.</li> </ul>
	Marine Strategy Framework Directive (MSFD)(2008/56/EC)	<ul style="list-style-type: none"> <li>Establish a framework within which Member States will take measures to maintain or achieve 'good environmental status' (GES) in the marine environment by 2020.</li> </ul>
	Habitats Directive (92/43/EEC )	<ul style="list-style-type: none"> <li>Implements the Bern and Bonn conventions.</li> <li>Aims to conserve natural habitats of wild fauna and flora and is intended to protect biodiversity by requiring Member States to take measures to maintain or restore natural habitats and wild species, including protection for specific habitats listed in Annex I and species listed in Annex II of the Directive.</li> <li>Establishment under Article 3 of the Directive of a European wide network of protected sites, known as Special Areas of Conservation (SACs).</li> </ul>
	Birds Directive (2009/147/EC)	<ul style="list-style-type: none"> <li>Provides a framework for the conservation and management of wild birds in Europe.</li> </ul>



Level	Legislation	Key aspects/aims
		<ul style="list-style-type: none"> <li>Establishment under Article 4 of the Directive a network of Special Protection Areas (SPAs) for rare or vulnerable species listed in Annex I of the Directive.</li> </ul>
<b>UK Legislation</b>	Marine and Coastal and Access Act 2009	<ul style="list-style-type: none"> <li>Enables the designation of Marine Conservation Zones (MCZs) in England, Wales and UK offshore waters</li> <li>Provisions for the coastal environment including improving access to the coast and undertaking Integrated Coastal Zone Management (ICZM).</li> </ul>
	The Wildlife and Countryside Act 1981	<ul style="list-style-type: none"> <li>Enables the designation of Site of Special Scientific Interest (SSSI) to provide statutory protection to the best examples of flora, fauna, geological and physio-geological features.</li> <li>Enables Statutory Nature Conservation Bodies to declare sites which are considered to be of national importance as National Nature Reserves (NNRs).</li> <li>Makes it an offence to intentionally: kill, injure, or take wild birds and to take, damage or destroy the nest of any wild bird while that nest is in use or being built.</li> <li>Makes it an offence to intentionally kill, injure or take any animal listed in Schedule 5 of the Act and protects occupied and unoccupied places used for shelter or protection.</li> </ul> <p>Makes it an offence to intentionally pick, uproot or destroy any wild plant listed in Schedule 8 and to plant or otherwise cause to grow any non-native, invasive species listed under Schedule 9 of the Act.</p>
	Conservation of Habitats and Species Regulations 2017 (the 'Habitats Regulations')	<ul style="list-style-type: none"> <li>Transposes the requirements of Habitats Directive (see above) into UK law within 12 nautical miles.</li> <li>Makes it an offence to kill, injure, capture or disturb European Protected Species</li> </ul>

Level	Legislation	Key aspects/aims
		(EPS).
	Offshore Marine Conservation (Natural Habitats & c.) Regulations 2017	<ul style="list-style-type: none"> <li>• Transposes the requirements of Habitats Directive (see above) into UK law outside of 12 nautical miles.</li> <li>• Makes it an offence to kill, injure, capture or disturb EPS.</li> </ul>
	Countryside and Rights of Way Act 2000	<ul style="list-style-type: none"> <li>• Gives Natural England the power to designate Areas of Outstanding Natural Beauty (AONBs).</li> </ul>
	The Protection of Badgers Act 1992	<ul style="list-style-type: none"> <li>• Makes it an offence to willfully kill, injure or take, or attempt to kill, injure or take a badger; and to cruelly ill-treat a badger.</li> <li>• Makes it an offence to intentionally or recklessly damage, destroy or obstruct a badger sett, or to disturb a badger whilst in a sett.</li> </ul>
	Natural Environment and Rural Communities Act 2006 (NERC)	<ul style="list-style-type: none"> <li>• Requires the relevant Secretary of State to compile a list of habitats and species of principal importance for the conservation of biodiversity.</li> </ul>

### 1.3.4 Habitats Regulations Assessment

41. Under the Habitats and Species Regulations (2017), the relevant Secretary of State must consider whether a plan or project has the potential to have an adverse effect on the integrity and features of a Natura 2000 site. This process is known as Habitats Regulations Assessment (HRA). Under Regulation 61 of the Habitats and Species Regulations, Appropriate Assessment is required for a plan or project, which either alone or in-combination with other plans or projects, is likely to have a significant effect on a Natura 2000 site and is not directly connected with or necessary for the management of the site.
42. The HRA for DEP and SEP will follow the four-stage process defined by The Planning Inspectorate (2012b), as summarised below.
  - Stage 1: Screening is the process which initially identifies the likely impacts upon a Natura 2000 site of a project or plan, either alone or in-combination with other projects or plans, and considers whether these impacts may be significant. It is important to note that the burden of evidence is to show, on the basis of objective information, that there will be no significant effect; if the effect may be significant, or is not known, that would trigger the need for an Appropriate Assessment;
  - Stage 2: Appropriate Assessment is the detailed consideration of the impact on the integrity of the Natura 2000 site of the project or plan, either alone or in-combination with other projects or plans, with respect to the site's conservation

objectives and its structure and function. This is to determine whether there is objective evidence that adverse effects on the integrity of the site can be excluded. This stage also includes the development of mitigation measures to avoid or reduce any possible impacts;

- Stage 3: Assessment of alternative solutions is the process which examines alternative ways of achieving the objectives of the project or plan that would avoid adverse impacts on the integrity of the Natura 2000 site, should avoidance or mitigation measures be unable to prevent adverse effects; and
- Stage 4: Assessment where no alternative solutions exist and where adverse impacts remain. At Stage 4 an assessment is made as to whether the development is necessary for imperative reasons of overriding public interest (IROPI) and, if so, of the compensatory measures needed to maintain the overall coherence of the Natura 2000 network.

43. It is noted that The Crown Estate as Competent Authority undertook a plan level HRA with respect to the 2017 Offshore Wind Extensions Plan (TCE, 2019), which includes the proposed DEP and SEP. Following Appropriate Assessment, the HRA concluded that there will be no adverse effects on integrity in respect of any European Site or its ability to achieve its conservation objectives, alone and in-combination. The implementation of the Cable Route Protocol and the decision to amend the plan by not awarding rights to Race Bank Extension was cited as being sufficient mitigation to avoid adverse effects. As such, the Crown Estate was satisfied that there is sufficient scope and flexibility for project specific mitigation measures to be applied at the project level by developers to ensure no adverse effects on integrity.
44. As set out above, HRA will be undertaken for the proposed DEP and SEP, which will include consideration of any necessary mitigation measures to ensure no adverse effect on integrity. This Scoping Request details the information that will be collected to inform the HRA (to be completed alongside the EIA), subject to the outcome of the HRA screening process. The HRA screening process will be completed in due course (see [Section 1.1.4](#)).

#### 1.4 Site Selection and Assessment of Alternatives

45. The offshore scoping area includes the two wind farm AfL areas, interlink cable corridors linking DEP and SEP and offshore export cable corridors from a new offshore substation(s) to each of the potential landfalls. The onshore scoping area includes two potential landfall options, a 500m wide onshore cable corridor and a 3km wide onshore substation search area. These footprints will be refined down to the areas required for the proposed infrastructure as the site selection and impact assessment work progresses and once the landfall has been selected, only one cable route will be taken forward. The final application footprint requirements that are anticipated are described in [Section 1.5](#).
46. This section provides an overview of the main site selection activities that have been undertaken to develop the scoping area for the proposed development; as well as a summary of the alternatives considered. The site selection process is ongoing and will be described in further detail in the ES.

### 1.4.1 Offshore Array Site Selection

47. The DEP and SEP array boundaries were determined following a site selection process that considered The Crown Estate's AfL criteria alongside various environmental, technical and commercial constraints.
48. At the AfL stage, applications were made for two DEP areas to provide flexibility and a sufficiently large area to achieve the required generating capacity. The Dudgeon Extension AfL application therefore includes an extension to the northwest (Dudgeon North) and an extension to the southeast (Dudgeon South) of the existing Dudgeon Offshore Wind Farm (OWF).
49. Key Crown Estate criteria that influenced the site selection process included that wind farm extensions must share a boundary with the existing (parent) wind farm; and that other than the existing wind farm, the proposed extension must not encroach within a radius of 5km of any other wind farm (unless the tenant of any such wind farm confirms its agreement). The latter consideration limited the proposed Sheringham Extension to the west due to an application to extend the Race Bank offshore wind farm from its eastern boundary in the direction of Sheringham Shoal (**Appendix 2, Figure 1.1.1**).
50. Shipping activity was also a key constraint, particularly between the existing Dudgeon and Sheringham Shoal OWFs, which constrained the extensions from Dudgeon to the south and west, and the extension of Sheringham Shoal to the north and east (see **Appendix 2, Figure 2.8.1**).
51. The SEP boundary was chosen to maintain a similar distance from shore as the existing Sheringham Shoal wind farm, which is 17km north of the seaside town of Sheringham at its nearest point to the shore (see **Section 4.1**).
52. Offshore array site selection avoided existing infrastructure where possible. Although it is technically feasible to construct a wind farm around pipelines and cables, the site selection process endeavoured to avoid these and select areas no closer than 500m to existing pipelines and cables where possible. This determined several array boundaries including the eastern boundary of SEP limited by the existing Dudgeon export cable; and the boundaries (north and east) of the northern DEP area limited by existing gas pipelines.
53. Following the site selection process described above, and further refinement following discussion with The Crown Estate and stakeholders, the DEP and SEP areas were selected and included in the AfL applications. The wind farm AfL boundaries as, are illustrated in **Figure 1.1.1** in **Appendix 2**.

### 1.4.2 Grid connection

54. DEP and SEP will both connect to the National Grid at the existing Norwich Main substation. A strategic approach has therefore been taken to identify offshore and onshore cable corridor locations that can accommodate the infrastructure for both Projects with the aim of optimising overall design, minimising impacts and reducing the cost of energy where practicable.

### 1.4.3 Landfall Site Selection

55. Landfall location 'areas of search' were initially identified through constraints mapping and a site walkover by the Project Team.

56. The search area covered the North Norfolk coastline from The Wash to Happisburgh. A landfall south of Happisburgh was considered uneconomical due to the export cable length requiring a change from HVAC to HVDC technology. The site walkover therefore ran from Weybourne to Happisburgh and mapped out urban areas, cliff heights and other relevant constraints along the coastline. Cliff heights above 20m add significant challenges to the engineering design of the landfall, so all areas with cliff heights above 20m were excluded from further consideration. Urban areas were also excluded.
57. The search area was reduced further to exclude the area designated as The Wash and North Norfolk Coast Special Area of Conservation (SAC) due to the recent change in condition status of the SAC. As The Wash and North Norfolk Coast SAC status has changed to unfavourable condition it was decided to not consider an export cable route through the SAC.
58. Therefore the following broad areas were identified as potential landfall areas:
  - Weybourne;
  - Bacton; and
  - Happisburgh.
59. The route to a landfall in the Happisburgh area is considerably longer than the other routes, and a Happisburgh landfall also adds additional onshore length to the export cable. For this reason, the Happisburgh area of search was removed from further consideration at an early stage.
60. At the time of writing this Scoping Report, landfall options at both Weybourne and Bacton remain under consideration.
61. The final landfall location for DEP and SEP will be based on the findings of ongoing consultation, including the EPP, and further technical and environmental surveys and studies in relation to, for example, coastal erosion, archaeological impacts, visual impacts and the Cromer Shoal Chalk Beds MCZ. Therefore this Scoping Report considers both options with the expectation that one will be selected and taken forward in the following stages of the EIA process. The offshore cable corridor will also be further refined through the EIA process, specifically in the inshore area to align with the final landfall location once this has been selected from the two options currently under consideration.

#### 1.4.3.1 Offshore Cable Corridor Selection

62. The offshore export cables will connect to offshore substation(s) located inside the wind farm extension areas. Up to two offshore substations are currently allowed for in the scoping envelope, one in each extension area, as illustrated in **Figure 1.1.1** in **Appendix 2**, with the exact locations still to be confirmed. The two substations would be connected by interlink cables. There is potential for reducing the number of substations to one. If so, this single substation will be located in the SEP area.
63. In the event an offshore substation is required in DEP, array cables will connect the two Dudgeon extension areas to the DEP substation. If only one offshore substation at SEP is required array cables will connect DEP to the offshore substation in SEP.

64. In parallel with the landfall assessment, options for provisional offshore cable corridors were identified from DEP and SEP sites (and indicative offshore substation locations) to each of the two landfall areas of search that remain under consideration, around Bacton and Weybourne (see [Section 1.4.3](#)). Export of electricity to shore from DEP and SEP would follow the same cable route option.
65. The initial site selection strategy was to take the shortest, most direct route between the start and end cable connection points, minimising the footprint of cable installation and thereby minimising impacts and reducing the cost of energy production. Route deviations from this straight line approach were dictated by a variety of constraints. Offshore constraints included in the offshore cable corridor selection exercise were:
- Oil and gas infrastructure including platforms and pipelines;
  - Cables;
  - Aggregate extraction areas;
  - Disposal sites;
  - Shipping and navigation; and
  - Nature conservation designations.
66. Of these, oil and gas pipelines, cables, and nature conservation designations were constraints that resulted in modification of the offshore cable corridor routes. The offshore cable corridors selected for scoping are shown in [Figure 1.1.1](#) in [Appendix 2](#).
67. It was decided to route the Bacton corridor option to the west of the Bacton Gas Terminal gas pipelines, routing to landfall parallel to the Shearwater to Bacton gas pipeline. A landfall option west of the Bacton Gas Terminal avoids multiple pipeline crossings inside the Cromer Shoal Chalk Beds MCZ. After crossing the existing Dudgeon offshore export cable upon exiting the Sheringham Extension area, the Bacton corridor option is routed to the east and parallel to the Dudgeon cable to avoid further crossings.
68. Both corridor options cross the Cromer Shoal Chalk Beds MCZ and the Greater Wash SPA to reach landfall. However, they both take a direct (and therefore shorter) route to shore through the designations to minimise their footprint within them. Furthermore, the corridors widen upon entering the MCZ and the landfall areas, providing additional scope to avoid significant constraints (e.g. designated conservation features) during later route refinement.

#### 1.4.4 Onshore site selection

69. At the time of writing the onshore site selection process is still in progress and the onshore scoping area encompasses a wider study area that will be refined as the site selection and assessment work is progressed. The onshore scoping area has been identified considering physical and environmental constraints, a grid connection at Norwich Main, and two potential landfall locations at Bacton and Weybourne.
70. Key principles that have informed the identification of the onshore scoping area, include:
- Preference for shortest onshore cable to minimise the overall footprints and the number of receptors that will be affected;
  - Avoid key sensitive features, where possible; and



- Avoid populated areas, where possible.

71. The identification of the onshore scoping area has taken into account the following constraints:

- Sites designated for nature conservation (e.g. SPA, Site of Special Scientific Interest (SSSI));
- Sites designated for their landscape (e.g. AONB);
- Historic designations (e.g. listed building or scheduled monuments);
- Residential properties;
- Flood zones / Source Protection Zones (SPZ);
- Contaminated land; and
- Other infrastructure (e.g. buried cables, railways, roads);

#### 1.4.4.1 Grid Connection

72. National Grid is responsible for operating the electricity transmission network in England and Wales. The Connection and Infrastructure Options Note (CION) Process is the mechanism used by National Grid to evaluate potential transmission options to identify the connection point in line with their obligation to develop and maintain an efficient, coordinated and economical system of the electricity transmission network. As part of the economic assessment, the CION considers the total life cost of the connection – assessing both the capital and projected operational costs to the onshore network (over a project's lifetime) to determine the most economic and efficient design option.

73. Following the completion of the CION process National Grid made a grid connection offer in April 2019 for connection at Norwich Main National Grid Substation that would accommodate both Projects. The Applicant accepted this offer in May 2019.

#### 1.4.4.2 Substation and National Grid Infrastructure

74. The Projects will require the construction of an onshore substation that would accommodate both Projects and will also include the electrical infrastructure National Grid requires to connect to the existing electricity transmission network.

75. Some of the onshore substation infrastructure would be shared between the Projects and the number of buildings required would be the same whether one or both projects are progressed. In addition, the infrastructure required by National Grid would be the same for one or two projects (a single bay connection).

76. Planning advice on the siting of onshore substations is set out by National Grid in the 'Horlock Rules' (National Grid, undated). The Horlock Rules are a set of guidelines produced by National Grid to assist those responsible for siting and designing substations to mitigate the environmental effects of such developments (National Grid, 2003). They are still referred to and used by National Grid when undertaking planning studies for new infrastructure although they now have to be considered alongside other guidance in NPS and the National Planning Policy Framework (NPPF).

77. The principles set out in the Horlock Rules are relevant to the infrastructure at the onshore substation and have been taken into consideration in defining the onshore study area and will inform the ongoing site selection process. Key considerations include:
- Siting should, as far as reasonably practicable, seek to avoid internationally and nationally designated areas of the highest amenity, cultural or scientific value;
  - Areas of local amenity value, important existing habitats and landscape features including ancient woodland, historic hedgerows, surface and ground water sources and nature conservation areas should be protected as far as reasonably practicable;
  - The siting of substations etc. should take advantage of the screening provided by landform and existing features and the potential use of site layout and levels to keep intrusion into surrounding areas to a reasonably practicable minimum;
  - The proposals should keep the visual, noise and other environmental effects to a reasonably practicable minimum; and
  - The land use effects of the proposal should be considered when planning the siting of substations or extensions.
78. A 3km search area has been identified around the existing National Grid connection point at Norwich Main, within which a detailed site selection exercise will be undertaken for the location of the onshore substation. Consideration will be given to placing the electrical infrastructure as close as possible to the existing National Grid connection point (where feasible) in order to minimise the landscape and visual effects associated with introducing new electricity infrastructure to the environment.

#### 1.4.4.3 Onshore Cable Route

79. The location of the onshore cable corridors to inform scoping were identified as part of an initial site selection process considering various possible onshore routes for DEP and SEP.
80. The process was largely driven by the location of the endpoints, i.e. the two potential landfall areas and the connection location at Norwich Main. The initial feasibility and route selection exercise has identified a 500m wide onshore cable corridor.
81. This corridor will be further refined as site selection progresses to identify a 100m wide corridor suitable for the required EIA surveys, e.g. onshore ecology surveys. The findings of those surveys and the impact assessment work will continue to inform site selection and allow a further refinement down to the 45m wide corridor that is required for the application.

## 1.5 Proposed Development Description

### 1.5.1 Introduction

82. This section provides an overview of DEP and SEP. It sets out the design and main components of the offshore wind farms and their infrastructure. It also describes the key activities that will be undertaken during construction, operations and maintenance (O&M phase) as well as decommissioning.



- 83. At this early stage the project description is indicative for the purpose of informing the scoping exercise. The description has been designed to include enough flexibility to accommodate further refinements during site selection and detailed design.
- 84. The project description will be further developed through the EIA process; in the next stage within the PEIR; and finally, within the Environmental Statement that will accompany the application for Development Consent.
- 85. **Table 1-3** provides an overview of the key components of DEP and SEP.

*Table 1-3 UK Extension Overview*

Infrastructure	Component	Detail
<b>Wind farm array</b>	Wind turbines	The wind turbines convert wind energy to electricity. Key components include rotor blades, gearboxes (in some cases), transformers, power electronics and control equipment. Offshore turbine models are continuously evolving and improving, therefore the exact wind turbine model will be selected post-consent from the range of models available at the point of procurement.
	Wind turbine and offshore substation foundations	The wind turbines and offshore substation/s will be permanently attached to the seabed with foundation structures. The foundation structures are either anchored down into the seabed by means of piling or suction buckets or sit on the seabed anchored by gravity only. These are typically fabricated from steel or concrete. A limited number of foundation designs are under consideration.
	Array cables	Array cables will connect the wind turbines to one of the offshore substations. Cables will be buried to the extent possible.
	Offshore substation/s	One or two substations to convert the power to higher voltages in order to transmit the power more efficiently (reduced electrical losses) to shore.
	Interlink cables	In order to improve the reliability of the transmission system, interlink cables may be installed connecting the offshore substations to each other.
	Cable protection	If soil conditions make burial unfeasible, as well as in the immediate proximity of turbine foundations, cables may be protected by a hard-protective layer such as rock or concrete mattresses.
<b>Offshore export cables</b>	Export cables	Cables connecting the offshore substation(s) to the landfall. Cables can be delivered in sections and jointed in-situ or be delivered in one length (factory joined).
<b>Scour protection</b>	Scour protection	In order to protect the seabed around foundation structures and cables from scour, scour protection

Infrastructure	Component	Detail
		(rocks or other materials) may be placed on the seabed to protect from current and wave action.
<b>Onshore</b>	Export cables	Buried cables connecting the landfall to the onshore substation at Norwich Main. Cables will be delivered in sections and buried in trenches. Sections will be connected together within jointing bays.
	Onshore substation	An onshore substation will be located as close as practical to the National Grid substation at Norwich Main and will include all necessary electrical and auxiliary equipment to meet the requirements of the National Grid 'Grid Code'.
	Energy balancing infrastructure	The onshore substation may incorporate energy balancing / storage infrastructure, such as a battery.
	Grid connection	DEP and SEP will connect to the national grid in the existing National Grid Electricity Transmission (NGET) substation at Norwich Main.

### 1.5.2 Design Envelope Approach

86. The use of the Design Envelope approach has been recognised in the Overarching National Policy Statement (NPS) for Energy (NPS EN-1) (DECC, 2011a) and the NPS for Renewable Energy Infrastructure (NPS EN-3) (DECC, 2011b). This approach has been used in all offshore wind farm DCO applications to date.
87. In the case of offshore wind farms, NPS EN-3 (paragraph 2.6.42) recognizes that: "Owing to the complex nature of offshore wind farm development, many of the details of a proposed scheme may be unknown to the applicant at the time of the application, possibly including:
- Precise location and configuration of turbines and associated development;
  - Foundation type;
  - Exact turbine tip height;
  - Cable type and cable route; and
  - Exact locations of offshore and/or onshore substations.
88. NPS EN-3 (paragraph 2.6.43) continues:  
 "The Secretary of State should accept that wind farm operators are unlikely to know precisely which turbines will be procured for the site until sometime after any consent has been granted. Where some details have not been included in the application to the Secretary of State, the applicant should explain which elements of the scheme have yet to be finalized, and the reasons." Therefore, some flexibility may be required in the consent.
89. NPS EN-3 also states that: "The 'Rochdale [Design] Envelope' is a series of maximum extents of a project for which the significant effects are established. The detailed design of the project can then vary within this 'envelope' without rendering the ES [Environmental Statement] inadequate".

90. The Design Envelope approach is widely recognised and is consistent with Planning Inspectorate (PINS) Advice Note Nine: Rochdale Envelope (PINS, 2017c) which states that: “The ‘Rochdale Envelope’ is an acknowledged way of dealing with an application comprising EIA development where details of a project have not been resolved at the time when the application is submitted”.
91. Throughout the Scoping Report and subsequent EIA, the Design Envelope (otherwise known as the "Rochdale Envelope") approach has been taken to allow meaningful assessments of DEP and SEP to proceed, whilst still allowing reasonable flexibility for future project design decisions.

#### 1.5.2.1 Applying the ‘Rochdale Envelope’ Approach

92. Flexibility to respond to emerging economic circumstances and technological advances is essential if DEP and SEP are to proceed and be successful. A degree of flexibility will, therefore, be built into the design basis for the Development Consent Order application by applying a Rochdale Envelope approach that is consistent with PINS Advice Note Nine (PINS, 2017c).
93. This approach does introduce some complexity into the EIA process common to many large-scale developments, which are dependent on market conditions for their delivery. The 2017 Regulations require an Environmental Statement to provide a description of the location, design and size of the scheme to enable the likely significant environmental effects to be assessed and to enable the decision-maker, statutory consultees and the public to make properly informed responses.
94. A balance has to be sought between defining the proposals in enough detail to predict their impacts, while leaving enough flexibility to enable DEP and SEP to be successfully delivered under conditions which may be subject to change. The design parameters will provide an ‘envelope’ as a basis for the impact assessment process.
95. Such an approach is a recognised practice, as reflected in case law on the ‘Rochdale Envelope’ principle. Suitably applied in EIA it can help to avoid the need for protracted re-submission procedures at a later stage, whilst giving a comprehensive assessment of the likely environmental effects.

#### 1.5.3 Project infrastructure overview

96. An illustration of the main components of DEP and SEP is provided on **Figure 1.5.1** in **Appendix 2**.

Figure 1.5-1: Project infrastructure

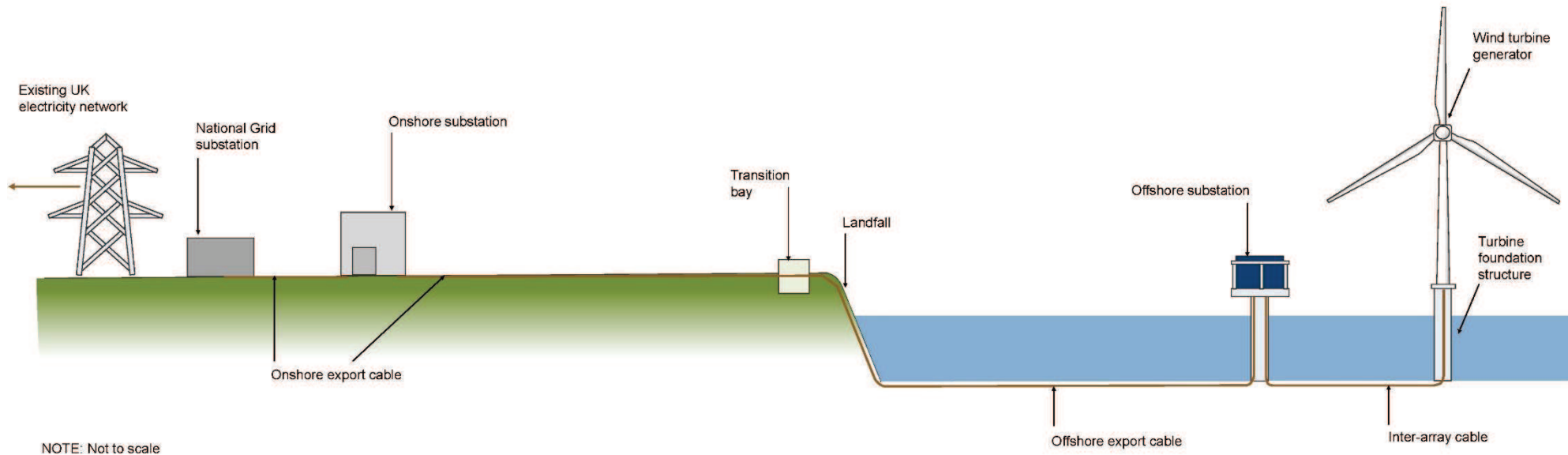

## 1.5.4 Wind farm sites

### 1.5.4.1 Lease area

97. DEP and SEP consists of two extension assets and thus Agreement for Lease areas as illustrated in the map in **Figure 1.1.1** in **Appendix 2**. The DEP area is divided into two parts – DEP north and DEP south. The key characteristics of each area are summarised in **Table 1-4**.

*Table 1-4 Dudgeon and Sheringham Extensions Overview*

Area	Parameters	Values
SEP	AfL area	92.6km <sup>2</sup>
	Closest distance to shore	17.5km
	Water depth	14 - 25m
DEP	AfL area	103.5km <sup>2</sup>
	Closest distance to shore	31km
	Water depth	11 - 23m

### 1.5.4.2 Wind measurements

98. DEP and SEP are located adjacent to the operating Sheringham Shoal and Dudgeon Offshore Wind Farms. Wind and metocean data exist for the operational assets and will be used to support the planning of DEP and SEP. However, it may also be necessary to collect additional site-specific data for DEP and SEP. If wind measurements are needed this will be collected through the use of up to two floating LIDARs inside the respective AfL areas. The installation of floating LIDARs will be subject to separate marine licences and will be dealt with under a marine license application process, not the DCO process.

### 1.5.4.3 Wind Turbine Generators

99. The size and capacity of the wind turbines will be decided at a later point in time, prior to final investment decision. Technology develops rapidly and available sizes of turbines are expected to increase over the coming years. The current wind turbine design envelope for DEP and SEP is outlined in **Table 1-5** and illustrated in **Figure 1.5.3**.

*Table 1-5 Wind Turbine Design Envelope*

Parameters	Indicative range
<b>Rotor Diameter</b>	~220 – 300m
<b>Number of wind turbines – DEP</b>	Up to 34 turbines
<b>Number of wind turbines – SEP</b>	Up to 27 turbines
<b>Max Tip Height (HAT)</b>	Up to ~326m
<b>Air Gap above Highest Astronomical Tide (HAT)</b>	Lowest air gap ~22m

Parameters	Indicative range
<b>Indicative separation distance between turbines (inter-row), DEP and SEP</b>	Shortest distance between turbines ~ 990m (4.5 rotor diameters)

Figure 1.5.2 Turbine schematics. 1: Max tip height above highest astronomical tide (HAT). 2 – Rotor diameter is diameter of circle, swept area is area inside circle. 3 – Air gap above HAT.

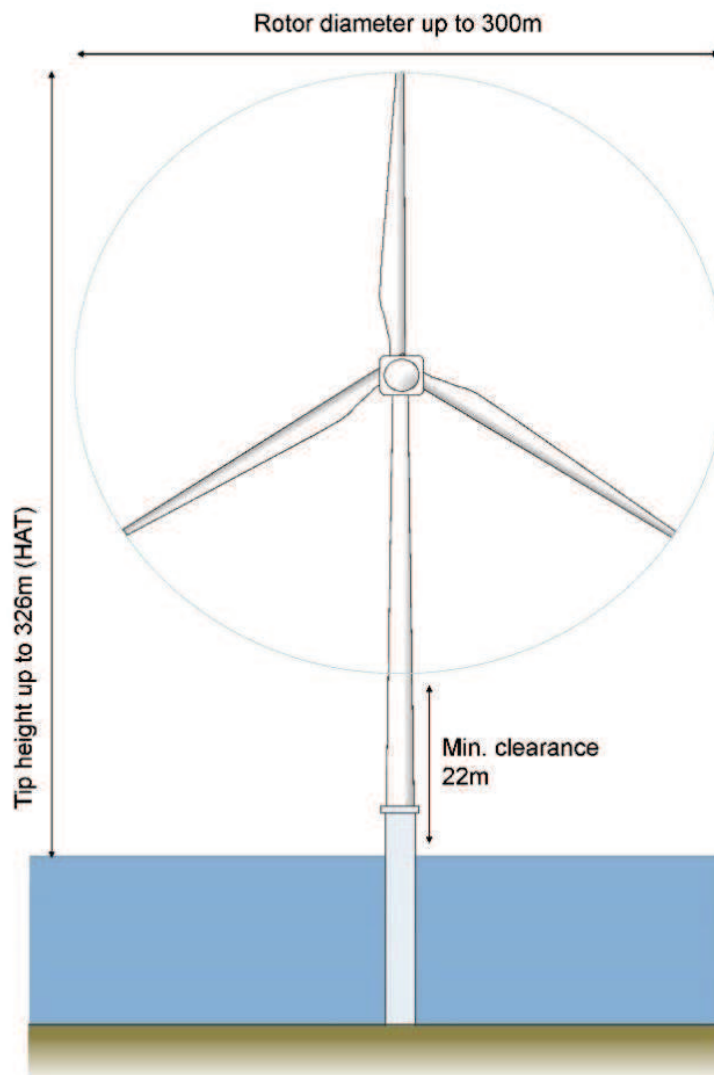

#### 1.5.4.4 Wind Turbine Foundations

100. The wind turbine foundation type will be selected based on the results from the geotechnical investigations, wind turbine selection, metocean data, environmental considerations and the market situation for fabricating wind turbine foundations.

101. Available wind turbine foundation types are:

- Monopile/Transition Piece concept (MP/TP concept);
- Mono tower with suction bucket;
- Jacket with pile;
- Jacket with suction bucket; and
- Gravity based structures (GBS).

102. Monopiles are usually constructed from welded steel tubular sections and driven vertically into the seabed using piling hammers. In challenging soil conditions piles may be drilled into the seabed. The MP/TP concept is considered to be feasible for turbines up to 12-14MW, but might also be feasible for larger turbines.

103. A suction bucket is based on a structure comparable to an upturned bucket that is lowered to penetrate into a pre-prepared (levelled) seabed. The monotower with suction bucket can be used for turbines up to 12-14MW, and possibly for larger turbines as well. Other than seabed surface preparation, the installation process does not result in the generation of spoil, nor does it require piling. It is, however, sensitive to the ground conditions.

104. A jacket foundation typically consists of three or four main legs which are linked by a supporting matrix of cross-braces. Jacket foundations are anchored to the seabed by using single piles or suction buckets at each leg.

105. Piled jacket foundations are currently the preferred foundation solution for larger turbines in deeper waters.

106. A gravity-based foundation sits on the seabed and is typically a heavy ballasted structure made of steel and/or concrete. They can vary in shape, but will have a base diameter of up to 50m. The gravity base structure is placed on a pre-prepared area of seabed which may include removal of soft, mobile sediments and the levelling of an area by installation of a layer of rock/gravel. The diameter of the levelled seabed area may reach up to 100m. A gravity foundation is suitable for large turbines and deep waters.

107. The wind turbine foundation alternatives are illustrated in [Figure 1.5.3](#) and parameters listed in [Table 1-6](#).



Figure 1.5.3 Wind turbine foundation types

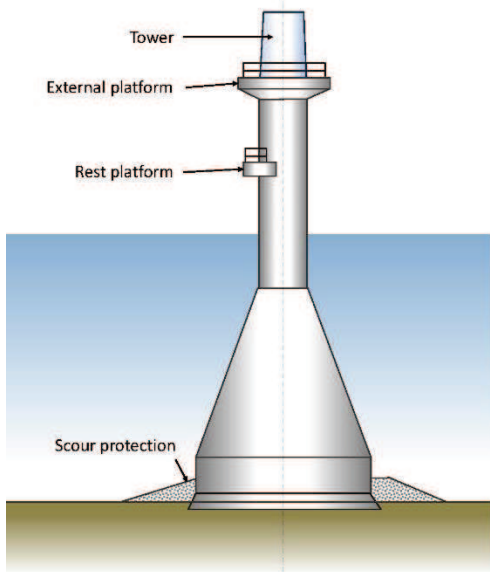

**Gravity base**

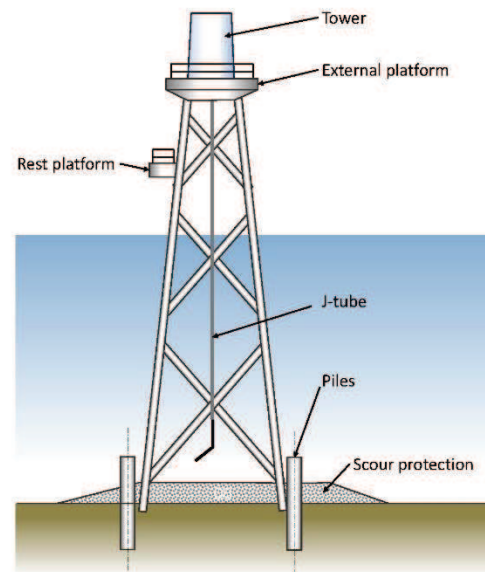

**Jacket with piles**

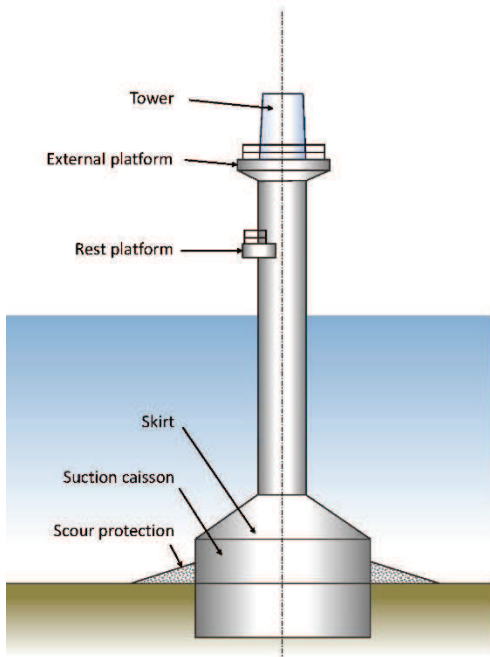

**Suction bucket**

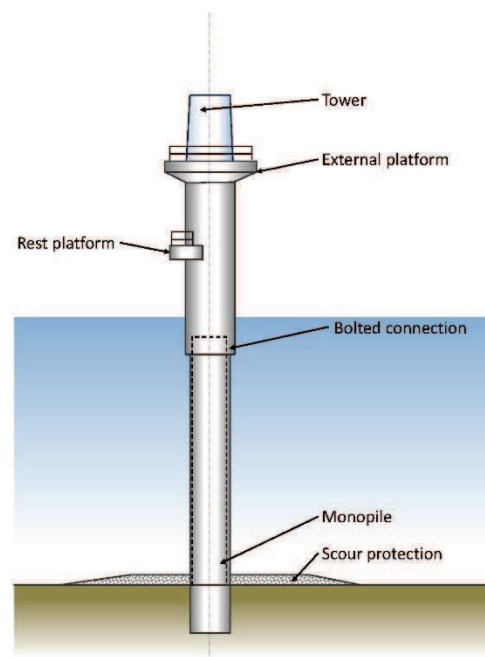

**Monopile**



Table 1-6 Wind turbine foundation design envelope

Foundation type	Parameter	Indicative size
Monopile/Transition piece	Diameter	Up to 12m
	Hammer size	Up to 4500kJ
Jacket with piling	Leg spacing	< 30m
	Hammer size	< 3000kJ
Jacket with suction bucket	Leg spacing	< 35m
	Bucket diameter	< 20m
Gravity based structure	Diameter	< 50m
Mono tower with suction bucket	Diameter	< 30m

### 1.5.5 Electrical system

108. The electrical transmission system will collect the power produced at the wind turbines and transport it to the UK electricity transmission network. The transmission system will be constructed by Equinor and the ownership will be transferred to an Offshore Transmission Operator (OFTO) in accordance with applicable rules and regulations in a transaction managed by the Office of Gas and Electricity Markets (Ofgem).

#### 1.5.5.1 Array cables

109. Array cables connect the turbines to each other and to the offshore substation. Cable system design will be based on radial strings from the offshore substation(s) and connecting multiple turbines per string. The current design also includes three additional array cables on DEP and two additional array cables on SEP to be used as links between radials. The array cables are expected to be 66kV AC. The length of each array cable, and string, will depend on the distance between the turbines and the distance between the first turbine on the string and the offshore substation. A realistic maximum distance of array cables will be defined for the purposes of the EIA and used as the basis for the assessments.

110. Array cables will connect DEP to the offshore substation located in the SEP area (in case there is only one offshore substation). Indicative array designs will be used to inform the definition of the worst-case parameters of array cables.

#### 1.5.5.2 Offshore substation(s)

111. The cables from a string of turbines will be brought to an offshore substation, located appropriately to optimise the array cable and export cable lengths. At the substation, the generated power will be transformed to a higher AC voltage. This higher voltage will be determined by detailed studies, but is likely to be ~ 220kV.

112. There will be up to two offshore substations. In the case there are two substations being constructed there will be one substation located in each extension area, see **Figure 1.1.1**. The location of the offshore substation/s will be confirmed during the detailed design process but will be within the limits of each wind farm site.

113. The offshore substation foundation type will likely be a jacket or a GBS foundation. The jacket foundation will have 4 or 6 legs with up to three piles at each leg or one suction bucket at each leg. Leg spacing at the seabed will be up to 40m. In case of a GBS foundation the diameter of the foundation at seabed will be up to 50m.

### 1.5.5.3 Array cables

114. Cable system design will be based on radial strings from the offshore substation(s) and connecting multiple turbines per string. Array cables connect a turbine to the next turbine and the number of array cables will therefore be equal to number of turbines. The current design also includes three additional array cables on DEP and two additional array cables on SEP to be used as links between radials. The array cables will be 66kV AC. The length of each array cable, and string, will depend on the distance between the turbines and the distance between the first turbine on the string and the offshore substation.

115. Array cables will connect DEP to the offshore substation located in the SEP area (in case there is only one offshore substation). The current design accounts for up to 6 array cables linking DEP to the offshore substation at SEP. Each cable will require its own trench, totalling up to six trenches.

### 1.5.5.4 Interlink cables

116. Should the final design of DEP and SEP include two substations, up to two interlink cables may be installed to link the two substations. The interlink cables will improve the reliability of the transmission system. They will be 220kV AC cables and will be installed in separate trenches.

### 1.5.5.5 Offshore export cables

117. Two export cables (220kV AC) are likely to run from the offshore substation(s) to a transition joint bay at the landfall. The transition joint bay connects the offshore and onshore export cables. Each export cable will be installed in a separate trench and protected in line with good industry practice.

118. The export cables will be installed in separate installation campaigns as the installation vessel only can install one cable at the time. Installation of offshore cables typically takes place by ploughing or trenching depending on the soil conditions along the cable route. The purpose of cable burial is to ensure that the cables are protected from damage by external factors. Typical burial depth is between 0.5 to 1.5m, but no protection will also be considered. The appropriate level of protection will be determined based on an assessment of the risks posed to the project in specific areas.

**Table 1-7** describes the main cable parameters.

119. It is likely that the export cables will have to cross other cables and/or pipelines. Detailed methodology for the crossing of cables and pipelines by the export cables will be determined in collaboration with the owners of the infrastructure to be crossed. A number of techniques can be utilised, including:

- Pre-lay and post lay concrete mattresses;
- Pre-lay and post lay rock dumping;
- Pre-lay steel structures; or

- Other appropriate approaches.

120. There will be no separate cables for fibre optics. Fibre optics will be integrated with the export cables.

*Table 1-7 Offshore cable parameters (based on an HVAC export cable system)*

Item	Indicative parameters
DEP array cables	One per wind turbine plus potential cables for redundancy between strings
SEP array cables	One per wind turbine plus potential cables for redundancy between strings
Cables connecting DEP and SEP (array or interlink)	Up to 8
Export cables/trenches	Up to 2
Fibre optic cables	Bundled in export cable
Number of cable crossings	Up to 6
Length of cables	
Array cables	Dependent upon distance between turbines
DEP – SEP	Up to ~ 20km
Export cable SEP – Weybourne	~18km
Export cable SEP – Bacton	~30km
Export cable route scoping width	~500m – 1,000m (1,000m through the MCZ)

### 1.5.5.6 Landfall

121. There are currently two alternative landfall options (Weybourne and Bacton), as illustrated in **Figure 1.1.1** in **Appendix 1**. As described in **Section 1.4**, a preferred landfall will be selected during the EIA process. Cable installation methodology at the landfall will be selected based on a comparative assessment of impacts. It is assumed that suitable technologies may include open cut trenching or horizontal directional drilling (HDD). The offshore and onshore cables will be jointed in one or two transition bays onshore. **Table 1-8** shows the main construction parameters for the landfall site.

122. Open cut is a well-known installation methodology for underground cabling in relatively unconstrained areas. It can also be used to install cables in a landfall and would require an open trench to be dug out before cables are installed and the trench refilled.

123. If HDD is chosen as the appropriate installation methodology at the landfall, each export cable will require one HDD i.e. up to two in total. However, a spare HDD is accounted for in the scoping envelope. The HDD is drilled from an onshore construction compound and will exit the seabed in an exit pit at a suitable site with 8 – 10m water depth. The length of the HDD will depend upon factors such as water depth, seabed topography, shallow geology/soil conditions and environmental constraints. The onshore construction compound will be temporary in nature and reinstated after completion of the project.
124. The exit pits offshore of the HDDs will be spaced some distance apart, typically 20 – 50m. However, environmental and technical constraints may guide the actual separation distance to be used. The exit pits are likely to be 3m wide at the bottom to allow collection of drilling fluids. The total length will be approximately 10m, while the depth of the exit pits will reflect the depth at which the export cable will continue further offshore. However, it is likely that depths will be less than 1m. The export cables are generally protected in the HDD exit pits and in the offshore export cable trench. However, there is a section between the HDD exit pit and the cable trench of up to 50m where the export cables are not naturally protected. This stretch may require additional permanent protection measures in the form of rock protection. For the purposes of the EIA appropriate protective measures will be identified and discussed with key stakeholders prior to submission of the DCO application.
125. The onshore transition bay(s) will be located underground. A pit will be dug out and refilled once the transition bay(s) have been installed.

*Table 1-8 Landfall construction parameters*

Landfall	Indicative parameters
Number of HDD drills	Up to 3
Number of transition bays	Up to 2
Transition bay dimensions (length x width)	Up to 20 x 20m
Transition bay dimensions depth	Up to 2m
Landfall HDD compound (length x width)	Up to 80 x 80m
Length of HDD	Up to 1,500m

### 1.5.5.7 Onshore Export System

126. The width of the onshore cable corridor swathe will be up to 45m, increasing up to 60m at trenchless crossings (e.g. HDD). This increase allows for additional separation of cables buried at depth. This width accounts for the required construction footprint, including trenches, haul road, spoil storage, drainage etc.
127. The onshore underground cable system will be installed in trenches, either a common trench for the two circuits or one circuit per trench. Each circuit consists of three high voltage cables and one fibre optical cable. A trench holding two circuits may be up to 5m wide. A trench holding a single circuit may be up to 2.5m wide with approximately 5m separation distance between the trenches. A typical installation will require minimum 1m distance between the cable circuits. The required distance between cable circuits will be increased for deeper installations, typically up to 10m for trenchless crossings.

128. Jointing bays will be used to pull the cables into the ducts and/or to join the cable lengths to each other. Link boxes are used for earthing cables and will be installed inside a protective concrete chamber. The jointing bays are subsurface structures, while the link boxes will require access (for inspections) from the surface during operations and will therefore be located at or above ground level. At the jointing location there will be one link box per circuit. The frequency of jointing bays and link boxes will vary between 300 – 1000m.

*Table 1-9: Onshore cable parameters*

Onshore cable corridor	Indicative parameters
Cable corridor swathe width	Up to 45m
Cable corridor swathe at trenchless crossings	Up to 60m
No. cables	Up to 12
No. ducts	Up to 12
No. trenches	Up to 2
Depth to top of buried infrastructure (ducts)	>1m
Trenchless (HDD) crossings	To be identified
Trenchless (HDD) crossings compound (length x width)	Up to 100 x 50m
Typical jointing bay frequency	Up to every 300m
No. jointing bays per location	One per trench
Jointing bay (length x width x height)	Up to 20 x 10 x 1.5m
Depth to top of jointing bay (m)	> 1m
Link box frequency	Up to every 300m
Link box (length x width)	Up to 2 x 2m

### 1.5.5.8 Onshore Substation

129. An onshore substation will be constructed to accommodate the connection of both DEP and SEP to the transmission grid. The HVAC onshore substation will be located in proximity to National Grid’s existing Norwich Main substation. It will contain the necessary electrical and auxiliary equipment and components for transforming the power from the wind farm to 400 kV and required to meet the UK Grid Code for connection to the transmission grid.

130. The maximum design scenario will be set out in the PEIR (e.g. max height, footprint, number and type of buildings). **Table 1-10** describes the main onshore substation construction parameters.

131. The outlined operational footprint of 200 x 200m does not necessarily take possible landscaping needs into account. The need and location of landscaping activities will be identified and agreed with relevant stakeholders at a later stage.

132. In case the DEP and SEP onshore substation is located adjacent to the existing Norwich Main substation, an overhead connection between the two substations will be considered. An underground cable connection will be used if the two substations are not adjacent to each other. The cable corridor between the two substations will be similar to the export cable corridor in design and width.

### Energy Balancing Equipment

133. Energy and grid balancing equipment is becoming increasingly widespread to effectively and cost efficiently balance the supply and demand of electricity within the electrical transmission network as well as offer grid services and thus increase the overall reliability of the system. Since this is a rapidly evolving field a range of technologies are under development and will be considered and assessed within the Environmental Statement. The system could be housed in single or multiple building(s), several containers, in an open yard or a combination of the above.

134. All energy balancing equipment – if designed in - will be housed within the footprint of the onshore substation as defined at PEIR.

*Table 1-10 Onshore substation construction parameters*

Substation	Indicative parameters
Construction compound (length x width)	Up to 150 x 150m
Operational compound (length x width)	Up to 200 x 200m
Building height	Up to 25m
External equipment height	Up to 30m

#### 1.5.5.9 Grid Connection

135. DEP and SEP will both connect to the existing transmission grid in National Grid’s Norwich Main substation. The requirement for any NGET substation consents necessary to undertake works associated with DEP and SEP at Norwich Main is the responsibility of National Grid. The cumulative impacts will be considered as appropriate.

### 1.5.6 Offshore and onshore construction

#### 1.5.6.1 Fabrication

136. All elements of the offshore wind farm including turbines, foundations, substations and electrical infrastructure will be fabricated offsite, stored at a suitable port facility and transported to site as needed. Fabrication contracts have not been placed and Equinor will run competitive tendering processes to identify the best suitable contractors to deliver the different elements of the development. Fabrication can take place in the UK, in Europe or elsewhere dependent upon the location of the chosen contractor.



### 1.5.6.2 Seabed preparation

137. Some form of seabed preparation may be required for each foundation type. Seabed preparation includes seabed levelling, ground reinforcement and removing surface and subsurface debris such as boulders, fishing nets, lost anchors etc. If debris are present below the seabed surface then excavation may be required for access and removal. Any unexploded ordnances found with live ammunition will be detonated and any remaining debris removed, where practicable.
138. Consent for UXO removal will be sought in a future Marine Licence application, when geophysical survey data of suitable spatial resolution is available to identify and quantify UXO risk.

### 1.5.6.3 Marine operations

139. Equinor gained extensive knowledge and experience of undertaking construction work in this area from the Dudgeon and Sheringham Shoal construction campaigns. This experience will be drawn upon and used in planning and execution of the construction activities of DEP and SEP.
140. Monopiles can be installed by using floating mono hull crane vessels or suitable jack-up vessels for these water depths and conditions. The contractor market has developed in recent years and there are several new installation vessels being planned or constructed which will be suitable for DEP and SEP.
141. It is expected that max hammer size for pile driving will be 4500kJ.
142. The vessels undertaking the piling of the monopiles will also be likely to install the transition pieces (TPs). There are currently initiatives looking into possible alternative solutions for construction, including the installation of a combined monopile and TP. The Applicant will follow this technology development closely and identify a construction philosophy which best takes all aspects into account.
143. Foundations and turbines are likely to be installed by using jack-up vessels. For the larger new turbines the market for installation vessels is limited, but it is expected that the availability of installation vessels will adapt to the increase in turbines sizes. Details of the anticipated jack-up operation footprints will be considered in the PEIR.

### 1.5.6.4 Onshore cable route

144. The onshore cable ducts will be installed using a trenching machine/open-cut trench techniques; and where necessary HDD or other trenchless methods to avoid surface disturbance at sensitive features. The cables will be direct laid or installed in ducts at the bottom of the trench(es).
145. The Cable burial includes the removal of topsoil, excavating the trench, installing the ducts and backfilling the trench. The cables will be pulled through the ducts after the trench has been backfilled. Cables and ducts are likely to be covered by approximately 1m soil. The cable route width of 45m takes account of the need for storing soils during construction.



146. Haul roads will be constructed along the cable route to allow access to the cable route during the construction phase. In the case of a phased development the haul roads may be left in situ between construction periods and removed once construction of the phased development has finalised. The cable route width of 45m takes account of the need for haul roads.
147. There will be need for several temporary compounds along the onshore cable corridor for material and equipment
148. **Figure 1.5.2** shows a typical open trench arrangement showing the duct installation during construction. The picture shows installation of ducts for two circuits in a tree folio arrangement (3 cables per circuit).
149. **Table 1-9** details the main onshore cable construction parameters.

*Figure 1.5-4 Duct installation during construction (open cut trench)*



#### 1.5.6.5 Trenchless crossings (including landfall)

150. Where an open trench approach is not possible due to significant obstructions (e.g. a major road or watercourse or at the landfall) non-trenching techniques will be employed. It is anticipated that HDD technique or similar will be used.
151. The HDD method comprises three stages:
- A pilot hole is drilled between the entry and exit point;
  - The hole is enlarged by passing a larger cutting tool through known as the back reamer; and
  - The cable duct is placed in the enlarged hole.
152. HDD is undertaken with the help of a drilling fluid, which is usually a mixture of water and bentonite (an inert clay-based material). During drilling the drilling fluid is continuously pumped to the cutting head or drill bit to facilitate the removal of cuttings, stabilise the borehole, cool the cutting head, and lubricate the passage of the product pipe.
153. Use of any trenchless technique will also require temporary construction compounds at the entry and exit points.

#### 1.5.6.6 Onshore substation

154. Construction of the onshore substation will include:

- Establishing access roads;
- Site preparation/levelling for the temporary construction compounds and the permanent substation site. Dependent upon the onsite ground conditions at the substation location, piling may be required to support the construction of buildings and heavy equipment;
- Installation of underground utility/drainage and foundations for buildings and equipment;
- Construction of building(s) and installation of electrical equipment;
- Installation of permanent perimeter fencing around entire substation; and
- Landscaping to minimise visual impact.

### 1.5.7 Construction Program

155. The indicative high-level construction programs shown in **Figure 1.5-5** and **Figure 1.5-6** provide an overview of installation durations of the main project elements under the integrated and separated grid options respectively. The worst case scenario presented by the construction program will differ according to the receptor and impact in question (which, as set out in **Section 1.6**, will be identified in the EIA and assessed accordingly). **Figure 1.5-3** therefore shows construction activities undertaken as a single construction campaign for DEP and SEP, but also a program where construction activities are undertaken as two separate campaigns approximately 2 – 3 years apart.

Figure 1.5-5 Construction Program Integrated Grid Option

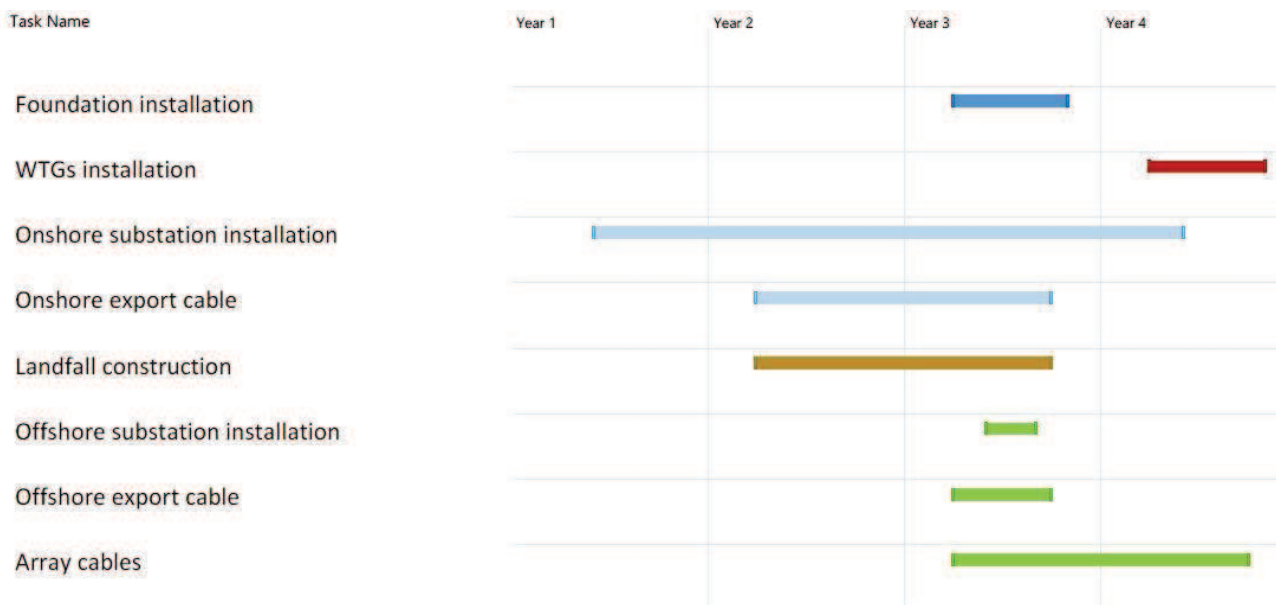
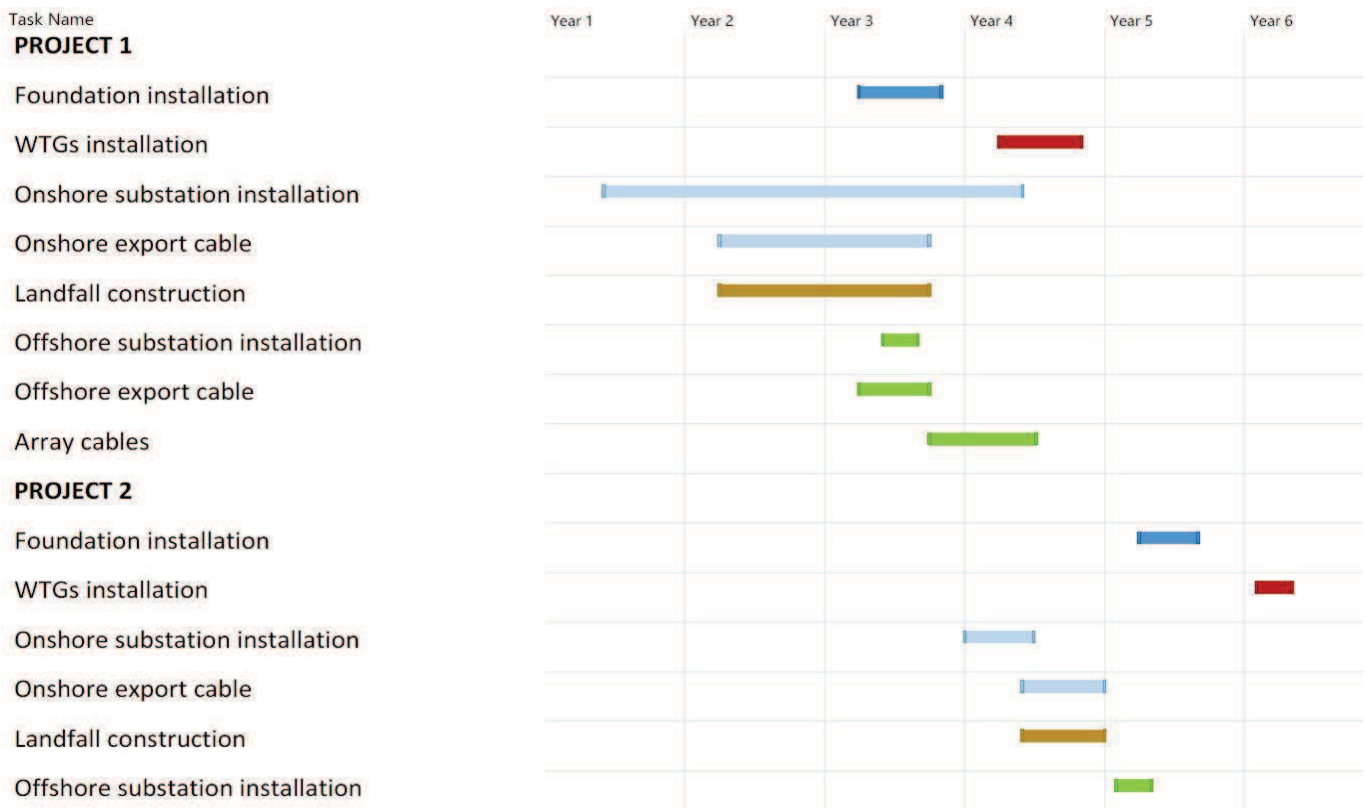

Figure 1.5-6 Construction Program Separated Grid Option



### 1.5.8 Operation, Maintenance and Decommissioning Phases

156. The Applicant will leverage the experience from the existing O&M organisations at Great Yarmouth and Wells-next-the Sea. Synergies will be identified and sought to be incorporated into the O&M strategy for DEP and SEP.
157. The overall operations and maintenance (O&M) strategy will be finalised once the technical specification is known, including wind turbine type, electrical transmission design and final project layout.
158. The general O&M strategy will rely primarily on crew vessels, supply vessels, and helicopters for the O&M services that will be performed at the wind farms.
159. Maintenance activities will be categorised into two levels: preventive and corrective maintenance. Preventive maintenance will be undertaken according to scheduled services whereas corrective maintenance would be needed to cover unexpected repairs, component replacements, retrofit campaigns and breakdowns.
160. At the end of the operational lifetime of the wind farm, assumed to be minimum 30 years, it is anticipated that all offshore structures above the seabed (foundations and electrical infrastructure) will be removed and the site of the onshore substation will be restored. All electrical cables will be left in-situ to minimise environmental impacts associated with their removal. The decommissioning sequence will take approximately three years and will be undertaken in reverse of the construction sequence, involving similar types and numbers of vessels and equipment. The decommissioning plan and program will be developed prior to construction and be updated during the projects' lifespan to take account of changing best-practice and new technologies.

## 1.6 EIA Methodology

### 1.6.1 Introduction

161. The EIA will be undertaken in accordance with the Planning Act 2008 and the EIA Regulations (see **Section 1.3**). Furthermore, the approach to the EIA and the production of the resulting ES document will closely follow relevant guidance including:
- Overarching National Policy Statements for Energy EN-1, Renewable Energy Infrastructure EN-3, and Electricity Networks Infrastructure EN-5 (DECC, 2011b);
  - Assessment of the environmental impact of offshore wind-farms (OSPAR Commission, 2008);
  - Planning Inspectorate Advice Notes (e.g. the Planning Inspectorate, 2017a; 2017b; 2017c; 2018a; 2018b);
  - Relevant guidance issued by other government and non-governmental organisations; and
  - Receptor/topic specific guidance documents.
162. It will also have due regard to the requirements of the Habitats and Species Regulations 2010, The Offshore Marine Conservation (Natural Habitats, &c.) (Amendment) Regulations 2017 and the Marine and Coastal Access Act 2009.
163. The outputs of the EIA will be presented in a Preliminary Environmental Information Report (PEIR) and thereafter the final ES and associated documents in support of the application for development consent. It is intended that the PEIR will be a draft ES and will include full assessments for topics wherever possible to maximise stakeholder consultation and subsequent input prior to application. The final ES will update the assessments to take account of any final information and stakeholder feedback.

### 1.6.2 Stakeholder Consultation

164. Regular consultation with stakeholders is key to the success of the EIA process and will be undertaken throughout the assessment and site selection work. An Evidence Plan Process (EPP) has been set up and will be followed during the EIA to structure some of the technical stakeholder consultation where there are multiple interested parties. This process has been initiated during the production of this Scoping Report, with the first Steering Group meeting (attended by the MMO, Natural England and Norfolk County Council alongside Equinor and its advisors) being held in July 2019.
165. The EPP is a voluntary mechanism to help agree the information required by the Planning Inspectorate as part of an application for development consent to help ensure compliance with the EIA Regulations and Habitats Regulations. The EPP aims to give greater certainty to all parties on the nature, amount and range of evidence the Applicant should collect and present to support the application.
166. The EPP will include expert topic group (ETG) meetings that provide a platform to debate advice on each topic between multiple agencies. The process will be monitored by a steering group and will be formulated to meet the requirements of the Planning Act 2008 (see **Section 1.6.4**).

167. Ongoing discussions will be minuted to log areas of agreement/disagreement on key aspects of the EIA, such as data acquisition, survey methodologies and approach to assessment, data analysis results and impact assessment outcomes to ensure the EIA is as robust as possible. The approach provides increased certainty to key stakeholders on the amount and range of evidence to be presented within the application, as well as enabling the Applicant to address issues early in the pre-application stage.

### 1.6.3 Characterisation of the Existing Environment

168. The characterisation (description) of the existing environment will define the existing conditions in the area covered by DEP and SEP and relevant surrounding study areas. This will comprise the following steps:

- Study areas will be defined for each receptor based on the relevant characteristics of the receptor (e.g. mobility/range);
- Review of available existing information;
- Review the likely or potential impacts that might be expected to arise from the development;
- Determine if data is sufficient to make EIA judgments and, where relevant, HRA judgements with confidence;
- If further data is required, ensure that data gathered are targeted and directed at answering the key questions and filling key data gaps; and
- Review the information gathered to ensure the environment can be characterised in sufficient detail.

169. Consideration will also be given to the evolution of the baseline in the absence of the project; this will take account of current trends such as climate change and biodiversity loss.

170. The specific approach to establishing a robust baseline (upon which impacts can be assessed) is set out under each parameter within this Scoping Report (**Parts 2 to 4**). It is envisaged that this approach will be subject to review following the receipt of the Scoping Opinion from the Planning Inspectorate and subsequent consultation with statutory and non-statutory bodies. It is also recognised that this approach may evolve over time with the collection of new data from the study area and as the design of the project advances.

### 1.6.4 Assessment of Impacts

171. Potential impacts to be considered within the EIA will be agreed with stakeholders through an ongoing program of stakeholder engagement throughout the EIA process. The EPP will also inform the scope of the impact assessment for those environmental receptors covered by ETGs (namely Offshore Ornithology; Marine Mammal Ecology; Seabed (including benthic ecology, fish and shellfish ecology, and marine physical processes); Terrestrial Ecology and Ornithology; Seascape, Landscape and Visual; Traffic; and Archaeology (both onshore and offshore)).



172. The approach the EIA team will take to making balanced assessments will be guided by both EIA specialists and technical specialists using existing data, newly collected data, experience and expert judgement. In order to provide a consistent framework and system of common tools and terms, where appropriate, a matrix approach will be used to frame and present the professional judgements that are made. However, it should be noted that for each topic of the EIA, the latest guidance or best practice will be used and therefore definitions of sensitivity and magnitude of impact will be tailored to each receptor. The impact assessment will consider the potential for impacts during the construction, operation and decommissioning of DEP and SEP.

#### 1.6.4.1 Determining Receptor Sensitivity and Value

173. The determination of receptor sensitivity is required to assess the potential impacts upon each receptor.

174. Receptor value considers whether, for example, the receptor is rare, has protected or threatened status, importance at local, regional, national or international scale, and in the case of biological receptors whether the receptor has a key role in the ecosystem function. These considerations are balanced against the properties of the receptor under consideration.

175. The ability of a receptor to adapt to change, tolerate, and/or recover from potential impacts will be key in assessing its sensitivity to the impact under consideration. For ecological receptors tolerance could relate to short term changes in the physical environment, for human environment receptors tolerance could relate to displacement effects and therefore impacts upon economics or safety. It also follows that the capacity to recover will be a key consideration in determining receptor sensitivity.

176. The overall receptor sensitivity is determined by considering a combination of value, adaptability, tolerance and recoverability and applying expert judgement and / or past experience.

177. Expert judgement is particularly important when determining the sensitivity of receptors. For example, an Annex II species (under the Habitats Directive) would have a high value, but if it was highly tolerant of an impact or had high recoverability it would follow that the sensitivity in this instance should reflect the ecology rather than default to the protected status alone.

#### 1.6.4.2 Predicting the Magnitude of Impacts

178. To predict the significance of an impact, it is necessary to establish the magnitude and probability of an impact occurring through a consideration of:

- Scale or spatial extent (small scale to large scale or most of the population or a few individuals);
- Duration (short term to long term);
- Frequency; and
- Nature of change relative to the baseline.

### 1.6.4.3 Evaluation of Significance

179. After establishing the sensitivity and magnitude, the impact significance will be predicted using quantitative or qualitative criteria as appropriate to ensure a robust assessment. Where possible, a matrix such as the one presented in **Table 1-11** will be used to aid assessment of impact significance based on expert judgement. As stated earlier the matrix is used to aid transparency in the professional judgements that are made. For each section of the ES, the best methodology (based on the latest available guidance) will be followed and, when more appropriate, an approach other than the matrix may be used.



180. **Table 1-12** provides an indication of the significance definitions that the Applicant proposes to use in the assessment process for the majority of parameters. These will be confirmed through the EIA process.
181. A description of the approach to impact assessment and the interpretation of significance levels will be provided within each section of the ES. This approach will ensure that the definition of impacts is transparent and relevant to each topic under consideration.

*Table 1-11 Significance of an impact resulting from each combination of receptor sensitivity and the magnitude of the effect upon it.*

		Negative Magnitude				Beneficial Magnitude			
		High	Medium	Low	Negligible	Negligible	Low	Medium	High
Sensitivity	High	Major	Major	Moderate	Minor	Minor	Moderate	Major	Major
	Medium	Major	Moderate	Minor	Minor	Minor	Minor	Moderate	Major
	Low	Moderate	Minor	Minor	Negligible	Negligible	Minor	Minor	Moderate
	Negligible	Minor	Negligible	Negligible	Negligible	Negligible	Negligible	Negligible	Minor

Table 1-12 Impact significance definitions

Impact Significance	Definition
<b>Major adverse</b>	Very large or large change in receptor condition, both adverse or beneficial, which are likely to be important considerations at a regional or district level because they contribute to achieving national, regional or local objectives, or, could result in exceedance of statutory objectives and/or breaches of legislation.
<b>Moderate adverse</b>	Intermediate change in receptor condition, which are likely to be important considerations at a local level.
<b>Minor adverse</b>	Small change in receptor condition, which may be raised as local issues but are unlikely to be important in the decision-making process.
<b>Negligible</b>	No discernible change in receptor condition.
<b>Minor beneficial</b>	The impact is of minor significance but has been assessed as having some benefit to receptor condition.
<b>Moderate beneficial</b>	The impact is assessed as providing a moderate benefit to receptor condition.
<b>Major beneficial</b>	The impact is assessed as providing a significant benefit to receptor condition.

#### 1.6.4.4 Mitigation

182. Where the impact assessment identifies that an aspect of the development is likely to give rise to significant environmental impacts, mitigation measures will be proposed and discussed with the relevant authorities to avoid impacts or reduce them to acceptable levels and, if possible, to enhance the environment.
183. Additionally ‘biodiversity net gain’ will be sought through the mitigation hierarchy for onshore elements so that it can be demonstrated that the Projects are improving biodiversity, in line with new governmental mandate. So far net gain discussions have focussed on onshore project elements only, but these have recently been expanded to consider potential mechanisms in the intertidal zone as well. The Projects will follow these discussions and any new guidance in relation to intertidal and offshore net gain.
184. For the purposes of the EIA, two types of mitigation have been defined and these will be identified in the ES:
- Embedded mitigation, consisting of mitigation measures that are identified and adopted as part of the project design, will be included and assessed in the EIA; and
  - Additional mitigation, consisting of mitigation measures that are identified during the EIA process to reduce or eliminate any predicted impacts, which are subsequently adopted by the Applicant as project commitments.

#### 1.6.4.5 Assessing Residual Impacts

185. Following identification of mitigation measures, impacts will be re-assessed and all residual impacts will be described. Where no mitigation measure is proposed, an explanation will be provided as to why the impact cannot be reduced.

#### 1.6.4.6 Inter-relationships

186. The assessments will consider relevant inter-relationships, as indicated in Parts 2 to 4 below. The objective will be to identify instances where the accumulation of residual impacts on a single receptor, and the relationship between those impacts, might affect the requirement for mitigation.

#### 1.6.4.7 Cumulative Impacts

187. Cumulative Impact Assessment (CIA) forms part of the EIA process. The scope of the CIA (in terms of relevant issues and projects) will be established with consultees (including other developers) as the EIA progresses. In addition, the Applicant will look at the experience from other projects off the Norfolk and Suffolk coast, the wider Southern North Sea, and other UK projects as well as incorporating continuing work from industry-wide initiatives with regard to cumulative impact.
188. The Planning Inspectorate Advice Notes Nine and Seventeen provide guidance on plans and projects that should be considered in the CIA including:
- Projects that are under construction;
  - Permitted applications, not yet implemented;
  - Submitted applications not yet determined;
  - Projects on the Planning Inspectorate's Program of Projects;
  - Development identified in relevant Development Plans, with weight being given as they move closer to adoption and recognising that much information on any relevant proposals will be limited; and
  - Sites identified in other policy documents as development reasonably likely to come forward.
189. Only projects which are reasonably well described and sufficiently advanced to provide information on which to base a meaningful and robust assessment will be included in the CIA.
190. Projects which are sufficiently implemented during the site characterisation for DEP and SEP will be considered as part of the baseline for the EIA.
191. Offshore cumulative impacts may come from interactions with the following activities and industries:
- Other wind farms;
  - Aggregate extraction and dredging;
  - Licensed disposal sites;
  - Navigation and shipping;
  - Commercial fisheries;
  - Sub-sea cables and pipelines;

- Potential port/harbour development; and
- Oil and gas activities.

192. Onshore plans or projects that may be considered include (but not limited to):

- Other offshore wind farm infrastructure present onshore;
- Other energy generation infrastructure;
- Building/housing developments;
- Installation or upgrade of roads;
- Installation or upgrade of cables and pipelines;
- Coastal protection works; and
- National Grid works.

193. The full list of ongoing plans or projects to be included in the CIA will be developed as part of on-going consultation with technical consultees.

194. With respect to the consenting strategy as described in **Section 1.1.2** (namely a single application for development consent addressing both wind farm extensions and their associated transmission infrastructure), cumulative impacts will be considered in relation to both of the projects being developed together, as the worst case.

#### 1.6.4.8 Transboundary Effects

195. Regulation 24 of the EIA regulations sets out procedures to address issues associated with a development that might have significant impact on the environment in another European Member State.

196. The procedures involve providing information to the Member State and for the Planning Inspectorate to engage in consultation with that State regarding the significant impacts of the development and the associated mitigation measures. Further advice on transboundary issues, in particular with regard to consultation is given in the Planning Inspectorate Advice Note Twelve (Planning Inspectorate, 2015c).

#### 1.6.4.9 Assessment of Development Options

197. As described in **Section 1.1.2**, a combined EIA process will be followed for DEP and SEP, with combined associated submissions. Each project will be assessed individually, thereby covering the possibility that one or the other (but not both) of the projects are developed, as well as both projects being assessed together, either concurrently or sequentially. In the case that both projects are developed, the EIA will consider the appropriate realistic worst-case scenario with respect to the integrated or separate grid options (see **Section 1.1.2** for further details) and present the results accordingly.

198. Assessing the development options in this way will ensure a consistent and transparent approach to assessments, consultation and examination, and will facilitate comparison of the impacts associated with the different options alongside identification of the worst case option in terms of environmental impact.

#### 1.6.5 Draft Outline of the Environmental Statement

199. The ES will document the EIA process and will describe the project and the EIA process with regard to the latest legislation, policy and guidance. Subject to the outcomes of the scoping process, the ES may comprise the following documents, parts and chapters:

- 
- Volume 1 Non-Technical Summary
  - Volume 2 Environmental Statement
    - Part 1: Introductory Chapters
      - Introduction
      - Need for the Project
      - Policy and Legislative Context
      - Site Selection and Assessment of Alternatives
      - Site Description
      - Project Description
      - EIA methodology
    - Part 2: Offshore Environment
      - Marine Geology, Oceanography and Physical Processes
      - Marine Water and Sediment Quality
      - Benthic and Intertidal Ecology
      - Fish and Shellfish Ecology
      - Marine Mammal Ecology
      - Offshore Ornithology
      - Commercial Fisheries
      - Shipping and Navigation
      - Offshore Archaeology and Cultural Heritage
      - Aviation and MoD
      - Other Marine Users
      - Offshore Designated Sites Summary
    - Part 3: Onshore Environment
      - Onshore Ground Conditions and Contamination
      - Air Quality
      - Water Resources and Flood Risk
      - Land Use
      - Onshore Ecology (including onshore nature conservation designations)
      - Onshore Ornithology
      - Onshore Archaeology and Cultural Heritage
      - Noise and Vibration
      - Traffic and Transport

- Part 4: Wider Scheme Impacts
  - Landscape and Visual
  - Socio-Economics
  - Human Health
  - Tourism and Recreation
- Part 5: Cumulative and Transboundary Impacts
- Part 6: Summary of Impacts
- Volume 3: Technical appendices.

### 1.6.6 Other DCO Documents

200. The EIA work will inform and/or relate to a number of other documents, plans and strategies which will be included in the overall suite of application documents. The precise approach will be finalised as the application progresses but is likely to include:

- Environmental Protection Statement of Engagement.
- Report to Inform Habitats Regulations Assessment.
- Flood Risk assessment.
- Safety Zone Assessment.
- Navigation Risk Assessment.
- Schedule of Mitigation.
- Code of Construction Practice.
- Design and Access Statement.
- Outline Written Scheme of Investigation (onshore).
- Outline Written Scheme of Investigation (offshore).
- Public Rights of Way Strategy.
- Outline Landscape and Ecological Management Strategy.
- Draft Great Crested Newt Licence Application.
- Outline Traffic Management Plan.
- Outline Access Management Plan.
- Abnormal Loads assessment.
- Construction Environmental Management Plan.
- In Principle Monitoring Plan.
- Outline Offshore Operations and Maintenance Plan.
- Site Characterisation Report (in the case of dredging and disposal activities in the marine environment).
- Draft Marine Mammal Mitigation Protocol.
- In Principle Site Integrity Plan (in the case of potential impacts on the Southern North Sea Special Area of Conservation – to be determined).

## 2 PART 2: OFFSHORE

### 2.1 Marine Geology, Oceanography and Physical Processes

201. The specific assessment requirements for marine geology, oceanography and physical processes are set out within the overarching National Policy Statement (NPS) for Energy EN-1 and NPS for Renewable Energy Infrastructure (EN-3) and are summarised in **Table A1-1** in **Appendix 1**.

#### 2.1.1 Existing Environment

##### 2.1.1.1 Tidal Currents

202. Spring tide current flows across the DEP and SEP sites are directed approximately northwest on a flood tide and southeast on an ebb tide. Mean spring tide current velocities of about 1m/s occur at the sites with lower velocities closer to the coast across the export cable corridors. Closer to the coast, current directions are approximately shore-parallel. Tidal current residuals have variable directions and velocities from the coast across the extension sites.

##### 2.1.1.2 Wave Regime

203. The most frequent waves across the extension sites are from the southwest to northwest sector, but their fetch lengths are relatively short, and significant waves are small (generally less than 1m). Waves from the northwest to northeast sector are less frequent, but they are not fetch-limited and generate larger waves. Nearshore wave conditions are less severe due to the protection afforded by Sheringham Shoal sand bank.

##### 2.1.1.3 Bedload Sediment and Transport

204. Apart from Sheringham Shoal sand bank, sea bed sediment comprises a thin veneer (generally less than 0.5m but up to 1-2m in places) of gravelly sand resting on till. Chalk may be exposed at the sea bed closer to the coast. The sand comprising Sheringham Shoal is up to 10m thick and surrounded by sand waves up to 5m high. Over most of the regional area the dominant driver of sediment transport is tidal current flow, and so the net sediment transport directions and rates are reflected in the variable tidal current residuals.

205. The coast of north to northeast Norfolk at the landfall search areas is an almost continuous line of glacial till cliffs with a short length of chalk cliffs at Weybourne. The coast is exposed and dynamic with rapid cliff erosion occurring in places. Severe storm events can rapidly change beach levels and the degree of exposure of the natural or defended coastline. Net sediment transport is to the west at the Weybourne landfall search areas and to the southeast at the Bacton landfall search area.



#### 2.1.1.4 Suspended Sediment

206. Typical mean summer suspended sediment concentrations along the export cable routes and at the extension sites are less than 10mg/l whereas mean winter concentrations are 30mg/l, although concentrations may increase significantly during storm events. These moderate ambient concentrations mean that the transient impact of sediment plumes arising from installation of the wind farm may be significant (although temporally limited) under specific circumstances.

#### 2.1.2 Potential Impacts

207. The Marine Geology, Oceanography and Physical Processes assessment is likely to have key inter-relationships with Marine Water and Sediment Quality, Benthic and Intertidal Ecology and Fish and Shellfish Ecology and these will be considered where relevant throughout the EIA process.

##### 2.1.2.1 Potential Impacts During Construction

###### *Effects to hydrodynamic regime (waves and tidal currents)*

208. Whilst there is potential for the physical presence of construction plant and offshore infrastructure to impact upon the hydrodynamic regime, this impact would increase incrementally as the wind farm extensions are constructed with the greatest potential impacts resulting from the completed wind farms. This impact is therefore covered under 'Potential impacts during operation', below, and is scoped out of further consideration in relation to the construction phase.

###### *Effects on bedload sediment transport*

209. Construction of the wind farm extensions will not change the geology of the site other than in the case of localised effects associated with foundation and cable installation. Due to the localised nature of these effects it is not anticipated that such changes would give rise to significant impacts on sea bed features, and neither would there be any changes in coastal morphology. However, further consideration (using conceptual methods) will be given to the potential effects on the form and function of the bedload sediment transport processes due to cable installation.

###### *Effects on suspended sediment concentrations and transport*

210. Sea bed preparation (for foundation and cable laying), drilling for foundations, and cable installation (including ploughing/trenching and burial, open cut and HDD) would lead to localised sediment disturbance and temporary increases in suspended sediment concentrations. The effect of construction activities on suspended sediment concentrations will be assessed using expert based assessment, predicated on a source-pathway-receptor conceptual model and verified and tested against previous numerical modelling for the existing Dudgeon and Sheringham Shoal Offshore Wind Farms.

### 2.1.2.2 Potential Impacts During Operation

#### *Effects to hydrodynamic regime (waves and tidal currents)*

211. Multiple large foundations and any persistent drill arising mounds are likely to increase local drag forces and tidal flows and potentially diffract and scatter waves which could lead to morphological and physical compositional changes to the sea bed. The potential for operational effects on waves and tidal currents will be assessed in the same conceptual way as construction effects on suspended sediment concentrations and transport.

#### *Effects on bedload sediment transport*

212. Previous studies have concluded that minimal impacts can be expected on the prevailing bedload sediment transport conditions, both within wind farm sites as well as in the far-field, provided that the foundations are adequately spaced (which will vary depending on the details of the foundations and wind farm layout). Impacts on sediment transport are likely to be localised to the areas immediately surrounding the individual foundations in the form of sea bed scour where the sediment is soft enough to be mobilised. Scour at each foundation will be assessed using well-established empirical methods applied to offshore wind farms elsewhere.

213. Where the export cables are buried there would be no effect on bedload sediments and sediment transport. However, it is possible that cable protection would be required at locations where the sea bed is characterised by hard geology and at the landfall exit points. The effects that cable protection may have on marine geology, oceanography and physical processes primarily relate to the potential for interruption of sediment transport, both offshore and at the coast, and the footprint they present on the sea bed. The effect of cable operation on sediment transport will be assessed using conceptual methods and expert based judgement.

#### *Effects on suspended sediment concentrations and transport*

214. There is potential for sediments to be re-suspended by scouring effects. Consideration will be given (using conceptual methods) to likely changes in suspended sediment concentrations due to scour during the operational phase.

### 2.1.2.3 Potential Impacts During Decommissioning

215. The removal of the foundations has the potential to affect hydrodynamic regime, sediments and sedimentary structures, and suspended sediment concentrations and transport. Any impacts arising from decommissioning are likely to be of lower magnitude than those associated with construction.

### 2.1.2.4 Potential Cumulative Impacts

216. There is the potential for cumulative impacts with a range of other activities including the existing wind farms, aggregate extraction and dredging, subsea cables and oil and gas activity. These will be identified and assessed in line with the approach set out in **Section 1**.

### 2.1.2.5 Potential Transboundary Impacts

217. Given that the likely hydrodynamic and sedimentary impacts of the extensions will be restricted to near-field change only, transboundary impacts are unlikely to occur, or are unlikely to be significant, and therefore it is proposed that transboundary impacts will not be considered further during the EIA for this topic.

### 2.1.2.6 Summary of Potential Impacts

218. A summary of potential impacts is shown in **Table 2-1**.

*Table 2-1 Summary of impacts relating to marine geology, oceanography and physical processes (scoped in ✓, scoped out x)*

Potential Impacts	Construction	Operation	Decommissioning
Effects on hydrodynamic regime (waves and tidal currents)	x	✓	✓
Effects on bedload sediment transport	✓	✓	✓
Effects on suspended sediment concentrations and transport	✓	✓	✓
Cumulative impacts	✓	✓	✓
Transboundary impacts	x	x	x

### 2.1.3 Approach to Assessment and Data Gathering

219. As part of the EIA process, the existing environment with respect to marine geology, oceanography and physical processes will be described, including, but not limited to the following:

- Bathymetry;
- Geology;
- Water levels;
- Tidal currents;
- Waves;
- Climate change;
- Sea bed sediment distribution;
- Bedload sediment transport;
- Suspended sediment transport;
- Morphological change;
- Coastal processes at the landfall; and
- Anticipated trends in baseline conditions.

220. For the effects on marine geology, oceanography and physical processes, the assessment will follow two approaches. The first type of assessment is impacts directly affecting receptors which possess their own intrinsic morphological value. The impact assessment will incorporate a combination of the sensitivity of the receptor, its value (if applicable) and the magnitude of the change to determine a significance of impact.

221. In addition to identifiable receptors, the second type of assessment would cover changes to marine geology, oceanography and physical processes which in themselves are not necessarily impacts to which significance can be ascribed (such as an increase in suspended sediment concentrations). However, such changes may indirectly impact other receptors such as benthic and intertidal ecology (for example). In this case, the magnitude of effect is determined in a similar manner to the first assessment method but the significance of impacts on other receptors is made within the relevant chapters of the ES pertaining to those receptors.

222. **Table 2-2** identifies the main desk-based sources that will be accessed to inform the characterisation of the existing environment.

*Table 2-2 Data sources that will be used*

Data source	Date	Data contents
Scira Sheringham Shoal Offshore Wind Farm Environmental Statement and associated technical supporting documents	2006	All marine geology, oceanography and physical processes information and data related to the existing offshore wind farm
HR Wallingford. 2006. Sheringham Shoal Wind farm: Coastal and seabed processes. HRW Report EX5117.	2006	Numerical modelling of the existing offshore wind farm
Dudgeon Offshore Wind Farm Environmental Statement and associated technical supporting documents	2009	All marine geology, oceanography and physical processes information and data, including numerical modelling, related to the existing wind farm
Geophysical monitoring of Dudgeon Offshore Wind Farm (Fugro EMU)	2014	Bathymetry, bedforms, sea bed sediment distribution, shallow geology
Post construction geophysical monitoring of Sheringham Shoal Offshore Wind Farm (Fugro EMU)	2014-15	Bathymetry and sea bed character
Post construction geophysical monitoring of Dudgeon Offshore Wind Farm (MMT)	2018	Bathymetry and sea bed character
Post construction environmental monitoring of Dudgeon Offshore Wind Farm (MMT)	2018	Sea bed sediments

223. The following surveys / studies will be undertaken in 2019-2020 to inform the assessment (**Table 2-3**). Surveys will be agreed in advance with stakeholders where required.

*Table 2-3 Proposed baseline surveys*

Survey/study	Timing	Spatial Coverage
Multibeam bathymetry	2019-2020	Extension areas and offshore cable corridor

Survey/study	Timing	Spatial Coverage
Side-scan sonar	2019-2020	Extension areas and offshore cable corridor
Sub-bottom profiling	2019-2020	Extension areas and offshore cable corridor

224. The assessment will be undertaken in accordance with following standards and guidance:

- Guidance on Environmental Impact Assessment in Relation to Dredging Applications (Office of the Deputy Prime Minister, 2001);
- Offshore Wind Farms: Guidance Note for Environmental Impact Assessment in respect of Food and Environmental Protection Act (FEPA) and Coast Protection Act (CPA) requirements: Version 2 (Cefas, 2004);
- Review of Cabling Techniques and Environmental Effects applicable to the Offshore Windfarm Industry (BERR, 2008);
- Coastal Process Modelling for Offshore Windfarm Environmental Impact Assessment (COWRIE, 2009); and
- Guidelines for Data Acquisition to support Marine Environmental Assessments of Offshore Renewable Energy Projects (Cefas, 2011).

225. The assessment of effects on marine geology, oceanography and physical processes will be predicated on a source-pathway-receptor conceptual model, whereby the source is the initiator event, the pathway is the link between the source and the receptor impacted by the effect, and the receptor is the receiving entity. An example of this type of conceptual model is provided by cable installation which disturbs sediment on the seabed (source). This sediment is then transported by tidal currents until it settles back to the seabed (pathway). The deposited sediment could change the composition and elevation of the seabed (receptor).

226. Following the identification of the preferred offshore development area, further liaison with stakeholders will be undertaken to agree the approach and methodology to data collection for EIA purposes and the specific assessment methodology. A detailed method statement will be developed and agreed with stakeholders as part of the EPP.

## 2.2 Marine Water and Sediment Quality

227. The specific assessment requirements for Marine Water and Sediment Quality are set out within National Policy Statements EN-1 and EN-3 and are summarised in **Table A1-2** in **Appendix 1**.

### 2.2.1 Existing Environment

#### 2.2.1.1 Sediment Information

228. The existing Dudgeon and Sheringham Shoal Offshore Wind Farms have carried out numerous site specific surveys in and around the DEP and SEP sites at the characterisation (EIA), pre-construction and post-construction stages of development (e.g. DOW, 2009; Scira, 2014, 2006; Fugro, 2015; Equinor, 2019). Due to their close proximity these provide a good indication of the general nature of the sediments that can be expected in the proposed extension sites, interlink and export cable corridors.

229. Post-construction surveys within and around the existing Dudgeon Offshore Wind Farm array and export cable corridor (Equinor, 2019) recorded sediment mainly comprised of sand and gravel. The proportion of mud (clay and silt) recorded was very low (maximum 7%) in all but one sample, which had a mud content of 24%. Similarly, the Sheringham Shoal Offshore Wind Farm Environmental Statement (Scira, 2006) identifies coarse to medium sands, gravels and pebbles as the main sediment types recorded across the site. A Sheringham Shoal Offshore Wind Farm post-construction benthic monitoring survey (Scira, 2014) confirmed deposits were predominantly characterised by sand and gravel with lower proportions of silt. Eight sample stations taken from a reference area, located within the proposed SEP site, recorded sediments dominated by sand and gravel components.
230. In terms of sediment quality, the results from sediment analysis undertaken to inform the Dudgeon Offshore Wind Farm Environmental Statement (DOW, 2009) indicate low levels of contamination across both the offshore wind farm and export cable corridor (i.e. below Cefas Action Level 1). At Sheringham Shoal Offshore Wind Farm, samples from five locations were analysed within and around the proposed cable corridor (Scira, 2006). Samples were only taken in the nearshore environment, as it was agreed that the potential for historical contamination in the wind farm area was limited, given the prevailing sedimentary and hydrodynamic regime and the lack of fine material to which contaminants could bind. Only one site exceeded Cefas Action Level 1, for arsenic, but the exceedance was marginal (i.e. only just above Action Level 1). Elevated levels of arsenic are typical of this region of the southern North Sea and are associated with estuarine and geological inputs from seabed rock weathering.

### 2.2.1.2 Water Quality

231. Information collated in the Environmental Statement for Sheringham Shoal notes that suspended solids loads vary from typical mean summer values of less than 10mg/l to typical mean winter values of 30mg/l. During storm events, the natural levels of suspended solids may increase well above these values (see [Section 2.1](#)) (Scira, 2006).
232. Information is available from Defra to assess progress against the UK Government and the Devolved Administration's vision of clean, healthy, safe, productive and biologically diverse oceans and seas. Charting Progress 2 (2014) states that, for the North Sea, toxicological hazard from metals in water samples analysed against EU Directive requirements (mainly in estuarine waters) and Shellfish Waters (mainly in coastal waters); nearly 99% of metal concentrations were below the UK Environmental Quality Standards (EQS) values in 2007, although 6% of copper concentrations exceeded the EQS. However, areas where these exceedances were recorded were located within estuarine environments, not in offshore waters. As a result, the report concludes that levels of contaminants in offshore UK waters are generally low.



233. The offshore cable route search areas run through Water Framework Directive (WFD) coastal water bodies, specifically the Norfolk East WFD coastal water body (GB650503520000), and the Weybourne corridor option is partly located within the Norfolk North WFD water body (GB640503300000) in the western part of the landfall approach (see **Figure 2.2.1, Appendix 2**). Both water bodies are ‘heavily modified’; Norfolk North due to flood protection and Norfolk East due to flood and coastal protection. Both water bodies are currently classified to have an overall status of ‘moderate’ (Environment Agency, 2019a).
234. Classification for physico-chemical parameters in both water bodies is considered moderate due to dissolved inorganic nitrogen concentrations in the water. In the River Basin Management Plan, reasons for the elevated inorganic nitrogen concentrations are listed as diffuse pollution (arable land and therefore field runoff), and point sources associated with sewage discharges. In terms of chemical contaminants, both water bodies are considered to be at ‘good’ status, thus indicating no exceedances of EQS.
235. There are five designated bathing waters located within the vicinity of the offshore cable route search area (see **Figure 2.2.1, Appendix 2**). The WFD bathing waters in closest proximity to the landfall areas are Sheringham, and Mundesley. These bathing waters have been classified as having excellent bathing water quality since 2016 (Environment Agency, 2019b).

## 2.2.2 Potential Impacts

236. The Marine Water and Sediment Quality assessment is likely to have key inter-relationships with Marine Physical Processes, Benthic and Intertidal Ecology and Fish and Shellfish Ecology and these will be considered where relevant throughout the EIA process.

### 2.2.2.1 Potential Impacts During Construction

237. Potential effects during construction primarily relate to the potential for releasing sediment into the water column during either seabed preparation, drilling for foundations or during cable installation. This in turn could give rise to changes in water quality with increases in suspended solid concentrations and releases of any contamination associated with sediment particles.
238. Effects could also occur if construction vessels and equipment discharge, leak or spill contaminants into the water. However, all vessels involved will be required to comply with the International Convention for the Prevention of pollution from Ships (MARPOL) 73/78. A Project Environmental Management and Monitoring Plan (or similar) will also be put in place to ensure all works are undertaken in line with best practice for working in the marine environment. As a result, it is proposed that effects relating to leaks or spills are scoped out of the EIA.



### 2.2.2.2 Potential Impacts During Operation

239. Localised changes in tidal and wave regimes around each foundation structure could have the potential to result in scour of the seabed and therefore increase concentrations of suspended sediments in the water column. However, these are likely to be localised to the structures and short lived (i.e. only during storm conditions). Consequently, if it is present, sediment contamination is also unlikely to give rise to changes in marine water quality. As a result, it is proposed that these effects are scoped out from further consideration within the EIA.
240. As per the construction phase, there is also the potential for spillages during maintenance operations, however, best practice measures will be put in place during the operation phase to reduce the risk as far as possible. As a result, it is proposed that effects from spills and leaks during operation are scoped out of the EIA.

### 2.2.2.3 Potential Impacts During Decommissioning

241. It is anticipated that the decommissioning impacts would be similar in nature to those of construction, although the magnitude of effect is likely to be lower. The effects will therefore be considered in the EIA although detailed assessment will be undertaken at the time of decommissioning using the latest available information.

### 2.2.2.4 Potential Cumulative Impacts

242. There is the potential for cumulative impacts with a range of other plans, projects and activities namely the existing Dudgeon and Sheringham Shoal offshore wind farms, other nearby offshore wind farms at planning, construction, operation and decommissioning phases, aggregate and dredging activities, oil and gas activity and subsea cable installation. These will be identified and assessed in line with the approach set out in **Section 1**.

### 2.2.2.5 Potential Transboundary Impacts

243. As the effects on Marine Water and Sediment Quality are likely to be restricted to the project boundary and immediate surrounding area, transboundary effects are proposed to be scoped out of the assessment.

### 2.2.2.6 Summary of Potential Impacts

244. A summary of potential impacts is shown in **Table 2-4** below.

*Table 2-4 Summary of impacts relating to marine sediment and water quality (scoped in ✓, scoped out x)*

Potential Impacts	Construction	Operation	Decommissioning
Potential for increases in suspended sediment	✓	x	✓
Potential for the release of contamination	✓	x	✓
Potential for accidental spills and leaks	x	x	x

Potential Impacts	Construction	Operation	Decommissioning
Cumulative impacts	✓	✓	✓
Transboundary impacts	x	x	x

### 2.2.3 Approach to Assessment and Data Gathering

245. As part of the EIA process, the existing environment with respect to Marine Water and Sediment Quality will be described, including, but not limited to the following:

- Seabed sediment type;
- Sediment contaminant levels;
- Water Quality (physico-chemical and chemistry); and
- Designations (bathing waters and WFD water bodies).

246. **Table 2-5** identifies the desk-based sources that will be accessed to inform the characterisation of the existing environment.

*Table 2-5 Data sources to be used*

Data source	Date	Data contents
DOW	2009	Dudgeon OWF Environmental Statement.
Scira	2006	Sheringham Shoal OWF Environmental Statement.
Equinor	2018/2019	Dudgeon OWF post-construction survey reporting.
Scira	2014	Sheringham Shoal Offshore Wind Farm. Second Post-Construction Benthic Monitoring Survey.
Environment Agency Data Catchment Explorer	2019b	Database for information related to river basin management plans (RBMP) in England. Contains information on river basin districts and catchments and Water Framework Directive compliance data.
Bathing water profiles	2019a (updated annually)	Water quality at designated bathing water sites in England are assessed by the Environment Agency between May and September. Data is published by the Environment Agency online.
Information in Marine Geology, Oceanography and Physical Processes chapter	2020	This chapter will provide baseline information on sediment type, suspended solids concentrations and potential concentrations of sediments within any plumes created during construction.

247. The following survey will be undertaken to inform the assessment (**Table 2-6**). The survey methods and required analyses will be agreed in advance with stakeholders including the MMO, Cefas and Natural England. As set out in **Section 2.1**, the effect of construction activities on suspended sediment concentrations will be assessed using expert based assessment using a source-pathway-receptor conceptual model. This model would be verified and tested against previous numerical modelling for the existing Dudgeon and Sheringham Shoal Offshore Wind Farms. The results will be used to inform the assessment of effects on Marine Sediment and Water Quality.

*Table 2-6 Proposed baseline surveys*

Survey/study	Timing	Spatial Coverage
Grab samples (as part of the Benthic Ecology survey, see <b>Section 2.3</b> )	Early – mid 2020	Wind farm area and export cable corridors

248. The assessment will be undertaken in accordance with following standards and guidance:

- Cefas Action Levels (available at MMO, 2014) to assess the risk to water quality associated with sediment contamination. Where high levels of contamination are identified (i.e. close to or above Cefas Action Level 2), consideration against WFD EQS will be undertaken.

249. The assessment will follow the methodology as outlined in **Section 1.6** with topic specific definitions for sensitivity and magnitude.

250. Following the identification of the preferred offshore development area, further consultation with the relevant stakeholders will be undertaken to agree the approach and methodology to data collection for EIA purposes and the specific assessment methodology. A detailed method statement will be developed and agreed with stakeholders as part of the EPP.

## 2.3 Benthic and Intertidal Ecology

251. The specific assessment requirements for Benthic and Intertidal Ecology are set out within National Policy Statements EN-1 and EN-3 and are summarised in **Table A1-3** in **Appendix 1**.

### 2.3.1 Existing Environment

252. The existing Dudgeon and Sheringham Shoal Offshore Wind Farms have carried out numerous site specific surveys in and around the development sites at the characterisation (EIA), pre-construction and post-construction stages of development (e.g. DOW, 2009; Scira, 2006, 2014; Fugro, 2015; Equinor, 2019). Due to their close proximity these provide a good indication of the general nature of the benthic and intertidal ecology that can be expected in the proposed extension areas, interlink and export cable corridors.

### 2.3.1.1 Subtidal habitats

253. The EUNIS habitats present within the scoping area are predominantly coarse sediment, with patches of rock, fine sand and muddy sand (**Figure 2.3.1** in **Appendix 2**; EMODnet, 2019). Seabed sediments in the area are dominated by sand, gravel and cobbles with smaller areas of mud and silt and the potential for outcropping chalk in the nearshore (Scira, 2006, 2014; DOW, 2006; Fugro, 2015; Equinor, 2019).

### 2.3.1.2 Subtidal species

254. The biotopes recorded at both of the existing Dudgeon and Sheringham Shoal Offshore Wind Farm sites and export cable routes including those with protected features are described below (**Table 2-7**).

**Table 2-7** Biotopes and biotope complexes recorded during the site-specific surveys.

Site	Biotope or biotope complex	Designation (MarLIN, 2019)
Sheringham Shoal (Scira, 2006)	SS.SBR.PoR.SspiMx - Sparse or moderately dense crusts of <i>S. spinulosa</i> on circalittoral mixed sediment	Listed under the EC Habitats Directive for the Annex 1 feature Reef, OSPAR Annex V, Habitat of Principal Importance, Habitat of Conservation Interest
	SS.SCS.ICS - Infralittoral coarse sand	None
Dudgeon (Fugro, 2015; Equinor, 2019)	CR.HCR.XFa.FluCoAs.SmAs - <i>Flustra foliacea</i> , small solitary and colonial ascidians on tide-swept circalittoral bedrock or boulders	None
	SS.SSA.IFiSa.NcirBat - <i>Nephtys cirrosa</i> and <i>Bathyporeia spp.</i> in infralittoral sand	Habitat of Principal Importance, Habitat of Conservation Interest
	SS.SMx.CMx.FluHyd - <i>Flustra foliacea</i> and <i>Hydrallmania falcata</i> on tide-swept circalittoral mixed sediment/ SS.SMx.IMx.CreAsAn - <i>Crepidula fornicata</i> with ascidians and anemones on infralittoral coarse mixed sediment	None
	CR.HCR.XFa.FluCoAs.SmAS - <i>Flustra foliacea</i> , small solitary and colonial ascidians on tide swept circalittoral bedrock and boulders	Listed under the EC Habitats Directive for the Annex 1 feature Reef
	SS.SCS.ICS.SLan - Dense <i>Lanice conchilega</i> and other polychaetes in tide-swept infralittoral sand and	SS.SCS.ICS.SLan - Habitat of Principal

Site	Biotope or biotope complex	Designation (MarLIN, 2019)
	mixed gravelly sand/ CR.MCR.CSab.Sspi – <i>Sabellaria spinulosa</i> encrusted circalittoral rock	Importance, Habitat of Conservation Interest
	SS.SCS.ICS.SLan - Dense <i>Lanice conchilega</i> and other polychaetes in tide-swept infralittoral sand and mixed gravelly sand/ CR.HCR.XFa.Mol – <i>Molgula manhattensis</i> with a hydroid and bryozoan turf on tide-swept moderately wave-exposed circalittoral rock	CR.HCR.XFa.Mol - Listed under the EC Habitats Directive for the Annex 1 feature Reef

255. Sand eels *Ammodytes sp.* are important prey species and are occasionally observed in association with SS.SSA.IFiSa.NcirBat (JNCC, 2015; MarLIN, 2019b). This biotope occurs throughout the existing Dudgeon Offshore Wind Farm site where the seabed was found to be comprised of medium to coarse sands (Equinor, 2019). *Ammodytes tobianus* were recorded in both pre- and post-construction surveys of the existing Dudgeon wind farm site (Fugro, 2015; Equinor, 2019). During the post-construction survey *A. tobianus* at a density of 1 per 0.1m<sup>2</sup> were recorded in a total of three samples within and just outside of the existing Dudgeon array (Equinor, 2019).
256. SS.SMx.IMx.CreAsAn is characterised by the presence of the invasive slipper limpet *Crepidula fornicata*. Post-construction surveys have noted an increase in the presence of slipper limpet within the existing Dudgeon and Sheringham Shoal arrays and export cable corridors (Equinor, 2019; Scira, 2014), however this is considered to be reflective of a regional increase in the presence and abundance of this species. The overall conclusion of the Dudgeon post-construction monitoring is that there are no significant differences in the benthic communities due to the construction of the wind farm (Equinor, 2019).
257. *Sabellaria spinulosa* is listed under Annex I of the Habitats Directive, and is a Habitat of Principal Importance when the density and elevation of the worm tubes meet certain criteria (Gubbay, 2007). Although non-Annex I reef *S.spinulosa* has been recorded at both of the existing sites, no Annex I *S.spinulosa* reefs have been recorded in the numerous surveys that have been undertaken over a long time period (Scira, 2006, 2014; Fugro, 2015; Equinor, 2019).
258. Similarly, biotopes CR.HCR.XFa.FluCoAs.SmAS and CR.HCR.XFa.Mol can also be listed under Annex I of the Habitats Directive for reefs if certain criteria are met (Irving, 2009). At the existing Dudgeon array and export cable corridor there was no evidence of reef-like structures in CR.HCR.XFa.FluCoAs.SmAS during the pre-construction survey (Fugro, 2015). This biotope was not present in the post-construction survey of the existing Dudgeon array and export cable corridor. CR.HCR.XFa.Mol was present as part of a mosaic on underlying chalk where *C.fornicata* was absent (Equinor, 2019). No reef-like structures were recorded by Sheringham Shoal post-construction benthic monitoring (Scira, 2014).

### 2.3.1.3 Intertidal habitats

259. The intertidal environment surveyed for both Sheringham Shoal and Dudgeon offshore wind farms was described as a highly mobile shingle beach, which was not deemed a suitable habitat for species colonisation and therefore detailed intertidal surveys were not carried out (DOW, 2012; Scira, 2006).
260. The intertidal environments at the landfall search areas are slightly different. At Weybourne (the landfall for the existing Dudgeon and Sheringham Shoal wind farms), the intertidal is predominantly comprised of moderate energy infralittoral seabed, moderate energy shallow circalittoral seabed, moderate energy infralittoral coarse sediment and littoral mud (Cefas, 2014; EMODnet, 2019). At Bacton, habitats include low and moderate energy infralittoral coarse sediment, littoral sand and muddy sand (JNCC, 2014; EMODnet, 2019).

### 2.3.1.4 Designated Sites and Protected Species and Habitats

#### *Protected Species and Habitats*

261. A number of protected species and habitats have been recorded in the offshore scoping area (**Table 2-7**). These include Habitats of Principal Importance and Habitats of Conservation Interest which are priority habitats and species within the UK listed under the Natural Environment and Rural Communities (NERC) Act (2006) Section 41. Biotopes that could be designated for bedrock, stony or biogenic reefs are also present which are described above.
262. Other protected species and habitats that could be present within the offshore scoping area are described in the following sections. The presence of protected species and habitats within the offshore scoping area will be further investigated during the site specific surveys described in **Table 2-10**.

#### *Designated Sites*

263. The proposed extension projects overlap with or are nearby a number of designated sites of relevance to benthic and intertidal ecology which are described below.

#### *Cromer Shoal Chalk Beds MCZ*

264. The Cromer Shoal Chalk Beds MCZ begins 200m from the North Norfolk Coast and extends 10km out to sea covering a total area of 321km<sup>2</sup> (DEFRA, 2016). The site is designated for features including exposed chalk and peat, which are rare in the North Sea. The chalk beds provide surfaces on which sessile organisms and algae can grow, in turn providing a habitat and nursery area for juvenile species. The chalk beds also provide a habitat for lobsters and crabs which support the local fishing industry (DEFRA, 2016).
265. Both of the export cable route search areas pass through the MCZ. The designated features that may be present within both of the export cable route search areas are:
- Moderate energy infralittoral and circalittoral rock;
  - Subtidal chalk;
  - Subtidal coarse sediment;
  - Subtidal mixed sediments; and
  - Subtidal sand.



### *The Wash and North Norfolk Coast SAC*

266. The Wash and North Norfolk Coast SAC covers an area of 1,077.18km<sup>2</sup> within The Wash Estuary and south along the Norfolk Coast. It was ensured through the site selection process that the cable route search areas would not pass through the SAC. At the closest point, the scoping boundary is 1.33km from the site. The features of the SAC present close to the scoping boundary include sandbanks which are slightly covered by seawater all the time (1110) and mudflats and sandflats not covered by seawater at low tide (1140).
267. There is an area of mudflats and sandflats not covered by seawater at low tide which extends outside of the SAC into the offshore cable route search area in the Weybourne landfall search area (JNCC, 2014). Both of the offshore cable route search areas are situated in an area with high potential for Annex I habitat 1110 Sandbanks (JNCC, 2016). Impacts on these habitats will be investigated through the EIA process using the results of the site-specific surveys.

### *The Greater Wash SPA*

268. The Greater Wash SPA stretches between the counties of Yorkshire to Suffolk over an area of 3,536km<sup>2</sup>. The site is primarily designated for the protection of seabirds (red throated diver (*Gavia stellata*), common scoter (*Melanitta nigra*), little gull (*Hydrocoloeus minutus*), Sandwich tern (*Sterna sandvicensis*), common tern (*Sterna hirundo*) and little tern (*Sternula albifrons*). However supporting features include marine habitats and species which could be present within the scoping area including subtidal sandbanks and biogenic reef including *Sabellaria* reefs and mussel beds.

## 2.3.2 Potential Impacts

269. The Benthic and Intertidal Ecology assessment is likely to have key inter-relationships with Marine Physical Processes, Marine Water and Sediment Quality, Fish and Shellfish Ecology and Offshore Ornithology and these will be considered where relevant throughout the EIA process.

### 2.3.2.1 Potential Impacts During Construction

270. Activities that disturb the seabed, namely installation of foundations and cables, may result in habitat loss and increased suspended sediments. Remobilisation of suspended sediments may also result in the release of contaminants into the water column, although the risk of this is considered very low as data suggests the absence of significant levels of contaminants in the area (DOW, 2009; Scira, 2006) (see [Section 2.2](#)). Introduction of artificial hard substrates and the use of vessels during the construction phase could encourage the influx of invasive species (the effect of which is assessed during operation).
271. Underwater noise and particle motion from piling may also lead to disturbance. Whilst this is not considered likely to cause significant impacts on benthic and intertidal ecology receptors in EIA terms, the latest research will be considered and presented within the ES.



272. The scoping area for the export cable corridors is located within the Cromer Shoal Chalk Beds MCZ. Cable burial and any rock protection could have an adverse impact on the sensitive features that the site is designated for, as described above. Impacts could occur through disturbance of the seabed, changes in suspended solids, habitat structure changes, changes in water flow, smothering and siltation rate changes and abrasion or disturbance of the substrate on the surface of the seabed.

### 2.3.2.2 Potential Impacts During Operation

273. Potential impacts during operation will result from the physical presence of infrastructure such as foundations and any cable protection which will result in a change in seabed substratum and permanent (project lifetime) habitat loss.

274. Maintenance activities may also result in temporary impacts, similar to those observed during construction but lower in magnitude. There may also be beneficial impacts such as habitat creation, which will also be considered in the EIA.

275. Noise and vibration generated by the operational wind turbines can be conducted through the tower and foundations into the water. Monitoring studies of underwater noise from operational turbines have shown the noise levels from North Hoyle, Scroby Sands, Kentish Flats and Barrow wind farms to be only marginally above ambient noise levels (Cheesman, 2016). There is no evidence to suggest this low level of noise and vibration has a significant impact on benthic ecology, it is therefore proposed that this impact is scoped out from further consideration within the EIA.

276. Electromagnetic fields (EMF) as a result of the presence of offshore cables may be detected by some benthic species. Effects are likely to be highly localised, as EMFs are strongly attenuated and decrease as an inverse square of distance from the cable (Gill and Barlett, 2010). Bochert & Zettler (2006) report that brown shrimp *Crangon crangon*, common starfish *Asterias rubens* and polychaete worm *Nereis diversicolor* (also known as *Hediste diversicolor*) do not react when exposed to EMF. Gibb *et al.* (2014) state there is no evidence of EMF impacting *Sabellaria spinulosa*. It is therefore proposed that this impact should be scoped out from further consideration within the EIA due to the lack of evidence to suggest an impact. The impacts of EMF on fish and shellfish are considered separately in [Section 2.7](#).

### 2.3.2.3 Potential Impacts During Decommissioning

277. It is anticipated that the decommissioning impacts would be similar in nature to those of construction described in [Section 2.3.2.1](#), although the magnitude of effect is likely to be lower.

### 2.3.2.4 Potential Cumulative Impacts

278. There is the potential for cumulative impacts with a range of other plans, projects and activities namely the existing Dudgeon and Sheringham Shoal Offshore Wind Farms, other nearby offshore wind farms at planning, construction, operation and decommissioning phases, aggregate and dredging activities, subsea cables and oil and gas activity. These will be identified and assessed in line with the approach set out in [Section 1](#).

### 2.3.2.5 Potential Transboundary Impacts

279. DEP and SEP are a minimum of 100km from any international territory boundary. As the effects on benthic and intertidal ecology are likely to be restricted to the project boundaries and immediate surrounding area, transboundary effects are proposed to be scoped out for this topic.

### 2.3.2.6 Summary of Potential Impacts

280. A summary of potential impacts is shown in **Table 2-8** below.

*Table 2-8 Summary of impacts relating to intertidal and benthic ecology (scoped in ✓, scoped out x)*

Potential Impacts	Construction	Operation	Decommissioning
Temporary physical disturbance	✓	✓	✓
Permanent habitat loss	x	✓	✓
Increased suspended sediment concentrations	✓	✓	✓
Re-mobilisation of contaminated sediments	✓	x	✓
Underwater noise and vibration	✓	x	✓
Colonisation of foundations and cable protection	x	✓	x
Invasive species	x	✓	x
Potential impacts on sites of marine conservation importance	✓	✓	✓
Impact of electromagnetic fields	x	x	x
Cumulative impacts	✓	✓	✓
Transboundary impacts	x	x	x

### 2.3.3 Approach to Assessment and Data Gathering

281. As part of the EIA process, the existing environment with respect to Marine and Intertidal Ecology will be described, including the presence of different habitats and species within the study area using existing survey data and data from new characterisation surveys that will be commissioned to inform the EIA.

282. Identification of potential sensitive receptors will be undertaken using available literature and the Marine Evidence Based Sensitivity Assessment (MarESA) method to determine sensitivity of benthic species and habitats (biotopes) using data from the Marine Life Information Network (MarLIN). This approach measures sensitivity of biotopes using available research on their resistance and resilience to different impacts.

283. As far as possible, impacts will be considered based on quantitative assessment of the area of habitat permanently or temporarily impacted by the works. The results of Marine Geology, Oceanography and Physical Processes and Marine Water and Sediment Quality chapters will be used to inform potential impacts relating to smothering and suspended sediments.
284. The existing Dudgeon and Sheringham Shoal Offshore Wind Farm characterisation surveys were undertaken some time ago. Although they provide some context and have been updated by the more recent pre- and post-construction monitoring studies, characterisation for EIA purposes for the proposed extension projects will be based on the latest available data including new site-specific surveys, as described in **Table 2-9** and **Table 2-10**.
285. Natural England has advised that broadscale monitoring of benthic habitats within the Cromer Shoal Chalk Beds MCZ will be undertaken in 2020. Equinor will work closely with stakeholders through the EPP, including with Natural England, to inform the assessment of impacts on the MCZ. The assessment will be undertaken in line with the available guidance (e.g. Defra, 2010; MMO, 2013) and will be informed by a screening process to identify whether the Project is capable of affecting an MCZ, its protected features or any ecological or geomorphological process on which the site is dependant. Where it is necessary, any further MCZ assessment will include a consideration of potential mitigation measures relevant to the achievement of the conservation objectives of the site in question, as set out in Figure 1 of MMO (2013). **Section 1.1.4** contains details of the planned key milestone dates for the assessment, which are subject to confirmation as the EIA process develops.

*Table 2-9 Data sources to be used*

Data source	Date	Data contents
DOW	2012	Dudgeon OWF Environmental Statement
Scira	2006	Sheringham Shoal OWF Environmental Statement
Scira	2014	Sheringham Shoal OWF Second Post-Construction Benthic Monitoring Survey
DOW	2019	Dudgeon OWF Environmental Post Construction Survey Report
MarLIN.ac.uk	2019	Information on the sensitivity of marine habitats and species compiled from existing literature
Natural England and Cefas	Various	Datasets and survey reports available concerning the Cromer Shoal Chalk Beds MCZ
Orsted	2016-2017	Hornsea Three cable corridor geophysical and benthic surveys including: <ul style="list-style-type: none"> <li>Hornsea Three Inshore Geophysical and DDV Survey (2017)</li> <li>Hornsea Three Offshore Cable Corridor Benthic Grab/DDV Survey (2016)</li> </ul>

Data source	Date	Data contents
Equinor	2019-2020	Site specific survey reports (details below)

286. The following surveys will be undertaken to inform the assessment (**Table 2-10**). Surveys will be undertaken in accordance with Ware and Kenny (2011) guidelines and agreed in advance with stakeholders including the MMO, Cefas and Natural England where required.

*Table 2-10 Proposed characterisation surveys*

Survey/study	Timing	Spatial Coverage
Geophysical survey – MCZ Multi-beam bathymetry, side scan sonar and sub-bottom profiler	Late 2019	Cromer Shoal Chalk Beds MCZ
Geophysical survey Multi-beam bathymetry, side scan sonar and sub-bottom profiler	Early – mid 2020	Wind farm arrays, interlink cable corridor, export cable corridor
Grab samples and drop-down camera/ video	Early – mid 2020	Whole site area

287. The site specific surveys will broadly include the following steps:

- Site specific geophysical surveys including multi-beam bathymetry, side scan sonar and sub-bottom profiler;
- Analysis of geophysical data to produce habitat maps; and
- The habitat maps will inform the design of benthic surveys which will include a combination of grab sampling and seabed imagery.

288. Following the identification of the preferred offshore development area, further consultation will be undertaken to agree the data collection approach and methodology for EIA purposes and the specific assessment methodology. A detailed method statement will be developed and agreed with stakeholders as part of the EPP.

## 2.4 Fish and Shellfish Ecology

289. The specific assessment requirements for fish and shellfish ecology are set out within National Policy Statements EN1 and EN-3 (DECC, 2011) and are summarised in **Table A1-4** in **Appendix 1**.

### 2.4.1 Existing Environment

#### 2.4.1.1 Site specific surveys

290. A variety of surveys have been undertaken in relation to the existing Dudgeon and Sheringham Shoal offshore wind farms. Although these surveys were undertaken some time ago, the results provide a good indication of the fish and shellfish assemblage that is likely to be present in the vicinity of the proposed extension projects. However, the information will be updated where necessary through the EIA process (see further details in **Section 2.4.3**) and a summary of the existing survey information is provided below.

291. Otter and beam trawl surveys were conducted in spring and autumn 2008 to inform the Dudgeon EIA (DOW, 2009). The beam trawls recorded a community characterised by pink shrimp (*Pandalus montagui*), the shrimp *Pandalina brevirostris* and long clawed porcelain crab (*Pisidia longicornis*). The otter trawls recorded whiting (*Merlangius merlangus*), dab (*Limanda limanda*), velvet crab (*Necora puber*), brown crab (*Cancer pagurus*) and squid in greatest abundance. Gobies were the principal type of fish caught during autumn beam trawl surveys sampling juvenile fish, followed by common dragonet (*Callionymus lyra*). Elasmobranch species recorded were the Thornback ray (*Raja clavata*) and spotted ray (*Raja montagui*), the starry smooth-hound (*Mustelus asterias*), smooth-hound (*Mustelus mustelus*) and lesser spotted dogfish (*Scyliorhinus canicula*).
292. Otter and beam trawls surveys were also conducted in spring and autumn 2005 to inform the Sheringham Shoal EIA, including trawls inside the proposed SEP (Scira Offshore Energy Ltd, 2006). Pink shrimp, brown shrimp (*Crangon crangon*) and lesser weaver fish (*Echiichthys vipera*) were the dominant species recorded in the beam trawls. Atlantic herring (*Clupea harengus*), velvet crab and whiting were the most abundant species recorded by otter trawls. A Sheringham Shoal post-cable installation elasmobranch survey recorded a single starry smooth-hound in the export cable corridor just south of the wind farm array (Brown & May Marine, 2013).
293. Datasets from both Dudgeon and Sheringham shoal surveys were broadly similar in terms of species composition; however, there were variations in the abundance of species caught.
294. Digital aerial baseline surveys for offshore ornithology and marine megafauna for the proposed DEP and SEP are ongoing and will continue for a period of two years, until April 2020. These surveys have observed seabirds and marine mammals, however an unidentified shark was observed during August 2018 survey.

#### 2.4.1.2 Species of Commercial Importance

295. The fish and shellfish community in the vicinity of the proposed development includes numerous species of commercial importance, particularly shellfish species including whelks, crab and lobster which are targeted by vessels deploying pots and traps. Although non-commercial species may be discarded at sea and are therefore not recorded in fisheries landings data, fisheries statistics nevertheless provide valuable information about fish and shellfish ecology over a broad area.
296. International Council for the Exploration of the Sea (ICES) rectangles are the smallest spatial unit for which landings data is widely available. The proposed DEP and SEP are located within ICES statistical rectangle 35F1 (offshore area), with the export cable corridors passing through both 35F1 and, as they approach landfall, 34F1 (inshore area), shown in **Figure 2.4.1, Appendix 2**. ICES rectangles 34F0 and 35F0 to the east cover areas where impacts are possible, considered as part of the wider regional area in the Dudgeon and Sheringham Shoal ESs (DOW, 2009; Scira Offshore Energy, 2006).
297. **Table 2-11** gives an indication of the fish and shellfish species landed from ICES rectangles 34F0, 34F1, 35F0 and 35F1 (MMO, 2018). Only species that have a landed weight in excess of one tonne over the period between 2013 and 2017 are listed.

Table 2-11 Fish and shellfish species reported in ICES rectangles covering the proposed DEP and SEP and cable corridors (MMO, 2018)

Species		ICES Rectangle			
Common name	Scientific name	34F0	34F1	35F0	35F1
<b>Finfish</b>					
Bass	<i>Dicentrarchus labrax</i>	✓	✓	✓	
Brill	<i>Scophthalmus rhombus</i>				✓
Cod	<i>Gadus morhua</i>	✓	✓	✓	
Dab	<i>Limanda limanda</i>	✓			
Flounder or Flukes	<i>Platichthys flesus</i>			✓	
Gurnard and Latchet	<i>Triglidae</i>	✓			
Herring	<i>Clupea harengus</i>		✓	✓	✓
Mackerel	<i>Scomber scombrus</i>		✓		
Plaice	<i>Pleuronectes platessa</i>	✓			✓
Sole	<i>Solea solea</i>	✓	✓	✓	✓
Sprat	<i>Sprattus sprattus</i>		✓		
Turbot	<i>Scophthalmus maximus</i>				✓
Whiting	<i>Merlangius merlangus</i>			✓	
<b>Elasmobranchs</b>					
Blonde ray	<i>Raja brachyura</i>		✓		✓
Dogfish	<i>Scyliorhinidae</i>	✓			
Lesser spotted dogfish	<i>Scyliorhinus canicular</i>	✓	✓		
Smooth-hound	<i>Mustelus mustelus</i>	✓	✓		
Thornback ray	<i>Raja clavata</i>	✓	✓	✓	✓
<b>Crustaceans</b>					
Brown shrimp	<i>Crangon crangon</i>	✓	✓	✓	✓
Crab	<i>Cancer pagurus</i>	✓	✓	✓	✓
Green shore crab	<i>Carcinus maenas</i>			✓	
Velvet crab	<i>Necora puber</i>			✓	
Lobster	<i>Homarus gammarus</i>	✓	✓	✓	✓
Pink shrimp	<i>Pandalus montagui</i>	✓		✓	
<b>Molluscs</b>					
Cockle	<i>Cerastoderma edule</i>	✓	✓	✓	✓
Mussel	<i>Mytilus edulis</i>	✓		✓	
Scallop	<i>Pectinida spp.</i>	✓		✓	✓
Whelk	<i>Buccinum undatum</i>	✓	✓	✓	✓



298. Within rectangles 34F1 and 35F1, the species landed in greatest quantities are whelk, crab and lobster; whereas cockles, brown shrimp and whelks are landed in the greatest quantities from the regional rectangles 34F0 and 35F0 to the west of the proposed development.

### 2.4.1.3 Spawning and nursery areas

299. **Table 2-12** lists the species which have spawning or nursery grounds identified as coinciding with the proposed development, as well as the importance of these species both commercially and in terms of conservation status.

*Table 2-12 Spatial overlap between the proposed DEP and SEP, offshore cable corridors; and spawning and nursery areas of key species (Coull et al., 1998; Ellis et al., 2012).*

Species	Spawning	Nursery	Commercial Importance	Conversation Designation
Sandeel	Y	Y	Low	UK BAP
Whiting	Y	Y	Medium (commercial value has increased)	UK BAP, IUCN (least concern)
Lemon sole	-	Y	Low	-
Sole	Y	-	High	UK BAP
Cod	-	Y	Medium	UK BAP, OSPAR, IUCN (vulnerable)
Herring	Y	Y	Medium	UK BAP, IUCN (least concern)
Mackerel	-	Y	Low	UK BAP, IUCN (least concern)
Plaice	-	Y	High	UK BAP, IUCN (least concern)
Thornback ray	-	Y	Medium	OSPAR, IUCN (near threatened)

300. Herring in the region spawn from August to October, preferring to lay their eggs on the seabed on clean gravel substrates. This specific seabed spawning habitat preference makes herring sensitive to activities that disturb the seabed, with herring also being sensitive to underwater noise. Surveys undertaken to inform the Dudgeon ES (DOW, 2009) did not identify the presence of spawning aggregations in the area of the wind farm although, as shown in **Table 2-12**, the proposed development is located within a potential herring spawning area. Sheringham Shoal fish surveys recorded immature herring in April, supporting the general classification of the areas as a herring nursery (Scira Offshore Energy, 2006). However, sediment characteristics in the area of the existing and proposed wind farms are set within the context of a very wide area of equal or superior quality spawning habitat (MarineSpace *et al.*, 2013). Available data suggests that there is little evidence of herring spawning in the area and larval studies (including International Herring Larvae Surveys) indicate that the area is generally sparse in recorded larval presence.



## 2.4.2 Potential Impacts

301. The Fish and Shellfish Ecology assessment is likely to have key inter-relationships with Marine Physical Processes, Marine Water and Sediment Quality, Benthic and Intertidal Ecology and Offshore Ornithology and these will be considered where relevant throughout the EIA process.

### 2.4.2.1 Potential Impacts During Construction

302. Potential impacts on fish and shellfish ecology during construction may result from physical disturbance of seabed habitats, suspension of sediment during cable and foundation installation works (including seabed preparation), and any associated deterioration of water quality. Underwater noise generated by construction activities, particularly if pile driving or UXO clearance is required, may result in disturbance and displacement of acoustically sensitive fish species (e.g. herring) and affect spawning and nursery areas. The impacts of wind farm construction will be considered separately from the export cable corridor, however potential interactions between the two will also be considered.

### 2.4.2.2 Potential Impacts During Operation

303. Potential impacts on fish and shellfish ecology during operation will primarily result from loss of habitat and changes to seabed substrata from the physical presence of infrastructure (i.e. foundations and any cable/scour protection above the seabed). Maintenance activities may also result in disturbance to seabed habitats; these would be of a similar type to those during construction but at a lower magnitude. Potential impacts from electromagnetic fields (EMF) from operational subsea cables will also be considered.

### 2.4.2.3 Potential Impacts During Decommissioning

304. It is anticipated that the impacts associated with decommissioning would be similar to those during the construction phase, although the magnitude of effect is likely to be lower (for example, noise impacts would be lower as there would be no piling).

### 2.4.2.4 Potential Cumulative Impacts

305. There is the potential for cumulative impacts with a range of other plans, projects and activities namely the existing Dudgeon and Sheringham Shoal offshore wind farms, other nearby offshore wind farms at planning, construction, operation and decommissioning phases, aggregate and dredging activities, subsea cables and oil and gas activity. These will be identified and assessed in line with the approach set out in **Section 1.6**.

### 2.4.2.5 Potential Transboundary Impacts

306. There is potential for transboundary impacts on fish populations which may be highly mobile. Potential transboundary impacts, including those associated with underwater noise, will be assessed as with the other cumulative impacts and the Applicant, where possible, will liaise with developers in other Member States to obtain up to date project information to inform the assessment.

### 2.4.2.6 Summary of Potential Impacts

307. A summary of potential impacts is provided in **Table 2-13** below.

*Table 2-13 Summary of impacts relating to fish and shellfish (scoped in ✓, scoped out x)*

Potential Impacts	Construction	Operation	Decommissioning
Physical disturbance and temporary loss of sea bed habitat, spawning or nursery grounds during intrusive works	✓	x	✓
Permanent habitat loss	x	✓	x
Increased suspended sediments and sediment re-deposition	✓	✓	✓
Re-mobilisation of contaminated sediment during intrusive works	✓	✓	✓
Underwater noise impacts to acoustically sensitive species during foundation piling	✓	x	x
Underwater noise impacts to acoustically sensitive species due to other activities (vessels, seabed preparation, cable installation, turbine operational noise etc.)	✓	✓	✓
Introduction of wind turbine foundations, scour protection and hard substrate	x	✓	x
Impacts from electromagnetic fields	x	✓	x
Impacts on commercially exploited species associated with their displacement from the area of activity / works	✓	✓	✓
Cumulative impacts	✓	✓	✓
Transboundary impacts	✓	✓	✓

### 2.4.3 Approach to Assessment and Data Gathering

308. Given that fish and some shellfish are highly mobile and range over large areas, data sets with large scale coverage can be useful for characterising the community likely to be present within a site. A key source of information describing the fish community comes from fisheries landings data (see **Table 2-14**). Fisheries data provides information on the broad scale spatial and temporal distribution of fishing effort and species landed, and will be integrated in detail for the assessment. However, fisheries reporting is largely limited to commercial species with many non-commercial species discarded at sea.

309. Other relevant information sources, including fishery-independent surveys such as the Cefas North Sea groundfish survey / International Bottom Trawl Survey (IBTS), will be reviewed and integrated into the assessment.
310. Pre and post-construction fish monitoring surveys undertaken for Dudgeon and Sheringham Shoal (see **Table 2-14**) provide some insight into the fish communities in and in close proximity to the proposed development and will be used to help inform assessment of the potential impacts of wind farm construction and operation on fish and shellfish ecology where appropriate.
311. A program of geophysical and benthic sampling will be undertaken across the proposed wind farm areas and export cable corridors (see details in **Section 2.3**). This will provide valuable information to characterise the seabed (including particle size analysis), alongside information on the benthic assemblage in general.
312. Monthly aerial surveys of the proposed extension areas including a 4km buffer around the sites are being completed. Although the primary purpose of these surveys is to collect data on the distribution of seabirds and marine mammals, they will also identify any large fish (namely elasmobranchs) near the sea surface.
313. As part of the EIA process, the existing environment with respect to fish and shellfish ecology will be described, including the following baseline information:
- Spawning and nursery grounds;
  - Feeding grounds;
  - Shellfish production areas;
  - Overwintering areas for crustaceans; and
  - Migration routes.
314. **Table 2-14** below identifies the desk-based sources that will be accessed to inform the characterisation of the existing environment.

*Table 2-14 Data sources used*

Data source	Date	Data contents
Dudgeon Offshore Wind Farm Fish and Shellfish EIA Characterisation Surveys	May and October 2008	Otter trawls, beam trawls and sand eel trawls (for herring) in and around the Dudgeon wind farm site and export cable corridor.
Sheringham Shoal Offshore Wind Farm Fish and Shellfish EIA Characterisation Surveys	April, July and September 2005	Otter (April) and beam trawls in and around the now existing wind farm site and cable corridor.
Sheringham Shoal Offshore Wind Farm Fish and Shellfish Post Construction Surveys <ul style="list-style-type: none"> <li>• Sheringham Shoal Wind Farm Post-cable Installation Elasmobranch Surveys</li> </ul>	November 2012 and August 2013	Baited longlines were deployed at nine stations along the export cable route.
MMO fisheries statistics – Landings	2014 - 2018	Landing statistics data for UK registered vessels by year, month, ICES rectangle, species live weight

Data source	Date	Data contents
		(tonnes). ICES Rectangles 34F0, 35F0, 34F1 and 35F1.
International bottom trawl survey (IBTS)	2008 - 2019	North Sea IBTS - Species landed from stations in ICES Rectangles 35F0, 34F1 and 35F1.
Greater North Sea International Quarter 3 Otter Trawl Groundfish Survey Monitoring and Assessment Data (Moriarty and Greenstreet 2017)	1998 - 2016	North Sea.
Fish spawning and nursery grounds (Coull <i>et al.</i> , 1998; Ellis <i>et al.</i> , 2012))	-	Both studies map the distribution of predicted spawning and nursery habitats of a number of key species in waters around the UK.
International Herring Larval Survey (IHLS)	1967-2018	North Sea
Environmental Effect Pathways between Marine Aggregate Application Areas and Atlantic Herring Potential Spawning Habitat	2013	Regional Cumulative Impact Assessments.
Digital aerial surveys	May 2018 to April 2020	Provides information on seabirds, marine mammals and potentially large elasmobranch species that transit through the proposed DEP and SEP and surrounding 4km.
Consultation with fishing industry, EIFCA and FLO	2019-2020	Coverage includes proposed extension areas

315. Assessment of impacts will be informed through reference to sources describing the fish and shellfish species present, monitoring results from operational offshore wind farms, the findings from industry-wide studies (e.g. COWRIE funded research) such as those on EMF and piling noise impacts, as well as information obtained through consultation with local sea fisheries committees and commercial fishermen. With regard to noise, it is likely that modelling will be undertaken utilising site-specific physical parameters (geology and bathymetry) and project specific details.
316. The existing data described in **Table 2-14** available for this area is sufficient to undertake a robust assessment, as such further site specific surveys in addition to those outlined above will not be undertaken.

317. Following the identification of the preferred offshore development area, further liaison with the key stakeholders (MMO, Natural England, EIFCA and Cefas) will be undertaken to agree the evidence requirements for the assessment of potential impacts on fish and shellfish ecology. This will include information sources and data collection requirements, as well as the impact assessment approach and methodology. A detailed method statement will be developed and agreed with stakeholders as part of the EPP.

## 2.5 Marine Mammal Ecology

318. The overarching assessment requirements relevant for marine mammal ecology are set out within National Policy Statement EN-1, with more specific assessment requirements set out in NPS EN-3; these are summarised in **Table A1-5** in **Appendix 1**.

### 2.5.1 Existing Environment

319. A review of a number of other survey reports and literature, including the SCANS-III Survey Report (Hammond *et al.*, 2017), the Joint Cetacean Protocol (JCP) Phase III Report (Paxton *et al.*, 2016), and the UK Offshore Energy Strategic Environmental Assessment (OESEA) 3 Report (Department for Energy and Climate Change (DECC) [now the Department for Business, Energy and Industrial Strategy (BEIS)], 2016) indicates that harbour porpoise *Phocoena phocoena* are the most common cetacean species in the southern North Sea, while white-beaked dolphin *Lagenorhynchus albirostris* and minke whale *Balaenoptera acutorostrata* are shown to be present, but considered to be either uncommon (in the case of white-beaked dolphin) or a seasonal visitor in the summer months only (in the case of minke whale).

320. As shown by the Special Committee on Seals (SCOS) (2018) report and seals-at-sea density maps (Russel *et al.*, 2017), both of the UK's resident seal species (grey and harbour seal) are likely to be present in the vicinity of DEP and SEP, potentially in low to moderate densities (see **Figure 2.5.1** and **Figure 2.5.2** in **Appendix 2** for the grey seal and harbour seal density maps respectively, based on the seals-at-sea density data (Russell *et al.*, 2017).

321. The ongoing aerial baseline surveys for the proposed DEP and SEP (see **Section 2.5.3** for more information) have to date recorded a total of four marine mammal species, across 13 surveys between May 2018 and June 2019, including:

- Harbour porpoise: A total of 263 individuals, with relatively higher numbers in the summer months;
- Minke whale: One individual in July (within the DEP site);
- Harbour seal *Phoca vitulina*: A total of 17 individuals in the months of January, April, June, August and October;
- Grey seal *Halichoerus grypus*: A total of 13 individuals throughout the year (January, February, April, May, June, August, September, October and November); and
- Unidentified marine mammals: A total of 74 seals not identified to species level and 25 unidentified marine mammals, either seal or small cetacean species.

322. Key haul-out sites for both seal species are shown in **Figure 2.5.3** in **Appendix 2**. The Blakeney Point haul-out site is located closest to the proposed Project, 12.5km from the nearest Project boundary (including export cable corridors and landfall locations). Other haul-out sites are further from the proposed Project at Horsey (22.5km), Scroby Sands (37.1km), The Wash (57.2km) and Donna Nook (66.7km). There is the potential for seals from these haul-out sites to move along the coast and offshore to forage in and around DEP and SEP (see **Figure 2.5.1** and **Figure 2.5.2** in **Appendix 2**).
323. Through the EIA process, further information sources will be investigated to determine the marine mammal species that have the potential to be impacted by DEP and SEP. It is expected that the key species of interest and therefore the focus of the assessment will be on:
- Harbour porpoise;
  - White-beaked dolphin;
  - Minke whale;
  - Grey seal; and
  - Harbour seal.
324. There are three Special Areas of Conservation (SAC) designated for marine mammal species in proximity of the proposed Project (**Figure 2.5.3, Appendix 2**). These are: The Wash and North Norfolk Coast SAC designated for harbour seal (1.3km from the export cable corridor at the closest point); the Humber Estuary SAC designated for grey seal (60.5km from the project at the closest point); and the Southern North Sea SAC, designated solely for harbour porpoise (the Bacton landfall location is within the SAC 'winter area', where harbour porpoise densities are highest in winter, although the closest point to the wind farm AfL areas is 14.3km from the SAC 'summer area', where harbour porpoise densities are highest in summer). These three designated sites will be considered further for the potential for adverse effects through the assessment process.

## 2.5.2 Potential Impacts

325. The potential impacts from DEP and SEP through the construction, operation and decommissioning phases are outlined below and summarised in **Table 2-15**. All of the potential impacts screened in for further assessment will be related to the potential area of effect, using marine mammal density information from site specific surveys where possible (and the most recent and robust density information publicly available from other sources) to determine the number of marine mammals that could potentially be impacted, and assessed in the context of the relevant reference populations in order to identify the potential for any population effects.
326. The Marine Mammal Ecology assessment is likely to have key inter-relationships with Marine Physical Processes, Marine Water and Sediment Quality, Benthic and Intertidal Ecology, Fish and Shellfish Ecology, and Shipping and Navigation. These will be considered where relevant throughout the EIA process.

### 2.5.2.1 Potential Impacts During Construction

#### *Underwater Noise*

327. The potential impacts from underwater noise on marine mammals are:



- Physical injury and in extreme cases death;
- Permanent auditory injury / permanent loss of hearing sensitivity (Permanent Threshold Shift (PTS));
- Temporary auditory injury / temporary loss in hearing sensitivity (Temporary Threshold Shift (TTS));
- Disturbance and behavioural effects, including auditory masking; and
- Barrier effects.

328. Activities that have the potential to generate underwater noise associated with the construction of DEP and SEP are:

- Clearance of unexploded ordnance (UXO);
- Installation of foundations through pile driving;
- Other construction activities such as seabed preparation, cable laying and rock placement; and
- Construction vessel activity.

329. The potential impact of underwater noise will depend on a number of factors which include, but are not limited to:

- Source levels of noise;
- Frequency relative to the hearing bandwidth of the animal (dependent upon species);
- Propagation range, which is dependent upon;
- Sediment/sea floor composition;
- Water depth;
- Duration of exposure;
- Distance of the animal to the source; and
- Ambient noise levels.

330. An assessment of underwater noise will be undertaken through site specific underwater noise modelling (as outlined in [Section 2.5.3](#)) for all potential noise sources, using the most recent and robust marine mammal thresholds (such as the National Marine and Fisheries Service (NMFS) (2018) Marine Mammal Acoustic Technical Guidance; Southall *et al.*, 2019).

331. The potential impacts associated with underwater noise will be considered fully during the EIA, taking into account the most recent and robust research, guidance and information available.

#### *Vessel Interaction*

332. Collisions between vessels and marine mammals are possible. Despite the potential for marine mammals to detect and avoid vessels, ship strikes are known to occur (Wilson *et al.*, 2007). At present the type and number of vessels to be used during construction is unknown. An increase in vessels could potentially lead to an increase in vessel collision risk, as well as disturbance as a result of underwater noise and the presence of vessels.



333. The increased risk of collision with marine mammals and the disturbance as a result of underwater noise and the presence of vessels will be given further consideration in the EIA, taking into account the most recent and robust research, guidance and information available.

#### *Disturbance at Seal Haul-Out Sites*

334. Increased activity around landfall, including vessel and human activity could have the potential to disturb seals at haul-out sites, particularly during sensitive periods, such as the breeding season and moult period.

335. Disturbance from vessel transits to and from DEP and SEP also has the potential to disturb seals at haul-out sites, depending on the route and proximity to the haul-out sites.

336. Depending on the landfall selected and the vessel routes, there is the potential for disturbance at seal haul-out sites. Therefore, this will be assessed further within the EIA.

#### *Changes to Water Quality*

337. As outlined in **Section 2.2**, the potential for increases in suspended sediments and for the release of contamination during construction has been scoped in for further assessment in the EIA. Therefore, the potential for any impacts on marine mammals or their prey will be determined.

#### *Changes to Prey Resource*

338. As outlined in **Section 2.4**, the potential impacts on fish species and therefore the prey resource for marine mammals during construction can result from physical disturbance and temporary loss of seabed habitat; increased suspended sediment concentrations and sediment re-deposition; and underwater noise, that could lead to mortality, physical injury, auditory injury or behavioural responses, including disturbance and displacement of fish species and effects on spawning and nursery areas.

339. The potential for any changes to the prey resource for marine mammals will be assessed further in the EIA.

### **2.5.2.2 Potential Impacts During Operation**

#### *Underwater Noise*

340. Potential sources of underwater noise during the operation and maintenance phase include:

- Operational turbines;
- Maintenance activities, such as any additional rock dumping and cable re-burial; and
- Operation and maintenance vessel activity.

341. The potential for disturbance from underwater noise during the operation and maintenance phase will be based on the underwater noise modelling and assessment of similar activities for the construction phase.

342. The potential impacts associated with underwater noise will be considered further in the EIA, taking into account the most recent and robust research, guidance and information available.

#### *Vessel Interaction*

343. As outlined above, the increased risk of collision with marine mammals and the disturbance as a result of underwater noise and the presence of vessels will be given further consideration in the EIA. It is anticipated that the impacts associated with vessel activities during operation would be similar to those during the construction phase, although the magnitude of effect is likely to be lower.

#### *Disturbance at Seal Haul-Out Sites*

344. As outlined above, depending on the vessel routes, there is the potential for disturbance at seal haul-out sites. Therefore, this will be assessed further within the EIA. However, it is anticipated that the impacts associated with vessel activities during operation would be similar to those during the construction phase, although the magnitude of effect is likely to be lower.

#### *Physical Barrier Effects*

345. The presence of a wind farm could be seen as having the potential to create a physical barrier, preventing movement or migration of marine mammals between important feeding and / or breeding areas, or potentially increasing swimming distances if marine mammals circumvent the site.

346. The DEP and SEP are not located on any known marine mammal migration routes.

347. Data from operational wind farms show no evidence of exclusion of marine mammals, including harbour porpoise and seals (for example, Diederichs *et al.*, 2008; Lindeboom *et al.*, 2011; Marine Scotland, 2012; McConnell *et al.*, 2012; Russell *et al.*, 2014; Scheidat *et al.*, 2011; Teilmann *et al.*, 2006; Tougaard *et al.*, 2005, 2009a, 2009b).

348. Both harbour porpoise and seals have been shown to forage within operational wind farm sites (e.g. Lindeboom *et al.*, 2011; Russell *et al.*, 2014) indicating no restriction to movements.

349. The spacing between wind turbines would allow animals to move between devices and through the operational wind farm.

350. Therefore, the potential for any barrier effects as result of the physical presence of the wind farms will not be considered further in the EIA. Note that the potential for any acoustic barrier effects as a result of underwater noise during construction will be included as part of the underwater noise assessment.

#### *Electromagnetic Fields (EMF)*

351. Studies indicate that magnetic fields decrease rapidly with vertical and horizontal distance from subsea cables and that the reduction is greater the deeper cables are buried (Normandeau *et al.*, 2011).

352. Although it is assumed that marine mammals are capable of detecting small differences in magnetic field strength, this is unproven and is based on circumstantial information. There is also, at present, no evidence to suggest that existing subsea cables influence cetacean movements.

353. Harbour porpoise are known to move in and out of the Baltic Sea, over several operating subsea cables in the Skagerrak and western Baltic Sea with no apparent effect to their migratory movements. There is also no evidence to suggest that seal species respond to EMF (Gill *et al.*, 2005).
354. In addition, as outlined above, data from a number of operational wind farms show no evidence of exclusion of marine mammals, including harbour porpoise and seals (for example, Diederichs *et al.*, 2008; Lindeboom *et al.*, 2011; Marine Scotland, 2012; McConnell *et al.*, 2012; Russell *et al.*, 2014; Scheidat *et al.*, 2011; Teilmann *et al.*, 2006; Tougaard *et al.*, 2005, 2009a, 2009b).
355. Recent EIAs for other offshore wind farm projects such as Norfolk Vanguard (Norfolk Vanguard Ltd, 2018) only considered the impact of EMF on marine mammal prey species. Therefore, the potential for EMF to impact on marine mammal species directly is proposed to be scoped out from further assessment in the EIA, however, the potential for EMF to impact on marine mammal prey species will be considered.

#### *Changes to Water Quality*

356. As outlined in **Section 2.2**, the potential for changes in water quality during operation has been scoped in for further assessment in the EIA.

#### *Changes to Prey Resource*

357. As outlined in **Section 2.4**, the potential impacts on fish species and therefore the prey resource for marine mammals during operation can result from permanent loss of habitat; introduction of hard substrate; operational noise; maintenance activities; and EMFs.
358. The potential for any changes to the prey resource for marine mammals will be assessed further in the EIA.

#### 2.5.2.3 Potential Impacts During Decommissioning

359. It is anticipated that the impacts associated with decommissioning would be similar to those during the construction phase, although the magnitude of effect is likely to be lower (for example, there would be no piling and therefore impacts from underwater noise would be significantly reduced, although there would still be underwater noise from activities required to remove infrastructure).

#### 2.5.2.4 Potential Cumulative Impacts

360. The Cumulative Impact Assessment (CIA) will identify where the predicted impacts of the construction, operation, maintenance and decommissioning of DEP and SEP could interact with impacts from different plans or projects within the same region and impact sensitive receptors, in this case marine mammals. The marine mammals CIA will assess plans and projects located within the relevant marine mammal Management Unit (MU).

361. In accordance with the Planning Inspectorate Advice Note Seventeen, commercial fisheries will not be considered in the CIA as the potential impacts from commercial fisheries, including direct impact of by-catch of marine mammals, the indirect impact through the loss of marine mammal prey species, and the disturbance from fishing related underwater noise and vessel presence, are considered to be part of the baseline conditions (see **Section 1.6.4.7**).
362. The potential cumulative impacts on marine mammals that will be assessed further in the EIA are:
- Underwater noise;
  - Vessel interaction; and
  - Changes to prey resources (including habitat loss).

### 2.5.2.5 Potential Transboundary Impacts

363. There is a significant level of marine development being undertaken or planned by other EU Member States (i.e. Belgium, the Netherlands, Germany and Denmark) in the southern North Sea. Populations of marine mammals (particularly cetaceans) are highly mobile and there is potential for transboundary impacts especially with regard to noise.
364. In addition, there is potential for the proposed Project to impact on marine mammals from international designated sites.
365. Transboundary impacts will be assessed as with the other cumulative impacts and where possible, in consultation with developers in other Member States to obtain up to date project information to feed into the assessment.
366. The potential for transboundary impacts will be addressed by considering the reference populations and potential linkages to non-UK sites as identified through telemetry studies for seals and ranges and movements of cetacean species.
367. The assessment of the effect on the integrity of the transboundary European sites as a result of impacts on the designated marine mammal populations will be undertaken and presented in the Habitats Regulations Assessment.

### 2.5.2.6 Summary of Potential Impacts

368. **Table 2-15** summarises the potential impacts relating to marine mammals scoped in and out from further assessment in the EIA.

*Table 2-15 Summary of impacts relating to marine mammals (scoped in ✓, scoped out x)*

Potential Impacts	Construction	Operation	Decommissioning
Underwater noise during UXO clearance	✓	x	x
Underwater noise during piling	✓	x	x
Underwater noise from other activities (for example rock placement and cable laying)	✓	✓	✓

Potential Impacts	Construction	Operation	Decommissioning
Underwater noise and presence of vessels	✓	✓	✓
Underwater noise from operational wind turbines	x	✓	x
Barrier effects from underwater noise	✓	x	✓
Collision risk with vessels	✓	✓	✓
Disturbance at seal haul-out sites	✓	✓	✓
Changes in water quality	✓	✓	✓
Changes to prey availability (including from habitat loss and EMF)	✓	✓	✓
Barrier effects from physical presence of wind farm	x	x	x
Electromagnetic fields direct effects	x	x	x
Cumulative impacts from underwater noise	✓	✓	✓
Cumulative impacts from collision risk	✓	✓	✓
Cumulative barrier impacts	x	x	x
Cumulative disturbance at seal haul-out sites	✓	✓	✓
Cumulative changes to prey availability (including habitat loss)	✓	✓	✓
Transboundary impacts	✓	✓	✓

### 2.5.3 Approach to Assessment and Data Gathering

369. The EIA will be informed by the site specific surveys outlined in **Table 2-16**. The digital aerial survey for offshore ornithology and marine megafauna began in May 2018 and will continue until April 2020, with at least one survey undertaken each month through that period.

*Table 2-16 Baseline surveys*

Survey/study	Timing	Spatial Coverage
Digital aerial survey for offshore	May 2019 to April 2020	The proposed DEP and SEP plus 4km buffer area.

Survey/study	Timing	Spatial Coverage
ornithology and marine megafauna	At least one survey per month	Transect lines with a 2.5km spacing, and 19 transect lines across the survey area.

370. Where possible, data from the site specific surveys will be used to generate density estimates for the sites. This will be considered against wider data sources from around DEP and SEP as well as available information for the southern North Sea. This will include, but not be limited to, available survey data from other offshore wind farms.

371. In addition, all relevant publicly available information will be used to inform the characterisation of the existing environment, including, but not limited to, the data sources listed in **Table 2-17**.

Table 2-17 Potential Data Source

Data source	Date	Spatial Coverage	Data contents
Small Cetaceans in the European Atlantic and North Sea (SCANS-III) data (Hammond <i>et al.</i> , 2017)	Summer 2016	North Sea and European Atlantic waters	Provides information including abundance and density estimates of cetaceans in European Atlantic waters in summer 2016, including the proposed offshore development area.
Management Units (MUs) for cetaceans in UK waters (Inter-Agency Marine Mammal Working Group (IAMMWG), 2015)	2015	UK waters	Provides information on MU for the proposed offshore development area.
Offshore Energy Strategic Environmental Assessment (including relevant appendices and technical reports) (Department of Energy and Climate Change (DECC) (now BEIS, 2016)	2016	UK waters	Provides information for the wider North Sea area.
The identification of discrete and persistent areas of relatively high harbour porpoise density in the wider UK	1994-2011	UK Exclusive Economic Zone (EEZ)	Data was used to determine harbour porpoise SAC sites.



Data source	Date	Spatial Coverage	Data contents
marine area (Heinänen and Skov, 2015)			Provides information on harbour porpoise in the North Sea area.
Revised Phase III data analysis of Joint Cetacean Protocol (JCP) data resources (Paxton <i>et al.</i> , 2016)	1994-2011	UK EEZ	Provides information on harbour porpoise in the North Sea area.
Survey for small cetaceans over the Dogger Bank and adjacent areas in summer 2011 (Gilles <i>et al.</i> , 2012)	Summer 2011	Dogger Bank and adjacent areas	Provides information for wider area.
Seasonal habitat-based density models for a marine top predator, the harbour porpoise, in a dynamic environment (Gilles <i>et al.</i> , 2016)	2005-2013	UK (SCANS II, Dogger Bank), Belgium, the Netherlands, Germany, and Denmark	Provides information for central and southern North Sea area.
Distribution of Cetaceans, Seals, Turtles, Sharks and Ocean Sunfish recorded from Aerial Surveys 2001-2008 (The Wildfowl and Wetlands Trust (WWT), 2009)	2001-2008	UK areas of the North Sea	Provides information for on species in the North Sea area.
MARINELife surveys from ferries routes across the southern North Sea area (MARINELife, 2019)	2017-2019	Southern North Sea	Provides information on species in southern North Sea area.
Sea Watch Foundation volunteer sightings off eastern England (Sea Watch Foundation, 2019)	2018-2019	East coast of England	Provides information on species sighted along east coast of England.
UK seal at sea density estimates and usage	1988-2012	North Sea	Provides information on abundance and density

Data source	Date	Spatial Coverage	Data contents
maps (Russell <i>et al.</i> , 2017)			estimates for seal species.
Seal telemetry data (e.g. Sharples <i>et al.</i> , 2008; Russell and McConnell 2014; Russell 2016)	1988-2010; 2015	North Sea	Provides information on movements and distribution of seal species.
Special Committee on Seals (SCOS) annual reporting of scientific advice on matters related to the management of seal populations (SCOS, 2018).	2018	North Sea	Provides information on seal species.
Counts of grey seal in the Wadden Sea (Brasseur <i>et al.</i> , 2018).	Winter 2017 to Spring 2018	Wadden Sea	Counts of grey seal during moult season.
Counts of harbour seal counts in the Wadden Sea (Galatius <i>et al.</i> , 2018).	August 2018	Wadden Sea	Counts of harbour seal during pupping season.

372. Consultation with key marine mammal stakeholders will be ongoing during the EIA and will include discussion of the best available information to use, for example, to determine species density estimates and define reference populations for the assessment.
373. Underwater noise modelling will be undertaken using the latest and best available information, in particular relating to criteria and thresholds for predicting the noise impact ranges for marine mammal species (e.g. NMFS, 2018; Southall *et al.*, 2019; Lucke *et al.*, 2009).
374. The assessment will be undertaken in accordance with following standards, legislation and guidance, including but not limited to:
- The Habitats Directive and Habitats Regulations;
  - National and International Legislation in Relation to Marine Mammals;
  - The relevant NPS requirements, as outlined in **Appendix 1**;
  - The Marine Strategy Framework Directive (MSFD) 2008/56/EC (EC, 2008);
  - The Marine Policy Statement (MPS) (HM Government, 2011); and
  - The East Inshore and East Offshore Marine Plans (HM Government, 2014).
375. The principal guidance documents used to inform the assessment of potential impacts on marine mammals will include, but not be limited to:

- The Protection of Marine European Protect Species (EPS) from Injury and Disturbance: Draft Guidance for the Marine Area in England and Wales and the UK Offshore Marine Area (Joint Nature Conservation Committee (JNCC) et al., 2010);
- Guidelines for Ecological Impact Assessment in the UK and Ireland: Terrestrial, Freshwater and Coastal (Chartered Institute of Ecology and Environmental Management (CIEEM), 2016);
- Environmental Impact Assessment for Offshore Renewable Energy Projects – Guide (British Standards Institution (BSI), 2015);
- Approaches to Marine Mammal Monitoring at Marine Renewable Energy Developments Final Report (Sea Mammal Research Unit Ltd (SMRU Ltd) on behalf of The Crown Estate, 2010);
- Guidelines for Data Acquisition to Support Marine Environmental Assessments of Offshore Renewable Energy Projects (Centre for the Environment and Fisheries and Aquaculture Science (Cefas), 2011); and
- Statutory Nature Conservation Agency Protocol for Minimising the Risk of Injury to Marine Mammals from Piling Noise (JNCC, 2010a) and the Use of Explosives (JNCC, 2010b).

376. The impact assessment will use a matrix approach to assess the potential impacts for marine mammals following best practice and EIA guidance. The data sources summarised above will be used to characterise the existing environment). Each potential impact identified in **Section 2.5.2** has been determined based on experience and using expert judgement. These impacts will be agreed through consultation via the Scoping Process and EPP. An assessment of the impact significance will be made based on the sensitivity, value and magnitude of effect, the definitions of which will be agreed in consultation during the EPP.

377. A detailed method statement, including information sources and data collection requirements, as well as the impact assessment approach and methodology, will be developed and agreed as part of the EPP with the MMO, Natural England, Cefas, The Wildlife Trusts (TWT) and Whale and Dolphin Conservation (WDC).

## 2.6 Offshore Ornithology

378. The specific assessment requirements for offshore ornithology are set out within National Policy Statements EN-1 and EN-3 and are summarised in **Table A1-6** in **Appendix 1**.

### 2.6.1 Existing Environment

379. The ongoing digital aerial baseline surveys conducted at DEP and SEP to date indicate that the key species observed in the areas, and therefore of concern for the impact assessment are:

- Seabirds present during the breeding season: Sandwich tern *Thalasseus sandvicensis*, kittiwake *Rissa tridactyla*, common guillemot *Uria aalge*, razorbill *Alca torda*, gannet *Morus bassanus*, lesser black-backed gull *Larus fuscus*;

- Seabirds present during the non-breeding season: red-throated diver *Gavia stellata*, common guillemot, kittiwake, razorbill; and
- Seabirds present during passage periods: little gull *Hydrocoloeus minutus*, common tern *Sterna hirundo*, Arctic tern *Sterna paradisaea*, skua species.

380. Other seabird and waterbird species which were recorded at various times of the year will be accounted for during the assessment. The same applies to any other species not yet recorded which is found to be present in the study area (**Section 2.6.3.1**) during the second year of baseline surveys.

381. The AfL areas do not overlap with any ornithological designations, although the proposed export cable corridor options pass through the Greater Wash SPA. As breeding seabirds can travel considerable distances from their colonies when foraging it is necessary to give consideration to sites beyond the boundary of the study area, as a proportion of the birds using the habitats within DEP and SEP may originate from SPAs. A figure showing the study area and potentially relevant SPAs is presented in **Figure 2.6.1** in **Appendix 2**.

## 2.6.2 Potential Impacts

382. The Offshore Ornithology assessment is likely to have key inter-relationships with Fish and Shellfish Ecology, Marine Physical Processes, Marine Water and Sediment Quality, and Benthic and Intertidal Ecology. These will be considered where relevant.

### 2.6.2.1 Potential Impacts During Construction

383. The primary direct impact on offshore ornithology receptors during construction is displacement and disturbance of birds due to construction activities and vessel movement during the installation of offshore infrastructure at the offshore wind farm site and the export cable corridor. Indirect impacts on birds through changes in habitat or prey availability are possible and will also be considered. Impacts associated with the wind farm extensions and the export cable route search area will be considered separately and in-combination.

### 2.6.2.2 Potential Impacts During Operation

384. Potential direct impacts on offshore ornithology receptors during operation will result from the presence of turbines and offshore infrastructure, as well as from O&M activities. Collision risk, displacement, disturbance and barrier effects associated with the presence of turbines will all be considered. Displacement and disturbance associated with vessels and maintenance activity and indirect impacts on prey and habitats will also be considered. Displacement and barrier effects of local/resident birds will be considered together, whilst barrier effects in relation to migratory birds will be considered separately.

### 2.6.2.3 Potential Impacts During Decommissioning

385. During decommissioning, the potential impacts are anticipated to be similar to those described above for the construction phase although on a smaller scale. For example, noise impacts would be lower and there would therefore be less indirect impact upon birds through potential disturbance of prey species.

### 2.6.2.4 Potential Cumulative Impacts

386. The cumulative assessment will consider cumulative collision risk, displacement and barrier effects due to the presence of offshore infrastructure when considered alongside other projects. The species that will be included will be determined by the results of the baseline surveys and discussions with stakeholders. They are likely to comprise some or all of the key species listed in **Section 2.6.1**.

### 2.6.2.5 Potential Transboundary Impacts

387. Given the level of offshore wind development in southern North Sea waters by Belgian, Dutch, German and Danish projects, and the fact that birds are highly mobile and migratory, there is potential for transboundary impacts especially with regard to displacement, barrier effects and collision risk. However, the spatial scale and hence seabird reference populations sizes for a transboundary assessment would be much larger than for the UK alone. The assessment will consider these as far as is practicable.

388. Transboundary impacts will be assessed along with other cumulative impacts.

### 2.6.2.6 Summary of Potential Impacts

389. Potential impacts relating to offshore ornithology are summarised in **Table 2-18**.

*Table 2-18 Summary of impacts relating to offshore ornithology (scoped in ✓, scoped out x)*

Potential Impacts	Construction	Operation	Decommissioning
Disturbance and displacement (work activity, vessel movements, presence of turbines and infrastructure, lighting)	✓	✓	✓
Indirect impacts through effects on habitats and prey species	✓	✓	✓
Collision risk with turbines	x	✓	x
Barrier effect due to presence of turbines	x	✓	x
Cumulative impacts (disturbance and displacement, collision and barrier effect)	✓	✓	✓
Transboundary impacts	✓	✓	✓

## 2.6.3 Approach to Assessment and Data Gathering

### 2.6.3.1 Data Gathering

390. A program of digital aerial bird surveys to inform the assessment commenced in May 2018 and is scheduled to collect monthly survey data for 24 months, concluding in April 2020. A polygon encompassing both AfL areas is being surveyed along with a 4km buffer of the polygon (**Figure 2.6.1** in **Appendix 1**). Parallel transects situated 2.5km apart and aligned approximately in a north to south orientation have been selected to ensure that samples are obtained across a wide range of feeding and locational habitats within each transect. In total, the study area includes 19 transects which sample approximately 124.35km<sup>2</sup>, or 10% of the total study area. The transect spacing and survey coverage was considered appropriate given the expected ornithological interests expected at the site, and has been successfully employed at many other offshore wind farm sites in UK waters.
391. As shown on **Figure 2.6.11** in **Appendix 1**, due to a small change in the SEP ‘area of interest’ boundary (as it was termed at the time) in October 2018, a small section of the survey area, at the southern end of the 4km buffer, was not covered between May and September 2018. As the key species present during this part of the year are generally not expected to be impacted by displacement, it is not anticipated that this will reduce the robustness of the assessment.
392. Digital aerial surveys collect data on the species of bird (or group/genus if is not possible to distinguish species), location, numbers, sex and age (where possible), flight heights (though the accuracy of these is potentially not sufficient for some purposes of the assessment; **Section 2.6.3.1**), and flight direction. The assessment will describe the nature of site usage by the birds recorded (e.g. seasonal variation, extent of foraging, overwintering or on passage) in order to determine the importance of the site for seabirds throughout the year relative to the wider area. A list of species recorded to date that are likely to be of significance to the assessment is provided in **Section 2.6.1**.
393. Information from other surveys carried out in the vicinity of the AfL areas will be utilised during the assessment, such as those undertaken for other operational offshore wind farms in the Greater Wash area. This will include GPS tracking on breeding Sandwich terns from the North Norfolk Coast SPA as part of the Dudgeon offshore wind farm post-construction monitoring (Collier *et al.*, 2018, 2017, 2016), and boat-based tracking of breeding Sandwich terns from the North Norfolk Coast SPA undertaken as part of the Sheringham Shoal offshore wind farm post-construction monitoring (Harwood *et al.*, 2018).

### 2.6.3.2 Key Aspects of the Assessment

394. Following the identification of the preferred offshore development area, further liaison with the key stakeholders, Natural England and RSPB, will be undertaken to agree the specific assessment methodology. A detailed method statement will be developed and agreed with these stakeholders as part of the EPP.



395. Detailed data analysis for the assessment will include the calculation of abundance and density estimates (with associated confidence intervals and levels of precision) and will consider seasonal differences in site usage by each key species, as well as the importance of the site for the life stages of each species (breeding and non-breeding adults and sub-adults). Reference populations for each species during different temporal periods for the assessment will be based on the best available information at the time of undertaking the assessment and will be agreed with stakeholders. Consideration of SPA connectivity will be provided in the assessment and will also be discussed with stakeholders.
396. It is recognised that a key issue for the assessment will be collision risk to Sandwich tern, following the Appropriate Assessment in 2012 leading to the refusal of consent of the Docking Shoal project (DECC, 2012). Investigations are already underway to review the work underpinning that assessment, with a view to updating it using as-built project parameters and more recent information collected from operational offshore wind farms and breeding colonies. The initial steps for this work have been discussed with Natural England and will continue to be addressed with key stakeholders as part of the Ornithology ETG.
397. As set out in **Section 1.3.4** above, Equinor has noted the conclusions of The Crown Estate's 2017 Offshore Wind Extensions Plan HRA (TCE, 2019), which concluded that there is sufficient scope and flexibility for project specific mitigation measures to be applied at the project level by developers to ensure no adverse effects on integrity, alone and in-combination.
398. With respect to the assessment that will be undertaken for DEP and SEP, the use of site-specific flight height data (the collection of which is possible for the majority of records of birds in flight) may be considered for Collision Risk Modelling (CRM), though current advice from the aerial survey contractor, Hi Def Aerial Surveying, is that the errors associated with site-specific flight height data may be greater than is required for this purpose. The secondary option is to use the generic flight height data which has been utilised in many offshore wind applications to date (Johnston *et al.*, 2014a, 2014b), likely using Option 2 of the Band CRM (Band, 2012). A further option specific to Sandwich tern is investigating the use of flight height data obtained during the Sheringham Shoal Offshore Wind Farm post-construction monitoring (Harwood *et al.*, 2018); the potential of this is currently being investigated. It is proposed to keep the approach under review during the assessment process and to consult with stakeholders through the EPP process.
399. The impact assessment will be undertaken in line with the most recent guidance (CIEEM, 2018) and expert opinion. Key guidance documents on specific areas of the assessment such as displacement and collision risk will also be utilised (McGregor *et al.*, 2018; UK SNCBs, 2017, 2014). The sensitivity of each species will be determined based on the size of its population, its conservation status and its known sensitivity to offshore wind farms. Species identified as sensitive receptors will be subject to impact assessment in line with the potential impacts listed above.

400. A wide range of other relevant literature will be consulted during the assessment, for example studies assessing the distribution of seabirds at sea using GPS tracking (Cleasby *et al.*, 2018; Wakefield *et al.*, 2017; Wischniewski *et al.*, 2017), foraging ranges (Opper *et al.*, 2018; Thaxter *et al.*, 2012), flight speeds and behaviour at offshore wind farms (Fijn and Gyimesi, 2018; Skov *et al.*, 2018), and studies on the impacts of offshore wind development on seabirds. Information on these example topics and any other relevant subject areas will be drawn from offshore wind assessments, published and 'grey' literature as required.

## 2.7 Commercial Fisheries

401. The specific assessment requirements for commercial fisheries are set out within National Policy Statements EN-1 and EN-3 and are summarised in **Table A1-7** in **Appendix 1**.

### 2.7.1 Existing Environment

402. The proposed DEP and SEP are located within ICES statistical rectangle 35F1, with the export cable corridors passing through both 35F1 and, as they approach landfall, 34F1 (see **Figure 2.7.1** in **Appendix 2**). ICES rectangles are the smallest spatial unit for which landings data is widely available. These, along with the project footprint, will therefore be used to define the boundaries of the commercial fisheries study area and describe the fishing activity within it. The proposed development is within the jurisdiction of the Eastern Inshore Fisheries and Conservation Authority (EIFCA).

403. The sea off North Norfolk and within the Greater Wash area has long supported exploitable populations of a range of shellfish species, including crab, lobster, cockles, whelks, mussels and brown shrimp. MMO UK fleet landings data from ICES rectangles 34F1 and 35F1 show the most valuable species to be whelk, crab and lobster. Between 2013 and 2017, whelk, crab and lobster generated £4.6 million, £2.8 million and £1.8 million respectively from the combined rectangles.

404. There are several fishing ports within the vicinity of the Dudgeon and Sheringham Shoal offshore wind farms from which fishing vessels potentially access the proposed DEP and SEP areas. These are:

- Blakeney;
- Boston;
- Brancaster;
- Cromer;
- Great Yarmouth;
- Grimsby;
- Kings Lynn;
- Lowestoft;
- Sheringham; and
- Well-next-the-Sea.

405. The majority of fishing vessels targeting the area in and around the proposed extensions are UK-based. Dutch and Belgian beam trawlers have been recorded operating to the east of the extension areas (DOW, 2009).

406. Non-UK vessels do not generally have rights to fish within the 12nm limit. However, there are allocated zones, typically between 6nm and 12nm from shore, where historic rights allow access by the fishing fleets of authorised EU Members States (DOW, 2009). The proposed DEP is located entirely beyond 12nm but the proposed SEP straddles the 12nm limit, and the Bacton export cable corridor passes through an area of Belgian historic fishing rights, as shown in **Figure 2.7.1** in **Appendix 2**.

407. Historical consultation with local fishermen undertaken for the Dudgeon ES suggests that the proposed development is located within extensive potting grounds targeting crab and lobster (DOW, 2009). The Dudgeon North Extension and potentially the Dudgeon South Extension may be located within whelk potting grounds identified by the consultation (DOW, 2009).

## 2.7.2 Potential Impacts

408. The Commercial Fisheries assessment is likely to have key inter-relationships with Fish and Shellfish Ecology, which also has inter-relationships with Marine Geology, Oceanography and Physical Processes, Marine Water and Sediment Quality, and Benthic and Intertidal Ecology. There is also the potential for inter-relationships with Shipping and Navigation. These will be considered where relevant.

### 2.7.2.1 Potential Impacts During Construction

409. Potential impacts during construction will be associated with changes in fish abundance / resource (see [Section 2.4](#)) or restricted access to fishing areas (i.e. from construction safety zones). Impacts to be assessed will include loss of, or restricted access to fishing areas, disturbance or displacement of commercial species, increased collision risk ([Section 2.8](#)) or risk of gear loss.

### 2.7.2.2 Potential Impacts During Operation

410. Potential impacts during operation will focus on the permanent presence of offshore structures and vessel operations associated with maintenance activities, including any safety exclusion zones. Areas between turbine structures have generally been open to fishing activities during the operation of the existing Sheringham Shoal and Dudgeon wind farms, except where limited-duration maintenance activities have been necessary. The assessment will include impacts to stocks of commercially exploited species, permanent loss of fishing grounds, effects associated with displacement of fishing activity, increased collision risk (see [Section 2.8](#)) and risk of gear loss. It is anticipated that the installation of larger turbines at a lower density within the extension AfL areas (relative to the parent wind farms) will reduce the footprint of offshore structures and reduce any effects of the wind farm array areas on fishing activities.

### 2.7.2.3 Potential Impacts During Decommissioning

411. It is anticipated that the impacts associated with decommissioning would be similar to those during the construction phase. Foundations are likely to be removed at or below the seabed and cables may also be removed. A decommissioning plan will be developed and approved by the Regulatory Authorities to ensure that any hazards to fishing activities are identified and either removed or marked clearly on charts, which will mitigate the risk. The result of decommissioning is likely to be an increase in available fishing grounds.

### 2.7.2.4 Potential Cumulative Impacts

412. Cumulative impacts from the proposed development, other offshore wind farms and marine activities are possible. They will be considered as part of the assessment where consultation with the fishing industry confirms that such interactions are a concern. Those identified will be assessed in line with the approach set out in **Section 1.6**.

### 2.7.2.5 Transboundary Impacts

413. There is potential for transboundary impacts upon fisheries, particularly with regard to Dutch and Belgian vessels and the displacement of fishing effort, potentially into international waters. Consultation with stakeholders in other EU Member States will be undertaken, and the most up to date information on fisheries, plans and projects in the adjacent waters of other Member States will be used to inform the assessment.

### 2.7.2.6 Summary of Potential Impacts

414. Potential impacts relating to commercial fisheries are summarised in **Table 2-19**.

*Table 2-19 Summary of impacts relating to commercial fisheries (scoped in ✓, scoped out x)*

Potential Impacts	Construction	Operation	Decommissioning
Impacts on commercially exploited species associated with their displacement from the area of activity / works	✓	✓	✓
Displacement of fishing activity leading to increased pressure on other areas outside the wind farm sites	✓	✓	✓
Loss of, or restricted access to, traditional fishing grounds	✓	✓	✓
Loss of, or damage to, fishing gear	✓	✓	✓
Increased collision risk	Included in shipping and navigation assessment	Included in shipping and navigation assessment	Included in shipping and navigation assessment
Increased transit times to reach fishing grounds	✓	✓	✓
Cumulative impacts with other activities	✓	✓	✓
Transboundary impacts	✓	✓	✓

### 2.7.3 Approach to Assessment and Data Gathering

415. As part of the EIA process, the existing environment with respect to commercial fisheries will be described, including, but not limited to the following which will be described in detail in a technical report:

- An overview of fishing activity in the study area:
  - Identifying major commercial fish and shellfish species and their seasonality;
  - Past and present status of fisheries;
  - Details of fishing gears used; and
  - Vessels, gear and operating patterns.
- Details of principal fishing fleets in the study area derived from:
  - Surveillance sightings;
  - Landings data;
  - Vessel Monitoring System (VMS) data; and
  - Consultation with the fishing community, including information available from the existing Sheringham Shoal and Dudgeon wind farms.

416. Identification of potential sensitive receptors will be undertaken using existing studies from nearby wind farm sites and discussions with the EIFCA, the current Dudgeon and Sheringham Shoal FLO, and the local fishing fleet.

417. **Table 2-20** below identifies the desk-based sources that will be accessed to inform the characterisation of the existing environment.

*Table 2-20 Desk-based data sources to be used to inform the assessment*

Data source	Estimated Date	Data contents
UK Marine Management Organisation (MMO) fisheries statistics	2009-2019	Landing statistics data for UK registered vessels by year, month, ICES rectangle, vessel gear type, port of landing, species live weight (tonnes) and value. UK vessels landing into UK and European ports. Non-UK vessels landing into UK ports.
UK MMO Surveillance Sightings	2016-2020	Sightings of vessels by gear type (all nationalities) recorded in UK waters on weekly surveillance fly overs during daylight hours. Recording sighting date; ICES rectangle; ICES sub square; latitude; longitude; vessel/gear type; activity; nationality; course; speed; and number of sightings.
UK MMO Satellite Tracking (VMS) data	2016-2020	Fishing activity for UK registered vessels 15m and over. Aggregated VMS locations recorded in 0.05° by 0.05° grids from UK vessels only in European waters.
Belgian, French and Dutch vessel VMS data and landings from the study area	As available	Vessel activity and effort data, and landings data to non-UK ports will be sourced, where available, from other EU Members States and presented in the ES.

Data source	Estimated Date	Data contents
Consultation with fishing industry, EIFCA and FLO	2019-2020	Coverage includes proposed extension areas
DOW Environmental Statement – Section 13 Commercial Fisheries	2009	Coverage includes proposed extension areas
Scira Offshore Energy Sheringham Shoal Offshore Wind Farm Environmental Statement – Section 12 Commercial Fisheries	2006	Coverage includes proposed extension areas. Although dated, this provides historic environmental baseline information from prior to the construction of Sheringham Shoal and Dudgeon.

418. The potential impacts of the wind farms on commercial fisheries receptors that will be taken forward for assessment will be as specified in the Cefas and MCEU (2004) guidelines for offshore wind developments.
419. Following the identification of the preferred offshore development area, further liaison with the relevant parties such as the MMO, EIFCA and FLO will be undertaken to agree the specific evidence requirements for the assessment of potential impacts on commercial fisheries. This will include information sources and data collection requirements, as well as the impact assessment approach and methodology.

## 2.8 Shipping and Navigation

420. The specific assessment requirements for Shipping and Navigation are set out within National Policy Statement EN-3 and are summarised in Table A1-8 in [Appendix 1](#).

### 2.8.1 Existing Environment

421. The DEP and SEP will be located within the southern North Sea where busy shipping routes exist. As illustrated in [Figure 2.8.1](#) in [Appendix 2](#), there are shipping routes in between the existing Dudgeon and Sheringham Shoal Offshore Wind Farms and also between Sheringham Shoal Offshore Wind Farm and the North Norfolk coast. Shipping density on each of these routes is estimated at between 1,500 and 6,000 vessel transits per annum (MMO, 2017). The proposed wind farm extensions largely avoid these routes, however the DEP and SEP export cables will cross them. There are no IMO routing measures in the vicinity of the proposed wind farm extensions.



422. The routes are used by a variety of vessels, primarily cargo vessels, tankers and passenger vessels (MMO, 2014). This shipping safely co-exists alongside a number of notable marine activities (see **Figure 2.8.1** in **Appendix 2**) which also contribute to recorded shipping in the area, including:
- Offshore wind farms including the Dudgeon, Sheringham Shoal, Race Bank, Inner Dowsing and Lynn offshore wind farms;
  - Oil and gas activities;
  - Commercial fishing activities (as described in **Section 2.7**);
  - Marine aggregate dredging activities and dredger transit routes (**Figure 2.8.1** in **Appendix 2**);
  - Disposal sites;
  - Recreational activities (sailing yachts and motor craft including fishing, water sports and SCUBA diving); and
  - Search and Rescue (SAR) activities.
423. An assessment of these activities using historical and current data will be undertaken to inform the ES and a Navigational Risk Assessment (NRA).

## 2.8.2 Potential Impacts

424. The Shipping and Navigation assessment is likely to have key inter-relationships with Commercial Fisheries, Other Marine Users, and Aviation and MoD. These will be considered where relevant.

### 2.8.2.1 Potential Impacts During Construction

425. Potential impacts to shipping and navigation arising through the construction activities include:

#### *Displacement of activities*

426. Vessel activities and routeing currently undertaken within the proposed wind farm sites and export cable corridors would be displaced during construction due to the presence of buoyed construction areas (including 500m rolling safety zones around fixed structures where work is being undertaken), construction vessels and partially completed or pre-commissioned structures. This displacement could apply to commercial shipping, commercial fishing vessels, and vessels associated with other the marine activities identified. Although the proposed extension areas avoid the main shipping lanes, any vessels operating within or transiting through the extension areas will be displaced. Offshore export cable installation activities would also displace vessels operating within or transiting through the offshore cable corridors for short periods of time. However, because the proposed extension areas are located outside the main shipping lanes, it is anticipated, subject to the findings of the full EIA, that the level of displacement will be low.

### *Increased collision risk*

427. The presence of construction vessels transiting to the construction site, as well as the presence of stationary vessels within the construction area, would introduce an additional vessel to vessel collision risk. Vessels associated with the construction would include large vessels restricted in their manoeuvrability (for example, heavy lift vessels, jack ups, or cable lay vessels). Furthermore, displacement of vessels from the proposed wind farm extension sites and the cable route may increase the density of vessels in other areas, causing an increased vessel collision risk in those areas. Displacement of vessels should be minimised by the location of the proposed extension areas outside the main shipping lanes, however, any increased collision risk will be assessed by a NRA.

### *Increased allision risk*

428. Although the proposed wind farm extension areas avoid the shipping routes shown on **Figure 2.8.1** in **Appendix 1**, the physical presence of partially completed structures, or completed structures awaiting commissioning, would create an increased vessel to structure allision risk to passing traffic. There is also an increased risk of allision by a vessel operating within the construction boundary to fixed structures, for example, in the unlikely event that a vessel is not under command (NUC) as a consequence of an emergency situation such as a machinery failure on-board. There is a particular risk to vessels actively engaged in fishing within the site, due to the time spent in proximity to the structures when compared to a passing vessel.

### *Interaction with partially completed subsea cables*

429. Prior to completion of the proposed DEP and SEP, export and array cable installation, submarine cables may be unburied (or partially buried) on the seabed. Any exposed cable creates a snagging risk to vessel anchors and fishing gear. Snagging would compromise vessel stability and could also damage subsea cables.

## 2.8.2.2 Potential Impacts During Operation

### *Displacement of activities*

430. Once the wind farm extensions are completed it is assumed that the majority of large commercial vessels would be displaced from transiting through or undertaking any activity within the wind farm site(s), although smaller vessels (e.g. fishing or recreation) may still choose to transit through the site. Any affected vessel routes and activities would already have been displaced during the construction phase of the scheme. The scale of impact would depend on the final size and location of the wind farm, as well as the position and spacing of the structures within the wind farms. Although vessel density data shows that the proposed wind farm extensions avoid the main shipping lanes, some minor displacement could occur. During periods of major maintenance in the operational phase, either within a wind farm site or cable corridor, 500m safety zones may be established around structures where work is being undertaken. These may cause further (temporary) displacement.

*Increased collision risk:*

431. Displacement of shipping has the potential to increase shipping density in other areas, potentially leading to an increased vessel-to-vessel collision risk. As part of the NRA process, the following (vessel-to-vessel) collision scenarios will be modelled:
- Base case without wind farm extensions;
  - Base case with wind farm extension(s);
    - Presence of DEP only.
    - Presence of SEP only.
    - Presence of both Extension Projects.
  - Future case without wind farm extensions (assuming a 10% increase in traffic); and
  - Future case with wind farm extensions (assuming a 10% increase in traffic);
    - Presence of DEP only.
    - Presence of SEP only.
    - Presence of both Extension Projects.
432. The future case increase may be altered from 10% during the NRA process if consultation feedback demonstrates that a change is necessary.
433. It is also noted that during periods of major maintenance, the presence of vessels working at the site(s) or within the offshore cable corridor creates an additional collision risk, particularly as it is likely that major maintenance would require large vessels with restricted manoeuvrability.

*Increased allision risk*

434. The physical presence of the completed wind farm structures would create an increased allision risk to passing traffic during the operational phase. There is also an increased risk of allision by a vessel NUC within the wind farm site(s). As would be the case during the construction phase, there would be a particular risk to vessels actively engaged in fishing within the site, due to the time spent in proximity to the structures when compared to a passing vessel. Potential impacts on commercial fishing activity will be considered in the commercial fisheries assessment. As part of the NRA process, the following (vessel-to-structure and vessels NUC) allision scenarios will be modelled based on a realistic worst-case layout:
- Base case with wind farm extensions; and
  - Future case with wind farm extensions (assuming a 10% increase in traffic).
435. As described above, each scenario will be modelled to assess the presence of the wind farm extensions individually, and together.

*Interaction with subsea cables*

436. Any exposed cables associated with proposed DEP and SEP would create a snagging risk to vessel anchors or demersal fishing gear. Snagging could compromise vessel stability, potentially leading to a vessel capsizing or sinking, and could also damage subsea cables. This impact could be associated with both the export and array cables. Protection methods used for non-buried cables may also pose a risk to vessels in shallow areas (e.g. nearshore), such as recreational and fishing vessels, by reducing under keel clearance.

**2.8.2.3 Potential Impacts During Decommissioning**

437. It is anticipated that the decommissioning impacts would be similar in nature to those of construction, although the magnitude of effect is likely to be lower.

**2.8.2.4 Potential Cumulative Impacts**

438. Given the rate of offshore infrastructure development in the southern North Sea, in both the UK sector and in the waters of other EU Member States, there is the potential for cumulative impacts on shipping and navigation, including that associated with existing wind farms, oil and gas activities, commercial fishing activities, aggregate dredging, and vessel activities associated with recreational activities. These will be identified and assessed in line with the approach set out in **Section 1.6.4**.

**2.8.2.5 Potential Transboundary Impacts**

439. There is potential for transboundary impacts on shipping and navigation. The NRA and ES will consider transboundary activities (including impacts from other offshore wind developments) with regard to vessel routeing and international ports, and the presence of international commercial fishing fleets, if relevant.

**2.8.2.6 Summary of Potential Impacts**

440. Potential impacts relating to shipping and navigation are summarised in **Table 2-21** below.

*Table 2-21 Summary of impacts relating to Shipping and Navigation (scoped in (✓), scoped out (x))*

Potential Impacts	Construction	Operation	Decommissioning
Displacement of vessel routeing activities	✓	✓	✓
Increased collision risk	✓	✓	✓
Increased allision risk	✓	✓	✓
Interaction with subsea cables	✓	✓	✓
Impacts on emergency response resources	✓	✓	✓
Cumulative impacts	✓	✓	✓
Transboundary impacts	✓	✓	✓

### 2.8.3 Approach to Assessment and Data Gathering

441. As part of the EIA and associated NRA, the existing environment with respect to Shipping and Navigation will be described, including, but not limited to the following:

- Existing commercial shipping and navigation routes;
- Oil and gas platforms and other infrastructure;
- Commercial fishing fleet activities;
- Marine aggregate sites and transit routes;
- Recreational activities; and
- Search and Rescue activities.

442. Identification of potential sensitive receptors will be undertaken through a desk-based assessment and in consultation with national and local stakeholders including, but not limited to, the MCA, RNLi, Trinity House, Chamber of Shipping, relevant Port Authorities, National Federation of Fishermen’s Organisation (NFFO) and the Royal Yachting Association (RYA) and other international organisations, where relevant. International stakeholders will be consulted where potential transboundary impacts are identified.

443. **Table 2-22** below identifies the desk-based sources that will be accessed to inform the characterisation of the existing environment.

*Table 2-22 Data sources used*

Data source	Date	Data contents
Marine Traffic Survey AIS data	Most recent year	Vessel movement information within the coastal and offshore area
Marine Accident Investigation Branch (MAIB) maritime incident data	Most recent 10 years	All maritime incident data for UK registered ships
RNLi maritime incident data	Most recent 10 years	Maritime incident data including recreational mariners
Marine aggregates dredging data (Crown Estate and BMAPA)	Most recent year	Location of active or proposed aggregate dredging sites and dredger transit routes
Admiralty Charts (UK Hydrographic Office)	Most up-to-date	Location of: <ul style="list-style-type: none"> <li>- Oil and gas platforms</li> <li>- Pipelines</li> <li>- Oil wells</li> <li>- Anchorage areas</li> <li>- Explosive dumping grounds</li> <li>- Aggregate extraction sites</li> <li>- Licenced disposal sites</li> <li>- Cable routes</li> </ul>
RYA UK Coastal Atlas of Boating (GIS Dataset)	September 2016	Information on recreational cruising activity within 12 nautical miles of the UK coast

Data source	Date	Data contents
Fisheries VMS satellite data	Most recent year	Movement of fishing vessels within the UK coastal area

444. The primary input to the NRA and ES will be up-to-date marine traffic survey data, including AIS, radar, and visual observations. This data will cover a minimum of 28 days, account for seasonal variations, and be collected within 24 months of submission. Surveys will be undertaken in accordance with MCA guidelines outlined below in Paragraph 447 and agreed in advance with stakeholders as required.
445. AIS is required to be fitted aboard all vessels engaged on international voyages of 300 gross tonnage (GT) and upwards, cargo vessels of 500GT and upwards not engaged on international voyages and passenger vessels (carrying 12 or more passengers) irrespective of size built on or after 1<sup>st</sup> July 2002. It is also mandatory for fishing vessels over 15m to carry AIS. Vessels not required to carry AIS may still broadcast voluntarily via AIS Class A or B (a cost-efficient version for non-mandatory vessels) and would also be recorded and assessed as part of the NRA and ES.
446. Vessels within the proposed DEP and SEP sites not broadcasting via AIS will be recorded where possible by radar and visual observation.
447. The assessment for the NRA and ES will be undertaken in accordance with following standards and guidance:
- MCA Marine Guidance Note (MGN) 543 (M+F) Offshore Renewable Energy Installations Guidance on UK Navigational Practice, Safety and Emergency Response Issues (MCA, 2016);
  - MCA Methodology for Assessing the Marine Navigational Safety Risks of Offshore Renewable Energy Installations (MCA, 2015);
  - International Maritime Organisation (IMO) guidelines for Formal Safety Assessment (IMO, 2018); and
  - MCA Marine Guidance Note MGN 372 (M+F) (MGN 372 M+F) Offshore Renewable Energy Installations (OREIs) Guidance to Mariners Operating in the Vicinity of UK OREIs (MCA 2008).
448. Following the identification of the preferred offshore development area, further liaison with stakeholders will be undertaken to agree the approach and methodology to data collection for EIA purposes and the specific assessment methodology. A detailed method statement will be developed and agreed with the MCA as part of the consultation process.
449. The MCA require that their methodology (MCA, 2015) is used to prepare an NRA, including an IMO Formal Safety Assessment (FSA). The NRA would have a baseline data gathering phase broadly similar to the EIA, which would include marine traffic surveys, desk-based assessment and consultation to allow the identification of higher risk areas. This phase is then followed by the FSA, in line with the IMO FSA Process (IMO, 2002) and the DECC guidance (DECC, 2013). Both the NRA and the EIA will produce an assessment of the risks posed by a development to shipping and navigation, and present the mitigation required to minimise these risks.



450. The results of the baseline assessment will be used to identify the potential impacts arising from the construction, operation, and decommissioning of the proposed development relevant to shipping and navigation. Where a pathway exists through which an impact can be transmitted to a receptor, the overall “severity of consequence” is determined. This process requires a degree of subjectivity and professional judgement; therefore, the assessment will incorporate the output of consultation with national and local stakeholders relevant to shipping and navigation, and the lessons learnt from existing developments.
451. Following completion of the NRA, impacts that have a clear pathway of effect on receptors would be considered as part of the FSA process and would therefore be detailed within the ES.
452. The MCA MGN 543 (MCA, 2016) highlights issues that need to be taken into consideration when assessing the impact on navigational safety from offshore renewable energy developments in the UK. Specific annexes of the guidance that address particular issues include:
- Annex 1: Site position, structures and safety zones;
  - Annex 2: Developments, collision avoidance and communications;
  - Annex 3: MCA’s wind farm shipping template for assessing wind farm boundary distances from shipping routes;
  - Annex 4: Safety and mitigation measures recommended for OREI during construction, operation and decommissioning; and
  - Annex 5: SAR and emergency response matters.

## 2.9 Offshore Archaeology and Cultural Heritage

453. The specific assessment requirements for offshore archaeology and cultural heritage (historic environment) are set out within National Policy Statement EN-1 and are summarised in **Table A1-9** in **Appendix 1**

### 2.9.1 Existing Environment

454. The Historic Seascape Character (HSC) of coastal and marine areas around England has been mapped through a series of projects funded by Historic England and consolidated into a single national database (LUC, 2017a, 2017b, 2017c). The key cultural processes which form the HSC within the offshore scoping area (below MHWS, including the intertidal zone) include:
- Palaeolandscapes (as part of the 10,000 year old land mass that bridged England with what is now main land Europe);
  - World War II defence area (within the intertidal and coastal strip at the landfall only);
  - Wreck hazards and both historic and current navigation activities (indicative of high historic maritime activity and the potential for maritime remains);
  - Fishing (including bottom trawling, drift netting, fishing grounds, fixed netting and potting) both historic (from the Medieval period onwards) and current; and
  - A current industry and communications character associated with renewable energy, hydrocarbon pipelines and submarine telecommunications cables.

455. Previous offshore archaeological assessments undertaken for both Dudgeon Offshore Wind Farm and Sheringham Shoal Offshore Wind Farm have demonstrated the presence of archaeological remains, and high potential for further archaeological remains to be present on, or buried within, the seabed, as yet undiscovered.
456. Geoarchaeological assessment undertaken for the Dudgeon Offshore Wind Farm led to the identification of a sub-seabed sedimentary sequence charting the transition from late glacial into the early Holocene. Well-dated palaeoenvironmental reconstructions from the North Sea Basin are rare and this new data on changing local physical and vegetation environments, occurring against a background of global climate change and rising sea levels, was one of the first studies from the offshore renewables industry to be published as a scientific paper in a peer-reviewed journal (Brown *et. al.*, 2018). Geoarchaeological recording undertaken for Sheringham Shoal also demonstrated the presence of Holocene deposits, including peat considered likely to correspond to Holocene palaeochannels and terrestrial environments. In addition, possible pre-Devensian Pleistocene deposits were also identified, associated with the “Weybourne Channel” interpreted from the seismic data acquired for the project (Wessex Archaeology, 2006).
457. The assessment of marine geophysical data for both projects also revealed the presence of wrecks, crashed aircraft and geophysical anomalies of possible archaeological interest, a number of which were investigated with a Remote Operated Vehicle (ROV) in conjunction with Unexploded Ordnance (UXO) survey. Identified finds included aircraft propellers and engines, as well as anchors, metal and wooden wreck debris and UXO dating from World War II. A cannon and anchor discovered during the Sheringham Shoal ROV investigations, are now on display in The Mo, Sheringham’s town museum. **Figure 2.9.1** in **Appendix 2** illustrates identified seabed features from previous archaeological assessments.

## 2.9.2 Potential Impacts

458. Heritage assets may be affected by direct physical change or by change in their setting (Historic England – GPA 2, 2015b).
459. Direct impacts to heritage assets, either present on the seafloor or buried within seabed deposits, may result in damage to, or total destruction of, archaeological material or the relationships between that material and the wider environment (stratigraphic context or setting). These relationships are crucial to developing a full understanding of an asset.
460. The DEP and SEP also has the potential to directly and indirectly change the hydrodynamic and sedimentary process regimes, both locally and regionally. Changes in coastal processes can lead to re-distribution of erosion and accretion patterns, while changes in tidal currents, for example, may affect the stability of nearby morphological and archaeological features. Indirect impacts to heritage assets may occur if buried heritage assets become exposed to marine processes, due to increased wave/tidal action for example, as these will deteriorate faster than those protected by sediment cover. Conversely, if increased sedimentation results in an exposed site becoming buried this may be considered a beneficial impact.

461. Impacts to the significance of a heritage asset may also occur if a development changes the surroundings in which a heritage asset is located, experienced and appreciated (i.e. its setting). Similarly, historic character may also be affected if the proposed scheme results in a change to the prevailing character of the area and/or alters perceptions of the seascape.
462. The Offshore Archaeology and Cultural Heritage Assessment is likely to have key inter-relationships with onshore archaeology and cultural heritage, seascape, landscape and visual impact, and marine physical processes. Information from assessments undertaken for these topics will also help to establish potential impacts to the offshore archaeology and cultural heritage resource.

### 2.9.2.1 Potential Impacts During Construction

463. Direct impacts may occur if archaeological material is present within the footprint of DEP and SEP associated with the following activities:
- Seabed preparation (including UXO and boulder clearance);
  - Installation of wind turbine foundations;
  - Installation of ancillary infrastructure;
  - Installation of offshore cabling;
  - Seabed contact by legs of jack-up vessels and / or anchors; and
  - Cable installation at the landfall.
464. Indirect impacts to heritage assets may occur if the physical presence of construction plant and offshore infrastructure impacts the hydrodynamic regime, or if seabed preparation associated with foundation and cable installation leads to localised effects upon sedimentary processes.
465. There would also be potential for temporary impacts to the setting of heritage assets and to the HSC from the presence of vessels associated with the installation of offshore infrastructure and activities at the landfall.

### 2.9.2.2 Potential Impacts During Operation

466. Direct impacts may occur if archaeological material is present within the footprint of works required for routine maintenance activities which disturb the seabed (for example, seabed contact by legs of jack-up vessels and / or anchors) or in exceptional circumstances such that cabling would need replacing, for example. However, given that much of the areas within which such activities would take place would already have been disturbed during construction there would be limited scope for further impact.
467. Indirect impacts to heritage assets may occur if the physical presence of the installed infrastructure impact the hydrodynamic or sedimentary regime including the potential for increased scour around foundations.
468. There would also be potential for impacts to the setting of heritage assets and to the HSC from the presence of the installed infrastructure and ongoing maintenance activities.

### 2.9.2.3 Potential Impacts During Decommissioning

469. If cables and foundations are left in place there would be no potential for direct impact. Direct impacts to heritage assets may occur if the accessible infrastructure is removed, although the anticipated effect on archaeological material would be limited as any remains at the locations of the installed infrastructure will already have been impacted/mitigated during the construction phase. If archaeological material is present within the footprint of jack-ups or vessel anchors deployed during decommissioning activities, direct impacts may also occur.
470. The removal of installed infrastructure has the potential to affect the hydrodynamic regime, and sedimentary processes which in turn may have an indirect impact upon heritage assets.
471. There would also be potential for temporary impacts to the setting of heritage assets and to the HSC from the presence of vessels associated with the decommissioning of offshore infrastructure and activities at the landfall.
472. In general terms, it is anticipated that the decommissioning impacts would be similar in nature to those of construction, although the magnitude of effect is anticipated to be lower.

### 2.9.2.4 Potential Cumulative Impacts

473. Individual heritage assets would not be subject to cumulative direct impacts from other known plans or projects as they are discrete and there would be no physical overlap of different infrastructure. However, although individual assets are discrete, taken together they could have collective heritage significance, therefore multiple impacts upon similar assets could occur cumulatively. In addition, there is potential for multiple developments to affect the larger-scale archaeological features such as palaeolandscapes and to affect the setting of heritage assets and the HSC of the North Sea. There is also the potential for cumulative indirect impacts associated with changes to marine physical processes.
474. There is, therefore, the potential for cumulative impact associated with the construction, operation and decommission of other plans or projects. These will be identified and assessed in line with the approach set out in [Section 1.6.4.8](#).

### 2.9.2.5 Potential Transboundary Impacts

475. Indirect transboundary impacts may occur associated with changes to marine physical processes, where those changes cross an international boundary. Direct transboundary impacts may also occur if wrecks or aircraft of non-British nationality are subject to impact from development. Such wrecks may fall within the jurisdiction of another country, and may include, for example, foreign warships lost in UK waters. Similarly, where palaeolandscapes within the North Sea cross international boundaries, direct transboundary impacts may occur. However, data sharing across national boundaries of data produced through UK offshore wind farm development, and that of the Netherlands, Belgium and Germany, for example, has the potential to result in a significant beneficial transboundary impact.

### 2.9.2.6 Summary of Potential Impacts

476. A summary of potential impacts is provided in **Table 2-23** below.

*Table 2-23 Summary of impacts relating to Offshore Archaeology and Cultural Heritage (scoped in ✓, scoped out x)*

Potential Impacts	Construction	Operation	Decommissioning
Direct impacts to heritage assets.	✓	✓	✓
Indirect impacts to heritage assets associated with changes to marine physical processes.	✓	✓	✓
Change to the setting of heritage assets, which could affect their heritage significance.	✓	✓	✓
Change to character which could affect perceptions of the HSC.	✓	✓	✓

### 2.9.3 Approach to Assessment and Data Gathering

477. As part of the EIA process, the existing environment with respect to offshore archaeology and cultural heritage will be described, including, but not limited to the following:

- Seabed prehistory (i.e. archaeological remains on the seabed corresponding to the activities of prehistoric populations that may have inhabited what is now the seabed when sea levels were lower);
- Maritime archaeology (i.e. the remains of boats and ships and archaeological material associated with prehistoric and historic maritime activities);
- Aviation archaeology (i.e. the remains of crashed aircraft and archaeological material associated with historic aviation activities);
- Historic seascape character (i.e. the attributes that contribute to the formation of the historic character of the seascape); and
- Heritage assets, including surface and buried archaeology (also encompassing palaeoenvironmental deposits) within the intertidal zone below MHWS.

478. The existing baseline and proposed assessment methodologies of potential impact above MHWS will be set out in the onshore archaeology and cultural heritage assessment (see **Section 3.5**).

479. **Table 2-24** identifies the desk-based sources that will be accessed to inform the characterisation of the existing environment with respect to offshore archaeology and cultural heritage.



**Table 2-24 Data sources to be used for the assessment of offshore archaeology and cultural heritage**

Data source	Data contents
United Kingdom Hydrographic Office (UKHO)	Records of wrecks and obstructions data including ‘dead’ and salvaged wrecks that are no longer charted as navigational hazards.
National Record of the Historic Environment (NRHE)	Maritime records, including documented losses of vessels, and records of terrestrial monuments and findspots, including the archaeological excavation index.
National Heritage List of England (NHLE)	Records of designated heritage assets within England, maintained by Historic England. GIS data for all Protected Wrecks, Scheduled Monuments, Listed Buildings, Registered Parks and Gardens and Registered Battlefields.
Norfolk Historic Environment Record (NHER)	Contains data on all recorded non-designated heritage assets, maintained by Norfolk Historic Environment Services (HES). The data includes findspots, monuments and locally listed buildings. Information on previous events (archaeological surveys and investigations) will also be obtained.
British Geological Survey (BGS)	Historic borehole logs and the wider geological background for the region.
National HSC	GIS data and character texts for mapped HSC.
Existing archaeological studies and published sources	Background information on the archaeology of the North Sea and North Norfolk region, including the results of archaeological assessments carried out for the Sheringham Shoal OWF and Dudgeon OWF and recent work undertaken in the wider North Sea.

480. The following surveys / studies will be undertaken between 2019 and 2020 to inform the assessment (**Table 2-25**). In addition, if any geotechnical investigations are completed the samples will be made available for geoarchaeological assessment.

**Table 2-25 Proposed baseline surveys offshore archaeology and cultural heritage**

Survey/study	Timing	Spatial Coverage
Multibeam bathymetry	2019-2020	Extension areas and offshore cable corridor
Side-scan sonar	2019-2020	Extension areas and offshore cable corridor
Sub-bottom profiling	2019-2020	Extension areas and offshore cable corridor
Magnetometer	2019-2020	Extension areas and offshore cable corridor
Walkover survey	2020	Cable corridor at the landfall below MHWS

481. The PEI / ES related assessment will be undertaken in accordance with following standards and guidance:



- JNAPC Code of Practice for Seabed Development (Joint Nautical Archaeology Policy Committee and The Crown Estate, 2006);
- Historic Environment Guidance for the Offshore Renewable Energy Sector (Wessex Archaeology, 2007);
- Guidance for Assessment of Cumulative Impacts on the Historic Environment from Offshore Renewable Energy (Oxford Archaeology, 2008);
- Chartered Institute for Archaeologists' Standard and Guidance for Historic Environment Desk-Based Assessments (2014a) and Code of Conduct (2014b); and
- The Setting of Heritage Assets: Historic Environment Good Practice Advice in Planning 3 (Historic England, 2017)

482. The assessment will broadly include the following steps:

- Marine geophysical survey data, including multibeam echo sounder, side scan sonar, magnetometer and sub bottom profiler data, will be acquired to inform the EIA during 2019/2020. For the purposes of archaeological assessment, processing and interpretation of the marine geophysical data will be carried out by a qualified and experienced archaeological contractor in accordance with industry good practice as set out in available guidance such as Marine Geophysics Data Acquisition, Processing and Interpretation (Historic England, 2013). The results of the assessment will inform a marine archaeological desk-based assessment in support of the ES.
- Pre-consent geotechnical investigations are not currently planned. However, the geoarchaeological assessment of geotechnical data acquired for the project would form an essential part of pre-construction archaeological assessment should the proposed project be granted consent.
- The marine archaeological desk-based assessment will be undertaken to establish the baseline for both known and potential heritage assets within the defined project areas based upon the desk-based sources listed in **Table 2-24** and the results of the archaeological assessment of marine geophysical survey data. Dependent upon the results, a walkover survey at the landfall may be carried out to ground truth existing records of heritage assets and identify any potential unrecorded heritage assets. This may also be required to inform an assessment of potential setting impacts upon heritage assets below MHWS within the intertidal zone.
- Following the identification of the preferred offshore development area, liaison with relevant stakeholders, i.e. Historic England and the Norfolk County Council Historic Environment Service (NCC HES) will be undertaken to further agree the approach and methodology to data collection for EIA purposes and the specific assessment methodologies. A method statement will be developed and agreed with stakeholders (Historic England and the NCC HES) as part of the EPP.

## 2.10 Aviation and MoD

483. The specific assessment requirements for Aviation and Ministry of Defence (MoD) are set out within National Policy Statement EN-1 and are summarised in **Table A1-10** in **Appendix 1**.

### 2.10.1 Existing Environment

484. The airspace within / above and surrounding the proposed Dudgeon and Sheringham Shoal Offshore Wind Farm Extensions is used by a range of both civil and military aircraft as described below and illustrated in **Figure 2.10.1** in **Appendix 2**.

#### *Airports, air traffic services*

485. The nearest UK airport to the Dudgeon and Sheringham Shoal Offshore Wind Farm Extensions is Norwich International Airport, approximately 45.6km to the nearest point of the proposed Sheringham Extension boundary. Northrepps Aerodrome is a small privately-owned airfield located 21km from the nearest point to the proposed Sheringham Extension boundary. Coltishall airfield, previously RAF Coltishall, is located to the north of Norwich International Airport and approximately 37km from the nearest point to the Sheringham Extension boundary. A British aircraft manufacturer, Swift Aircraft, is now based at the airfield using the runway for flights. Royal HaskoningDHV (2013) assessed that the distance to the nearest airfield to the Dudgeon Offshore Wind Farm was too great for an unacceptable hazard to flight safety to occur. Whilst the extension projects weren't assessed and are located closer to the airfield, it is reasonable to conclude that the same applies to the Dudgeon and Sheringham Shoal Offshore Wind Farm Extensions. Flight safety is assessed based on aircrafts take-off and landing. Whilst the distance is shorter, aircraft taking-off and landing will be at an altitude significantly greater than the tallest infrastructure related to any phase of the development.

486. The world is divided into Flight Information Regions (FIR) defining Air Traffic Services (ATS) provision responsibility for aircraft. The Dudgeon and Sheringham Shoal Offshore Wind Farm Extensions lie wholly within the London FIR (under the regulation of the UK Civil Aviation Authority (CAA)).

487. Two civilian radar systems, which provide Air Traffic Control (ATC) services, are relevant in the context of the proposed wind farm extensions. Both are National Air Traffic Services (NATS) operated systems: Cromer located 34km from the proposed development; and Claxby at a distance of 110km.

488. NATS (En Route) (NERL) has produced self-assessment maps for applicants to ascertain whether their proposed developments have an impact upon NERL infrastructure and operations. CAA guidance CAP764 (CAA, 2016) sets out a requirement for a consultation zone within a 10km radius of air-ground-air communication stations and navigation aids, and within a 15 nautical mile radius around secondary surveillance radar infrastructure. Within these consultation zones, NERL would carry out an in-depth assessment of potential impacts. Furthermore, for primary surveillance radars, a simple line-of-sight method has been developed to assist in determining whether a further, more detailed assessment needs to be carried out. Tip heights from 20m to 200m have been considered in describing the areas where turbines of the relevant height would be within line-of-sight of at least one of the primary surveillance radars operated or used by NERL (NATS 2019).

489. As can be seen on **Figure 2.10.1** in **Appendix 2**, the secondary surveillance radar consultation zone extends over the proposed Sheringham Extension AfL area. Furthermore, primary surveillance radars have line-of-sight to turbines with 200m tip height within and beyond the proposed extension areas. With turbine heights up to 276m above HAT (i.e. 38% higher than included by NERL) impacts on NATS navigational aids or radio communication infrastructure cannot be ruled out for the Dudgeon and Sheringham Shoal Offshore Wind Farm Extensions.

#### *Airspace use and restrictions*

490. The airspace in the proposed development area is uncontrolled (i.e. it is not under the radar control of an aeronautical station) and is within what is known as the 'open FIR', meaning the airspace is essentially open for anyone who wishes to use it and without requiring clearance.

491. The proposed extensions are partially situated beneath The Wash Aerial Tactics Area (ATA); airspace regularly used by military aircraft for training with flight levels between approximately 5,000ft – 17,500ft. The area is not designated as a danger area nor as restricted or prohibited airspace and therefore is open to anyone who wishes to use it. Good airmanship would however dictate that non-military aircraft would ensure that flight activity through this airspace is co-ordinated with the appropriate agencies.

492. It was agreed with the MoD that infrared lighting of the Dudgeon OWF required independent testing to ensure compatibility with military night vision goggles (Statoil, 2015). Early engagement will be sought with the MoD on this issue.

493. An agreement has previously been reached with NATS for the existing Dudgeon OWF, employing technical mitigation measures to avoid impacts upon NATS infrastructure and its operations. This agreement, and the applicability of similar technical mitigation, will be considered during the design of the Dudgeon and Sheringham Shoal Offshore Wind Farm Extensions through consultation with NATS from an early stage.

#### *Military airfields*

494. Aircraft operating from Royal Air Force (RAF) stations located in East Anglia (Honington, Marham, Lakenheath, Wattisham, Wittering and Mildenhall) and Lincolnshire (Scampton, Waddington, Cranwell, Barkston Heath, Wyton and Coningsby) may transit through the airspace above the proposed development.

#### *Air Defence Radar (ADR)*

495. The RAF is responsible for the UK's Air Surveillance and Control System which is part of the ADR network. Two UK sites, Trimingham on the North Norfolk coast and Staxton Wold in North Yorkshire, are close enough to the Dudgeon and Sheringham Shoal Wind Farm Extensions that the turbines could be detectable on primary surveillance radar (Royal HaskoningDHV 2013). As set out on **Figure 2.10.1** in **Appendix 2**, secondary surveillance radar areas for Trimingham and Cromer also overlap with the Sheringham Extension AfL area. Impacts on ADR can therefore not be ruled out.

496. Engagement with the MoD to seek agreement on any potential radar issues in the UK with the Dudgeon and Sheringham Extensions will be sought to develop any necessary technical solutions or other mitigation measures prior to construction.

#### *Helicopter operations*

497. A network of Helicopter Main Routes (HMRs) has been established to support the transport of personnel and material to offshore oil and gas installations. CAA Policy and Guidelines on Wind Turbines (CAA, 2016) states that HMRs have no defined lateral dimensions, although 2nm either side of the route centreline should ideally be kept obstacle free. However, it is not mandatory for helicopters to use established HMRs. For example, when operating in good weather conditions, helicopters may route direct to their destination. It may be considered that some turbine development within 2nm of the route centreline could be manageable. Two HMRs traverse the proposed Dudgeon extension areas, HMR 4 crossing Dudgeon South and HMR 5 crossing Dudgeon North and connecting to the Waveney gas platform just north of the Dudgeon North extension boundary (**Figure 2.10.1** in **Appendix 1**).
498. The presence of wind turbines may also restrict helicopter access to platforms (e.g. Waveney) and associated vessels such as drilling rigs, survey and support vessels operating in the vicinity of platforms and/or subsea assets. In order to help achieve a safe operating environment, consultation zones of 9nm radius exist around helicopter-serviced offshore installations. As set out in CAA guidance (2016), these consultation zones do not prohibit offshore wind development within 9nm of offshore installations, but trigger consultation between helicopter operators, the operators of existing installations and offshore wind developers in order to determine a solution that would maintain safe offshore helicopter operations. There are four platforms within 9nm of the proposed extensions (**Figure 2.10.1** in **Appendix 1**) for which consultation will be undertaken. Furthermore, Independent Oil and Gas has approvals for the installation and operation of a normally unmanned production platform, Blythe, and an additional well, Elgood, to be tied back to Blythe (Independent Oil and Gas, 2019). Elgood and Blythe would be located adjacent to the northeastern and eastern boundaries of Dudgeon OWF respectively. If the development proceeds, helicopter access is likely to be required, and consultation will be undertaken as necessary.
499. The proposed extensions are located within the area covered by the Maritime and Coastguard Agency's (MCA) Search and Rescue (SAR) operations. The MCA is responsible for the initiation and coordination of civil maritime SAR within the UK SAR region. The proposed project will lead to a material change in the current operating environment should a SAR helicopter operation be required within or in proximity to the extensions. An Emergency Response Co-Operation Plan (ERCoP) will be compiled in conjunction with the MCA, including SAR corridors with entry and exit locations.

*Meteorological office radar*

500. The closest Met Office radar system is Old Buckenham which, once constructed, will be located 66km from the closest point on the Sheringham Extension AfL boundary.

501. The Statement of the European Union Meteorological Network Operational Programme for the Exchange of weather Radar information (OPERA) Group, on the cohabitation between weather radars and wind turbines, suggests that at 20–45km turbines are generally visible in lowest scan with low impact, and beyond 45km they are generally not observed but can be due to propagation conditions. This is likely the case for single turbines or small onshore wind farms (OPERA, 2010). However, OPERA state that larger wind farms are continually visible even at ranges of up to 90km (OPERA, 2010). Considering the above and the distance between the proposed Dudgeon and Sheringham Shoal Offshore Wind Farm Extensions and the planned Old Buckenham station, potential impacts to weather radar will be considered further in the EIA.

## 2.10.2 Potential Impacts

502. The Aviation and MoD assessment is likely to have inter-relationships with Shipping and Navigation. These will be considered where relevant.

### 2.10.2.1 Potential Impacts During Construction

503. **Effects on aviation radar:** There will be no impact to civilian or military radar resulting from construction activity specifically. There is potential for impacts to arise from the presence of partially constructed wind turbines and this will be considered as part of the assessment during operation.

504. **Risk of aviation collision:** During construction, the presence and movement of construction vessels (e.g. tall cranes) may present an increased potential collision risk to low flying aircraft and helicopter flight operations.

505. **Effects on helicopter operations (including SAR):** Helicopter operators, offshore platform operators and SAR operators may have concerns regarding the physical presence of wind turbines as they are constructed near HMRS and offshore platforms, which could restrict helicopter flightpaths and landing approaches. There are also potential impacts of construction on the available airspace between wind farm related helicopter operations and those associated with oil and gas activity and SAR.

### 2.10.2.2 Potential Impacts During Operation

506. **Effects on aviation radar:** There is potential for the NATS PSR at Cromer to detect the wind turbines leading to induced clutter on Air Traffic Control (ATC) displays. The MoD ADRs at RAF Trimingham and Staxton Wold would theoretically have line of sight to the majority of the Dudgeon and Sheringham Shoal Offshore Wind Farm Extensions wind turbines which, without suitable mitigation, would create operational effects to the ADR. Consultation with these stakeholders will be undertaken to identify any technical mitigation measures that may be required.

507. **Risk of aviation collision:** The wind turbines may be difficult to visually detect from the air in poor meteorological conditions and at night. This could increase collision risk to aircraft and helicopter flight operations.



508. **Effects on helicopter operations (including SAR):** Helicopter operators, offshore platform operators and SAR operators may have concerns relating to the physical presence of the wind turbines. This could be mitigated by re-routing helicopters around the wind farm extensions or constraining the minimum flight altitude of helicopters when operating on the HMR. Such measures may, however, result in an increase in flight distance, requiring helicopters to carry more fuel and thus less payload, and increase logistical cost and safety risk to offshore personnel. There are also potential impacts of operation on the available airspace between wind farm related helicopter operations and those associated with oil and gas activity and SAR.
509. **Impact on military training areas:** The MoD may have concerns relating to the extensions being below an area of military training (The Wash ATA). However, the training area has a Flight level between 5,000ft and 17,500ft which is well above the proposed WTG height and this restricts potential effects to those relating to radar rather than physical obstruction.

### 2.10.2.3 Potential Impacts During Decommissioning

510. **Effects on aviation radar:** Wind turbines within line of sight to civilian or military radar infrastructure could have an impact on aviation radar, as described above. Any such impacts would be of the same magnitude or smaller than during the operational phase and would gradually be reduced to zero as the decommissioning process is completed.
511. **Risk of aviation collision:** Vessels and equipment required in the process of wind farm decommissioning, in particular large cranes and partially decommissioned wind turbines, may present a physical obstruction and effect operations of low flying aircraft and helicopter flight operations.
512. **Effects on helicopter operations (including SAR):** Helicopter operators, offshore platform operators and SAR operators may have concerns relating to partially dismantled wind turbines and the presence of decommissioning vessels. This could be mitigated through re-routing helicopters around the wind farm extensions or constraining the minimum flight altitude of helicopters when operating on the HMR. There are also potential impacts of operation on the available airspace between wind farm related helicopter operations and those associated with oil and gas activity and SAR.

### 2.10.2.4 Potential Cumulative Impacts

513. There is the potential for cumulative impacts of wind turbines causing permanent (project lifetime) interference with a range of other activities namely civil and military aviation radar, other offshore wind farms, and other infrastructure projects and activities in the North Sea. This is particularly relevant in the context of the proposed projects which will extend the footprint and lifetime of the wind farm infrastructure installed at the existing OWFs. The cumulative impacts during construction, operation and decommissioning will be assessed in line with the approach set out in **Section 1.6**.

### 2.10.2.5 Transboundary Impacts

514. Considering the distance that the Dudgeon and Sheringham Extensions are from international boundaries, transboundary impacts are not anticipated and are proposed to be scoped out of the assessment.



### 2.10.2.6 Summary of Potential Impacts

515. A summary of potential impacts is shown in **Table 2-26**.

*Table 2-26 Summary of impacts relating to Aviation and MoD (scoped in ✓, scoped out x)*

Potential Impacts	Construction	Operation	Decommissioning
Effects on aviation radar	✓	✓	✓
Risk of aviation collision	✓	✓	✓
Effect on HMRs and offshore platforms	✓	✓	✓
Effects on military training areas	x	✓	x
Cumulative impacts	✓	✓	✓
Transboundary impacts	x	x	x

### 2.10.3 Approach to Assessment and Data Gathering

516. Identification of potential sensitive receptors will be undertaken through desk-based review of available data (including from the existing Dudgeon and Sheringham Shoal OWFs) and through consultation with stakeholders. Impacts will be assessed in line with industry regulations for safe obstacle avoidance or whether radar separation (from radar clutter) can be maintained in the presence of wind turbines.

517. **Table 2-27** below identifies the desk-based sources that will be accessed to inform the characterisation of the existing environment.

*Table 2-27 Data sources used*

Data source	Date	Data contents
CAA, CAP 764	2016	Policy and Guideline on Wind Turbines - CAA policy and guidance on a range of issues associated with wind turbines and their effect on aviation.
CAA, CAP 670	2014	Air Traffic Services Safety Requirements - Overview of requirements and the regulatory framework, generic requirements and guidance, specific requirements for Air Traffic Control (ATC).
CAA	2017	Visual Flight Rules Chart.
CAA, CAP 393	2016	The Air Navigation: Order 2019 and the Regulations - the rule of the air regulations; the air navigation (general, cosmic radiation, keeping record a dangerous goods) regulations; the permanent air navigation regulations; and the civil aviation authority regulations.
MoD	2014	MoD Obstruction Lighting Guidance.
Wind Energy and Aviation Interests: Interim Guidelines	2002	Details both military and independent airport operator issues and consultation procedures - The Wind Energy, Defence and Civil Aviation Interests Working Group's 2002 Report.

Data source	Date	Data contents
CAA, VFR	2017	Visual Flight Rules Chart- lower airspace rules.
CAA, CAP 032	2018	UK Integrated Aeronautical Information Package (UKIAIP)- main resource for information and flight procedures at all licensed UK airports as well as airspace, en-route procedures, charts and other air navigation information.
CAA, CAP 168	2014a	Standards required at UK National licensed aerodromes relating management systems, operational procedures, physical characteristics, assessment and treatment of obstacles, visual aids, rescue and fire-fighting services and medical services.
MCA, MGN 543	2008	Safety of Navigational Practice, Safety and Emergency Response – contains information for operators and developers in formulating their emergency response plans and site safety management.
Military Aeronautical Information Publications	2018	Eurocontrol Guidance to enable military organisation to implement an harmonised way to elaborate and to publish Military Aeronautical Publications (AIPs) in Europe.
MoD	2011	MoD UK Low-Flying System (UK FLS) Priority Map - Statistics on military low flying training activity conducted in the UK low Flying Systems for the Financial Year.

518. The assessment will broadly include the following steps:

- Desk-based studies including line of sight analysis that would identify and examine aviation, MCA and MoD receptors;
- Consultation and meetings with specific stakeholders in order to provide a detailed understanding of potential impacts; and
- Consenting requirements using guidance from the data sources identified in **Table 2-27**.

519. Following the identification of the preferred offshore development area, further liaison with stakeholders will be undertaken to agree the approach and methodology to data collection for EIA purposes and the specific assessment methodology. It is expected that consultation will be required with the following agencies:

- UK CAA;
- Norwich Airport;
- UK MCA (SAR and Lighting requirements);
- UK meteorological office;
- UK MoD;
- UK NATS / NERL; and
- Oil and Gas Industry (helicopter and platform operators).

## 2.11 Offshore Designated Sites

520. The specific assessment requirements that are applicable to Offshore Designated Sites are set out within National Policy Statement EN-1 and EN-3 are summarised in **APPENDIX 1 NPS ASSESSMENT REQUIREMENTS**.

### 2.11.1 Existing Environment

#### 2.11.1.1 Water Framework Directive (WFD)

##### *Transitional and Coastal Water Bodies*

521. As outlined in **Section 2.2** the two export cable corridor options pass through the Norfolk East coastal water body (GB650503520000). The Weybourne corridor is partly located within the Norfolk North coastal water body (GB640503300000). Both of these water bodies are 'heavily modified' due to flood and flood and coastal protection respectively. The water body status for both is 'moderate' (Environment Agency, 2019a).

522. The Stiffkey & Glaven transitional water body is located approximately 4km west of the Weybourne corridor landfall scoping area. This water body is not designated as artificial or heavily modified, and its status in 2016 was 'Bad' (Environment Agency 2019a).

##### *Bathing Waters*

523. There are five designated bathing waters in the vicinity of the proposed export cable corridors. The closest designated bathing waters are at Mundesley, approximately 610m northeast of the Bacton landfall. Sheringham bathing waters are approximately 2.5km east of the Weybourne landfall. Both have had 'Excellent' bathing water quality status since 2016 (Environment Agency, 2019b).

#### 2.11.1.2 Natura 2000 Sites

524. Both of the proposed export cable corridors pass through the Greater Wash SPA which is designated for breeding seabirds as well as breeding and wintering passage waterbirds (**Figure 2.11.1**). Since many of the Natura 2000 sites in the North Sea are designated for mobile species (e.g. seabirds and marine mammals), or for features with the potential to be indirectly impacted (e.g. by underwater noise or changes to water quality) it is necessary to consider sites beyond the project boundary. **Table 2-28** lists Natura 2000 sites in the vicinity of the proposed development which may have the potential to be impacted. This is not an exhaustive list and a Habitats Regulations Assessment (HRA) screening exercise, to be undertaken as part of the EIA process, will identify those sites on which the proposed development would have likely significant effects.

Table 2-28 Natura 2000 sites in the vicinity of the proposed development.

Site Name	Distance* (km)	Designated Features
Greater Wash SPA	0	Breeding seabirds, breeding and wintering passage waterbirds Non-breeding seabirds
North Norfolk Coast SPA and Ramsar	1	Breeding seabirds, wintering and passage waterbirds
The Wash and North Norfolk Coast SAC	1	Harbour seal Sandbanks, mudflats and sandflats, large shallow inlets and bays, reefs and saltmarshes
Inner Dowsing, Race Bank and North Ridge SAC	2	Sandbanks and reefs
Southern North Sea SAC	14	Harbour porpoise
North Norfolk Sandbanks and Saturn Reef SAC	14	Sandbanks and reefs
Outer Thames Estuary SPA	30	Wintering and breeding seabirds
Breydon Water SPA	34	Breeding seabirds, wintering and passage waterbirds
The Wash SPA and Ramsar	42	Breeding, wintering and passage seabirds, passage and wintering waterbirds.
Gibraltar Point SPA and Ramsar	46	Breeding seabirds, wintering and passage waterbirds
Haisborough Hammond and Winterton SAC	54	Sandbanks and reefs
Humber Estuary SPA and Ramsar	55	Breeding, wintering and passage waterbirds
Minsmere-Walberswick SPA and Ramsar	59	Breeding seabirds, breeding wintering and passage waterbirds
Alde-Ore Estuary SPA and Ramsar	83	Breeding seabirds and breeding, wintering and passage waterbirds
Debden Estuary SPA and Ramsar	84	Wintering and passage waterbirds

Site Name		Distance* (km)	Designated Features
Stour and Orwell Estuaries SPA and Ramsar		94	Breeding, wintering and passage waterbirds Sandflat, mudflat and estuary and lagoons
Flamborough and Filey Coast SPA		115	Breeding seabirds

\*Measured from the closest point of the proposed development scoping area to the closest point of the designated site, rounded to the nearest kilometre.

### 2.11.1.3 Marine Conservation Zones (MCZs)

525. Both of the proposed export cable corridor options pass through the Cromer Shoal Chalk Beds MCZ (**Figure 2.11.1** in **Appendix 2**). The site is designated for features including exposed chalk and peat, which are rare in the North Sea, as well as several other seabed habitat features (see **Section 2.3**).

### 2.11.2 Potential Impacts

526. Potential direct and indirect impacts to designated sites are described in the relevant sections:

- Potential impacts to WFD designated sites and bathing waters are described in **Section 2.2**;
- Potential impacts to offshore sites designated for seabed habitat features are described in **Section 2.3**;
- Potential impacts to SACs designated for marine mammals are described in **Section 2.5**; and
- Potential impacts to SPAs and/or Ramsar sites designated for birds are described in **Section 2.6**.

### 2.11.3 Approach to Assessment and Data Gathering

527. Potential impacts to WFD designations will be assessed within the Marine Water and Sediment Quality chapter of the EIA and through a WFD assessment.

528. Impacts on the MCZ will be assessed within the Benthic and Intertidal Ecology and Marine Geology, Oceanography and Physical Processes chapters of the EIA; and will be supported by an MCZ assessment (see **Section 2.3.3** for further details).

529. A HRA will be undertaken to ascertain if the proposed project will result in likely significant effects on the designated interest features of European protected sites (see **Sections 1.1.4 and 1.3.4**). Where a likely significant effect is identified, information will be provided to address the subsequent requirements of the HRA process.

530. The assessments will be supported by the surveys specified in the relevant topic chapters, and by engagement with regulators and stakeholders as part of the EPP.

## 2.12 Offshore Air Quality

531. The specific assessment requirements for air quality are set out within National Policy Statement EN-1 and are summarised in **Table A1-12** in **Appendix 1**.

### 2.12.1 Existing Environment

532. The main source of atmospheric emissions offshore is likely to be from shipping, and the associated pollutants of concern are nitrogen oxides (NO<sub>x</sub>), particulate matter (PM) and sulphur dioxide (SO<sub>2</sub>).

533. The International Maritime Organisation has enacted regulations to reduce shipping emissions under Annex VI of the International Convention for the Prevention of Pollution from Ships (MARPOL). The North Sea is a designated Emission Control Area under MARPOL, and from 1<sup>st</sup> January 2020 the sulphur content of fuel oil will be limited to 0.5%. It is expected that between 2011 and 2020, sulphur emissions from shipping in UK waters will have fallen by 83% as a result of the MARPOL regulations. Emissions of NO<sub>x</sub> from shipping are projected to increase by 10% between 2011 and 2020 (Defra, 2017) due to an increase in shipping and a lack of regulation of this pollutant.

534. Pollutant concentrations should only be compared to the relevant Air Quality Objectives where there is representative exposure. There are no offshore human receptors which are sensitive to air quality, and marine-based ecological designations are unlikely to be sensitive to air pollution impacts, or they are usually dominated by other sources of inputs (Centre for Ecology and Hydrology, 2019). The main receptors which may be affected would be a small number of isolated locations of relevant human exposure (e.g. residences) close to the shoreline and land-based designated ecological sites.

### 2.12.2 Potential Impacts

#### 2.12.2.1 Potential Impacts During Construction, Operation and Decommissioning

535. Engine exhausts from construction, O&M and decommissioning vessels will provide a small additional contribution to atmospheric emissions from existing sea traffic. The number of vessels required during construction will be minimal and the associated atmospheric emissions will be small in comparison to those from the total shipping in this region of the North Sea. The number and types of O&M and decommissioning vessels are not anticipated to be any greater or substantially different to those required for construction, and therefore the magnitude of air quality effects should not be any greater. Most construction works and O&M works would be carried out at a distance from the shore, being centred on the wind farms themselves.

536. Given the likely negligible increases of air pollutants on site, the regulation of emissions under MARPOL and the distance from any shore-based receptors, it is expected that effects would be insignificant. It is therefore proposed that all offshore air quality impacts should be scoped out from further consideration within the EIA.



### 2.12.2.2 Potential Cumulative Impacts

537. It is unlikely that any significant cumulative air quality impacts would occur, as there are few other sources of pollution offshore. It is therefore proposed that all cumulative offshore air quality impacts should be scoped out from further consideration within the EIA.

### 2.12.2.3 Summary of Potential Impacts

538. A summary of potential impacts is shown in **Table 2-29**.

*Table 2-29 Summary of impacts relating to offshore air quality (scoped in ✓, scoped out x)*

Potential Impacts	Construction	Operation	Decommissioning
Impacts at human receptors	x	x	x
Impacts at ecological receptors	x	x	x
Cumulative impacts	x	x	x
Transboundary impacts	x	x	x

## 2.13 Other Marine Users

539. The specific assessment requirements for Other Marine Users are set out within National Policy Statement EN-3 and are summarised in **Table A1-13** in **Appendix 1**.

### 2.13.1 Existing Environment

540. This section considers interactions with other offshore industries and marine users, except for those already covered as EIA topics in their own right, such as Commercial Fisheries (**Section 2.7**), Shipping and Navigation (**Section 2.8**) and Aviation and MoD (**Section 2.10**). The locations of infrastructure and activities associated with other marine users are illustrated in **Figure 2.13.1** in **Appendix 2**.

#### 2.13.1.1 Offshore wind infrastructure

541. Other nearby operational OWFs include the parent Dudgeon and Sheringham Shoal wind farms; and also Race Bank, Lincs, Inner Dowsing and Lynn OWFs (**Table 2-30**).

542. Export cables for the existing Dudgeon and Sheringham Shoal OWFs make landfall to the west of Weybourne, the Dudgeon export cable route being immediately to the west of the proposed DEP and SEP landfall option at Weybourne and constraining the western boundary of the proposed export cable corridor at the site selection stage. The export cable corridor for the proposed Hornsea 3 offshore wind farm (application currently in examination) makes landfall to the west of Weybourne and also to the west of the proposed DEP and SEP landfall option.

543. The consented Triton Knoll offshore wind farm is 13.2km to the northwest of the Dudgeon North extension, with the export cables making landfall in Lincolnshire. Installation of the offshore array and infrastructure is due to begin in late 2019/early 2020 (Triton Knoll website, 2019).

544. The western boundary of the proposed Sheringham Extension was positioned in order to maintain a minimum 5km separation (in line with The Crown Estate’s requirements) from the proposed Race Bank Extension. However, as a result of The Crown Estate’s plan level Habitats Regulations Assessment, it has been determined that an application to extend the Race Bank OWF will not progress to the award of leasing rights as part of the 2017 extensions round.

*Table 2-30 Offshore wind farm projects in the southern North Sea and their approximate distance from the nearest Dudgeon and Sheringham Extension Projects AfL area*

Offshore Wind Farm	Distance from DEP (km)	Distance from SEP (km)
Race Bank (operational)	19.2	10.0
Triton Knoll (under construction)	13.2	19.2
Lincs (operational)	46.0	34.4
Lynn (operational)	51.3	37.2
Inner Dowsing (operational)	49.7	38.2

### 2.13.1.2 Oil and gas infrastructure

545. The nearest oil and gas infrastructure is associated with the Anglia, Lancelot, and Waveney gas fields. There is no surface oil and gas infrastructure within the proposed extensions or export cable corridors. The Perenco-operated Waveney gas platform is located approximately 0.55km from the northern boundary of the Dudgeon North Extension. There are no active wells located within the proposed extensions or export cable corridors.

546. There is a concentration of pipelines linking southern North Sea gas fields to the Bacton Gas Terminal on the Norfolk coast. The proposed Bacton export cable corridor option has been positioned to minimise the number of pipeline crossings, making landfall north of the Bacton Terminal and west of the associated pipelines (**Figure 2.13.1** in **Appendix 2**). The Shearwater to Bacton gas pipeline is the most easterly of the pipelines routing to Bacton. It traverses the Dudgeon South Extension and routes parallel to the proposed Bacton export cable corridor. The Durango to Waveney gas production pipeline also traverses the proposed Dudgeon North Extension. Gas pipeline PL27, linking the Viking gas field in the east and the Thredlethorpe Gas Terminal on the Lincolnshire coast to the west, routes parallel and approximately 500m from the northern boundary of the proposed Dudgeon North Extension. There are no pipelines in close proximity to the proposed Sheringham Extension.

547. Much of the Dudgeon North Extension overlaps with oil and gas blocks licensed for exploration and production (48/16, 48/17c, 48/17d, 48/18c and 48/22c) whereas the Sheringham Extension does not overlap with any licenced blocks. The Dudgeon South Extension overlaps with two licenced blocks, 48/23a and 48/28b.

### 2.13.1.3 Telecommunication cables and interconnectors

548. The disused Stratos telecommunications cable makes landfall near Weybourne and inside the proposed Weybourne export cable corridor as it approaches the coast. From here the cable is routed in a north easterly direction, passing to the southeast of the proposed wind farm extensions (KIS-ORCA, 2019) (**Figure 2.13.1** in **Appendix 2**). There are no other telecommunications cables or interconnectors in the vicinity of the proposed development.

### 2.13.1.4 Marine aggregate extraction

549. The nearest licenced areas for aggregate production are areas 515/1 and 515/2, licenced to Westminster Gravels Ltd and located to the north and west of the proposed wind farm extensions. The nearest aggregate production area, 515/2, is 8km north of the Dudgeon North Extension. Some dredging vessels transit the proposed wind farm extensions (BMAPA, 2009), although the extensions are outside the main dredger transit routes (**Figure 2.13.1** in **Appendix 2**).

### 2.13.1.5 Disposal sites

550. There is a closed disposal site (HU147) within the Dudgeon OWF boundary. The nearest open disposal site is associated with the Race Bank OWF export cable corridor (HU126) located 10km from the Sheringham Extension (**Figure 2.13.1** in **Appendix 2**). OWF disposal sites are typically licenced for the disposal of sediment arisings from seabed levelling works, primarily during wind farm construction. There are no identified historical dumps for sewage sludge or radioactive wastes, activities that have been banned by OSPAR.

### 2.13.1.6 Unexploded Ordnance (UXO)

551. The southern North Sea has been a major area of naval and airborne warfare, most notably during World War 1 and World War 2. Consequently it is possible for UXO to be found in almost any area of the southern North Sea. There are no identified explosives dumping grounds in the vicinity of the proposed development. Magnetometer surveys have been completed across the provisional offshore export cable corridors in 2019 and further surveys will be conducted pre-construction covering DEP and SEP to identify potential UXO.

## 2.13.2 Potential Impacts

552. The Other Marine Users assessment is likely to have key inter-relationships with Marine Physical Processes, Shipping and Navigation, and Aviation and MoD. These will be considered where relevant.

### 2.13.2.1 Potential Impacts During Construction

553. In general terms, construction works such as the installation of cables or wind turbine foundations have the potential to impact on other marine users within, or adjacent to, the construction footprint. The presence of additional vessels in the area during construction may also impact other marine users.

554. **Offshore wind infrastructure:** The AfL extension areas do not overlap with any other wind farm infrastructure and therefore there is no pathway for them to interfere directly with other OWF developments. However, the proposed export cable corridor options are likely to require crossing of the existing Dudgeon export cables (**Figure 2.13.1 2n Appendix 1**). Furthermore, if the Hornsea Project Three OWF is consented, its offshore export cable corridor would cross both the proposed Weybourne and Bacton export cable route options. Where cable crossings are required, crossing agreements will be sought with cable owners and operators and appropriate installation and protection measures developed.
555. **Oil and gas infrastructure:** There is potential for interactions between existing and future oil and gas activity and the proposed projects. Equinor has sought to avoid direct conflict with existing oil and gas infrastructure through the site selection process. The extension areas are large enough to enable siting of turbines to avoid the gas pipelines that traverse them, however it may be necessary for inter-array cables to cross these pipelines. Where crossings are required for subsea cables, crossing agreements will be sought with pipeline owners and operators and appropriate installation and protection measures developed. The Dudgeon North Extension boundary is in close proximity to the normally unmanned Waveney gas platform and the potential effect of the proposed development on this and other nearby oil and gas infrastructure will be assessed, supported by engagement with the relevant operators. Any conflicts with oil and gas industry vessel and helicopter operations will be assessed as part of the Shipping and Navigation (**Section 2.8**) and Aviation and MoD (**Section 2.10**) assessments respectively, and used to inform the overall assessment of impacts on the oil and gas industry.
556. The licensing of new areas for oil and gas exploration and production, and the associated works, is ongoing and this will be monitored by Equinor. Independent Oil and Gas has approvals for installation and operation of a normally unmanned production platform, Blythe, and an additional well, Elgood, to be tied back to Blythe. Elgood and Blythe would be located adjacent to the northeastern and eastern boundaries of Dudgeon OWF respectively, connected by a pipeline around the Dudgeon OWF boundary. First gas is expected in Q2 2020 (Independent Oil and Gas (2019)).
557. Telecommunication cables and interconnectors: The Weybourne export cable corridor option may require crossing of the disused Stratos telecommunications cable. Given that the cable is disused no impact on telecommunications cables is anticipated and it is proposed to scope this impact out of the EIA.
558. Marine aggregate extraction: As there is no overlap of aggregate licence areas with the extension areas or export cable corridors, there are limited pathways for impacts upon aggregate dredging activities. It is therefore proposed to scope this impact out of the EIA. Any dredger transit conflicts will be addressed as part of the Shipping and Navigation (**Section 2.8**).
559. Disposal sites: As there is no overlap of disposal sites with the extension areas or export cable corridors there are limited pathways for impacts upon disposal sites and associated activities. It is therefore proposed to scope this impact out of the EIA.

560. **UXO:** Operations such as piling or cable installation works could result in the detonation of abandoned UXO if it were present and live. The consequences of this would depend upon the quantity of explosive and the distance of receptors from the explosion. Detailed geophysical surveys and investigations prior to construction will identify any UXO and measures will be taken to mitigate the risk, possible through clearance by controlled, remote detonation. This is a health and safety risk which will be carefully mitigated rather than being an environmental issue. It is therefore proposed that these impacts should be scoped out from further consideration within the EIA. Potential impacts from UXO clearance works will be assessed where relevant to other receptors (e.g. fish ecology, marine mammal ecology).

#### 2.13.2.2 Potential Impacts During Operation

561. The presence of permanent offshore infrastructure has the potential to impact other marine users either within, or adjacent to, the proposed extensions or export cable corridors. Any impacts of wind turbine and offshore substation structures on vessel activities, including those related to the oil and gas industry, marine aggregate extraction, recreational sailing and other OWFs will be addressed as part of the Shipping and Navigation assessment (**Section 2.8**). Potential impacts on helicopter operations associated with the oil and gas industry will be addressed as part of the Aviation and MoD assessment (**Section 2.10**). It is also recognised that the presence of the extensions may impact on potential future oil and gas exploration, appraisal and development activity.

562. Vessel movements during operation and maintenance of the wind farm extensions may also affect other users. However, impacts from operational vessel activities are anticipated to be similar to those during the construction phase, although the magnitude of effect is likely to be lower.

563. If cables require maintenance or replacement, standard industry techniques would be followed to ensure that other operators' cables and pipelines are not impacted by maintenance works. It is therefore proposed to scope this impact out of the EIA.

#### 2.13.2.3 Potential Impacts During Decommissioning

564. It is anticipated that the impacts associated with decommissioning would be similar to those during the construction phase, although the magnitude of effect is likely to be lower.

#### 2.13.2.4 Potential Cumulative Impacts

565. There is the potential for cumulative impacts with a range of other plans, projects and activities namely the existing Dudgeon and Sheringham Shoal Offshore Wind Farms, other nearby offshore wind farms at planning, construction, operation and decommissioning phases, aggregate and dredging activities, subsea cables and oil and gas activity. These will be identified and assessed in line with the approach set out in **Section 1**.

### 2.13.2.5 Potential Transboundary Impacts

566. Potential for transboundary impacts on commercial fishing and shipping will be assessed in **Section 2.7** and **Section 2.8** respectively. Transboundary impacts are largely dependent upon physical overlap and, with the possible exception of fishing and shipping, no pathways exist for transboundary impacts on other marine users beyond the footprints of the projects.

### 2.13.2.6 Summary of Potential Impacts

567. A summary of potential impacts is shown in **Table 2-31**.

*Table 2-31 Summary of impacts relating to other marine users (scoped in ✓, scoped out x)*

Potential Impacts	Construction	Operation	Decommissioning
Potential interference with other wind farms	x	x	x
Potential interference with oil and gas operations	✓	✓	✓
Potential impacts on subsea cables and pipelines	✓	✓	✓
Impacts on aggregate dredging activities	x	x	x
Impacts on disposal sites	x	x	x
Detonation of UXO	x	x	x
Cumulative impacts	✓	✓	✓
Transboundary impacts	x	x	x

### 2.13.3 Approach to Assessment and Data Gathering

568. As part of the EIA process, the existing environment with respect to other marine users will be described, including, but not limited to the following:

- Offshore wind farms infrastructure and activities;
- Oil and gas infrastructure and activities;
- Telecommunication cables and interconnectors,
- Marine aggregate sites and transit routes;
- Disposal sites; and
- UXO.

569. Equinor will undertake consultation to identify any additional areas of concern to be considered within the EIA. Identification of potential sensitive receptors will be undertaken through a desk-based assessment and in consultation with all relevant developers, operators and marine users within the vicinity of the offshore protect area to ascertain any concerns relating to the project. These will include the relevant oil and gas licence holders and operators of adjacent infrastructure, operators of the existing and planned OWF export cables for which crossing agreements would be required.



570. **Table 2-32** below identifies the desk-based sources that will be accessed to inform the characterisation of the existing environment.

*Table 2-32 Data sources to be used*

Data source	Date	Data contents
The Crown Estate - Offshore Wind Farms	2019	Planned, consented, under construction and operational wind farm areas and wind farm export cables and cable agreements. Proposed offshore wind extension projects.
Oil and Gas Authority	2019	Oil and gas surface and subsurface infrastructure, wells and pipelines.
Offshore Renewable & Cable Awareness (KIS-ORCA)	2019	Marine cables.
The Crown Estate - Marine Minerals	2019	Marine aggregates production and exploration options areas.
BMAPA - Dredger transit routes	2009	Dredger transit routes (All passage plans).
Cefas – Disposal sites	2019	GIS Shapefile of Disposal Sites.

571. The assessment will be undertaken in accordance with following standards and guidance:

- European Subsea Cables UK Association (ESCA) Guideline No 6, The Proximity of Offshore Renewable Energy Installations and Submarine Cable Infrastructure in UK Waters (ESCA, 2016);
- The International Cable Protection Committee (ICPC) has issued a series of recommendations for marine cables, specifically:
  - Recommendation No.2. Recommended Routing and Reporting Criteria for Cables in Proximity to Others (ICPC, 2015);
  - Recommendation No.3. Criteria to be Applied to Proposed Crossings Submarine Cables and/or Pipelines (ICPC, 2014); and
  - Recommendation No.13. The Proximity of Offshore Renewable Wind Energy Installations and Submarine Cable Infrastructure in National Waters (ICPC, 2013).
- Oil and Gas UK - Pipeline Crossing Agreement and Proximity Agreement Pack (Oil and Gas UK, 2015); and
- Oil and gas licencing rounds information (OGA, 2018);

572. The EIA will be based on existing data and information gathered through consultation. The EIA will focus on the Dudgeon and Sheringham Extensions and export cable corridors, and consider infrastructure or users that overlap with those boundaries. The assessment will consider agreed or best practice mitigation and be based on expert judgement.

### 3 PART 3: ONSHORE

#### 3.1 Onshore Ground Conditions and Contamination

573. The specific assessment requirements for ground conditions and contamination are set out within National Policy Statement EN-1 and are summarised in **Table A1-14** in **Appendix 1**.

##### 3.1.1 Existing Environment

###### 3.1.1.1 Geology and Hydrogeology

574. The underlying geology across the onshore ground conditions and contamination study area (the study area) is the same as onshore scoping area and is summarised below in **Table 3-1** and illustrated in **Figure 3.1.1a** in **Appendix 2** (superficial deposits) and **Figure 3.1.1b** in **Appendix 2**(bedrock geology).

575. The Environment Agency’s groundwater vulnerability maps indicate that the study area is located within an area of medium to high groundwater vulnerability. A high groundwater vulnerability designation indicates that the soil is easily able to transmit pollution to groundwater, which is characterised by high leaching potential in soils and the absence of low permeability superficial deposits. A medium groundwater vulnerability designation indicates that there are areas present which offer some groundwater protection.

576. The chalk bedrock is designated as a Principal Aquifer and a number of groundwater Source Protection Zones (SPZ) are identified within the onshore study area, with both inner and outer zones of the SPZs.

*Table 3-1 Summary of Geology and Aquifer Designations*

Stratum	Unit	Aquifer Designation
Superficial Deposits	Head – gravel, sand, silt and clay	Secondary A Aquifer
	Sheringham Cliffs Formation – clay, silt, sand and gravel	Secondary B Aquifer
	Weybourne Town Till Member – silt	Secondary Undifferentiated Aquifer
	Lowestoft Formation – sand and gravel	Secondary A Aquifer
	Alluvium – clay, silt, sand and gravel	Secondary A Aquifer
	Briton’s Lane Sand and Gravel Member – sand and gravel	Secondary A Aquifer
	River Terrace Deposits – sand and gravel	Secondary A Aquifer
	Happisburgh Glacidenic Formation and Lowestoft Formation (undifferentiated) – sand and gravel	Secondary B Aquifer
	Bacton Green Till Member – sand, silt and clay	Secondary B Aquifer
	Wroxham Crag Formation – sand and gravel	

Stratum	Unit	Aquifer Designation
Bedrock	White Chalk Subgroup	Principal Aquifer

577. There are a number of licensed groundwater abstractions within the study area which are mostly associated with agriculture. There are also likely to be a large number of private water supplies within the study area.

### 3.1.1.2 Designated Sites

578. Geological Sites of Special Scientific Interest (SSSIs) are present at both landfall search areas; Weybourne Cliffs SSSI (Weybourne landfall search area) and Mundesley Cliffs SSSI (Bacton landfall search area). Weybourne Town Pit geological SSSI, is also located in proximity to Weybourne landfall search area. Caistor St. Edmund Chalk Pit geological SSSI is located at the edge of the substation search area.

579. Information on designated sites related to ecology can be found in **Section 3.4**.

### 3.1.1.3 Land Quality

580. The study area is largely agricultural in nature, which represents potential for both diffuse and point sources of pollution to be present in relation to historical and current agricultural activities. Settlements within or adjacent to the study area including, but not limited to, Sheringham, Saxthorpe, Cawston, Easton, Hethersett, North Walsham, Marsham and Norwich also have the potential to contain historic sources of ground contamination. Several historic landfills and landfill sites have been identified within the study area (**Figure 3.1.2 in Appendix 2**), the permitted wastes at these sites include inert, industrial, commercial, household, special and liquid sludge, however, not each site was permitted to receive all waste types listed.

## 3.1.2 Potential Impacts

581. The Onshore Ground Conditions and Contamination assessment is likely to have key inter-relationships with Water Resources and Flood Risk, Land Use and Agriculture, and Ecology. These will be considered where relevant.

### 3.1.2.1 Potential Impacts During Construction

582. The following potential construction stage impacts have been identified:

- Direct impacts to the Secondary Aquifers within the superficial deposits may occur due to the intrusive nature of earthworks, trenching and drilling (if required). The significance of the disturbance will be dependent on the depth of the aquifer unit in relation to the proposed depth of the intrusive works. During construction, surface layers will be excavated allowing increased infiltration of rainwater and surface run-off to the subsurface. This could potentially mobilise any residual contamination already present in the overlying strata that could potentially migrate into the underlying shallow superficial aquifers.
- Direct impacts to the Principal Aquifers associated with the bedrock may occur from deep ground workings associated with trenchless crossings. There is the potential for drilling mud to leak along the drill path, or from the immediate area,

which could cause contamination of groundwater. Trenchless techniques also have the potential to create preferential pathways allowing potential contamination of the Principal and Secondary Aquifers.

- Direct impacts to the Principal Aquifers may also occur as a result of piling. Piling may be required to provide foundations for the onshore substation, and has the potential to create preferential pathways through the superficial deposits allowing potential contamination of the underlying Principal Aquifers.
- Excavation activities, including directional drilling, surface excavation and earth moving during cable laying and site preparation for the onshore substation and other onshore infrastructure (including piling) has the potential to mobilise existing ground contamination which could result in impacts to human health through dermal contact, inhalation and ingestion.
- There is the possibility that the hydraulic regime of the local area will be affected by the project, for example by backfilling the onshore cable trench with less compacted soil that could potentially influence the groundwater regime by altering porosity and creating preferential groundwater flow paths.
- Construction activities have the potential to result in direct impacts to Mineral Safeguarding Areas located within the proposed application boundary through prevention of future extraction of identified reserves.

583. Additional impacts to controlled waters are discussed below in **Section 3.2**.

### 3.1.2.2 Potential Impacts During Operation

584. Installation of cables along the onshore cable route and the permanent footprint of both landfall and the onshore substation infrastructure within the proposed development would prevent future extraction of resources within the permanent footprint of the project for the duration of the project's lifetime.

585. Additional significant impacts from the operation of the project are considered unlikely. Routine operation and maintenance (O&M) activities will follow standard procedures therefore minimising any potential impacts.

586. The operational easement may have the potential to result in direct impacts to Mineral Safeguarding Areas located within the proposed application boundary through prevention of future extraction of identified reserves

### 3.1.2.3 Potential Impacts During Decommissioning

587. It is anticipated that the decommissioning impacts would be similar in nature to those of construction, although the magnitude of effect is likely to be lower.

### 3.1.2.4 Potential Cumulative Impacts

588. Cumulative effects on ground conditions and contamination resulting from the effects of the proposed development and other developments will be assessed in accordance with the guidance and methodologies set out in **Section 1.6**. The assessment will be dependent on the availability and accessibility of information for other developments.

### 3.1.2.5 Summary of Potential Impacts

Table 3-2 Summary of Potential Impacts – Ground Conditions and Contamination (scoped in (✓) and scoped out (x))

Potential Impacts	Construction	Operation	Decommissioning
Impacts to human health due to: <ul style="list-style-type: none"> <li>• Disturbance and mobilisation of contaminants from existing sources;</li> <li>• Alterations to exposure pathways; and</li> <li>• Introduction of new contaminant sources.</li> </ul>	✓	x	x
Impacts to controlled waters due to: <ul style="list-style-type: none"> <li>• Disturbance and mobilisation of contaminants from existing sources;</li> <li>• Alterations to exposure pathways; and</li> <li>• Introduction of new contaminant sources.</li> </ul>	✓	x	x
Impact to geologically significant areas and designated geological sites	✓	x	✓
Cumulative impacts	✓	x	✓
Transboundary impacts	x	x	x

### 3.1.3 Approach to Assessment and Data Gathering

589. As part of the EIA process, the existing environment with respect to ground conditions and contamination will be described, including, but not limited to the following:

- Hydrology;
- Geology;
- Hydrogeology and groundwater;
- Potential contamination sources; and
- Sensitive land uses and environment.

590. The baseline for ground conditions and contamination will be established following current guidance which advocates a phased risk-based approach. A desk based Preliminary Risk Assessment (PRA) will be undertaken to establish a preliminary conceptual site model and the identification of potential pollutant linkages. The key guidance which will be used to inform the assessment will include the following:

- Defra, Environmental Protection Act 1990: Part 2A, Contaminated Land Statutory Guidance;
- Environment Agency, Model Procedures for the Management of Land Contamination, Contaminated Land Report 11 (CLR11);
- British Standard BS10175 Investigation of Potentially Contaminated Sites – Code of Practice; and
- CIRIA publication C665 Assessing risks posed by hazardous ground gases to buildings.

591. The desk-based study forms the initial step in the assessment of ground conditions and provides valuable information for the design of intrusive investigation works that may be required in the event of the PRA identifying potentially unacceptable risks associated with the ground conditions. The PRA will be progressed based on data obtained from a Landmark Envirocheck © report which incorporates historical maps, site sensitivity data, and regulatory information, and will be supplemented with information from the sources listed below in **Table 3-3**.

*Table 3-3 Data sources used*

Data source	Date	Data contents
Landmark Envirocheck	2019	Historical maps, site sensitivity data and regulatory information.
Public Health England	2019	Radon gas risk.
Environment Agency	2019	Historic landfill sites, permitted waste sites – authorized landfill site boundaries and groundwater source protection zones.
Coal Authority	2019	Closed mining sites.
British Geological Survey	2019	Solid geology, superficial geology and borehole records.
Defra	2019	SSSI, Ramsar sites, Nature Reserves, Special Areas of Conservation, groundwater vulnerability and aquifer designations – superficial and bedrock.

592. Following the identification of the proposed application boundary, further liaison with the stakeholders will be undertaken to agree the approach and methodology to data collection for EIA purposes and the specific assessment methodology. A detailed method statement will be developed and agreed with stakeholders accordingly.



## 3.2 Water Resources and Flood Risk

593. The specific assessment requirements for freshwater quality and resource are set out within National Policy Statement EN-1 and are summarised in **Table A1-15** in **Appendix 1**.

### 3.2.1 Existing Environment

#### 3.2.1.1 Surface water

##### *Surface water drainage*

594. The freshwater and quality and resource study area (the study area) is the same as onshore scoping area and encompasses three main surface water catchments (**Figure 3.2.1** in **Appendix 2**):

- The River Bure catchment: The main river rises near Briston, from where it flows in an easterly direction until it reaches Aylsham. From here, it continues to flow to the south east until it enters the sea at Great Yarmouth. Major tributaries include the River Ant, which is known for part of its length as the North Walsham and Dilham Canal. The downstream reaches of the River Bure include a wide range of wetland features, including Hoveton Great Broad and Marshes, Woodbastwick Fens and Marshes, Bure Marshes and the Norfolk Broads. The cable route search area crosses the upper River Bure and the upper River Ant sub-catchments.
- The River Wensum catchment: The river rises near Whissonsett, from where it flows north towards Fakenham before continuing in a broadly south easterly direction towards Norwich, where it flows into the River Yare. The River Wensum is a chalk river and is designated as a Special Area of Conservation (SAC) and SSSI. The cable route search area crosses the River Wensum and its tributary, the River Tud.
- The River Yare catchment: The river rises near Shipdham, from where it flows in an easterly direction towards Norwich. From here, it continues in a broadly easterly direction until it meets the sea at Great Yarmouth. Major tributaries include the Rivers Tilley, Tas and Wensum (the two rivers join downstream of the cable route search area and would be considered separately in the context of any assessment). The cable route search area crosses the River Yare and Tilley upstream of Norwich, and the onshore substation search area and National Grid infrastructure is largely located in the River Tas sub-catchment.

595. The study area, as defined by the three main drainage catchments identified above, comprises a number of surface sub-catchments, which are analogous to the Water Framework Directive (WFD) water body catchments identified by the Environment Agency in the Anglian River Basin Management Plan (RBMP) (Defra and Environment Agency, 2016) (**Figure 3.2.2** in **Appendix 2**). The main sub-catchments (and their WFD water body IDs) are listed below:

- Scarrow Beck (GB105034055740)
- Bure (u/s confluence with Scarrow Beck) (GB105034055690)
- Glaven (North Norfolk) (GB105034055780)

- Blackwater Drain (Wensum) (GB105034051120)
- Swannington Beck (GB105034051070)
- Mun (North Norfolk) (GB105034055900)
- East Ruston Stream (GB105034055670)
- North Walsham and Dilham Canal (disused) (GB105034055710)
- East Ruston Stream (GB105034055670)
- King's Beck (GB105034055730)
- Bure (Scarrow Beck to Horstead Mill) (GB105034050932)
- Mermaid Stream (GB105034050900)
- Heavingham Watercourse (GB105034050870)
- Wensum US Norwich (GB105034055881)
- Tud (GB105034051000)
- Yare (Tiffey to Wensum) (GB105034051281)
- Yare (u/s confluence with Tiffey - Lower) (GB105034051290)
- Tiffey (GB105034051282)
- Intwood Stream (GB105034051240)
- Tas (Tasburgh to R. Yare) (GB105034051230)

596. These sub-catchments are themselves divided into a large number of ordinary watercourses, including those managed by the local IDB (although these are too numerous to list at this stage).

#### *Surface water quality*

597. A review of the Environment Agency's Catchment Data Explorer WFD water quality data for the surface water bodies identified predominantly good physico-chemical and chemical water quality conditions across the main surface water catchments. However, parts of the River Bure, Wensum and Yare catchments are affected by discharges from agriculture, waste water treatment and domestic sources, which result in sub-catchments with low dissolved oxygen and elevated concentrations of nutrients (e.g. phosphates) (Environment Agency, 2016).

#### *Flood risk*

598. Environment Agency flood zone maps (Environment Agency, 2012) indicate that the majority of the study area is located within an area of low flood risk (Flood Zone 1). Flood Zone 1 is defined as land that has less than a 1 in 1,000 annual probability of river flooding (<0.1%). However, any onshore infrastructure located closer to the main rivers of the River Bure, River Wensum and River Yare and their tributaries (as identified above) have a higher risk of flooding (up to Flood Zone 3 - high risk of flooding), as identified in **Figure 3.2.3** in **Appendix 2**.

#### **3.2.1.2 Groundwater**

599. The chalk bedrock underlying the study area comprises two groundwater bodies, as defined under the WFD (**Figure 3.2.4** in **Appendix 2**):

- North Norfolk Chalk; and
- Broadland Rivers Chalk and Crag.

600. The Crag and the Chalk aquifers are classified as Principal Aquifers by the Environment Agency. The superficial deposits are classified as Secondary A, B and undifferentiated aquifers. The Environment Agency's groundwater vulnerability maps indicate the study area is located within an area of high groundwater vulnerability (overlying a permeable aquifer). This indicates soils which may be able to transmit a wide range of pollutants into any groundwater stored in the underlying strata.
601. The chalk bedrock is designated as a Principal Aquifer and a number of groundwater Source Protection Zone (SPZ) areas are identified within the study area, with both inner and outer zones of the SPZs extending across the areas covered by the study area and particularly within the substation search area. There are a number of licensed groundwater abstractions within the study area which are mostly associated with agriculture. There are also likely to be a large number of private water supplies within the study area.

### 3.2.2 Potential Impacts

602. The Water Resources and Flood Risk assessment is likely to have key inter-relationships with Onshore Ground Conditions and Contamination, Land Use and Agriculture, and Ecology. These will be considered where relevant.

#### 3.2.2.1 Potential Impacts During Construction

603. The following potential construction-stage impacts have been identified and will be assessed:
- Direct disturbance of surface water bodies: Onshore construction activities have the potential to directly alter the geomorphology, hydrology, water quality and physical habitat value of surface water bodies as a result of the installation of cabling and structures to allow temporary access across surface watercourses.
  - Increased sediment supply: Construction activities will involve earthworks and create temporary areas of bare ground by removing surface vegetation cover. These construction activities could increase the potential for the erosion of soil particulates, resulting in an increase in the supply of fine sediment (e.g. clays, silts and fine sands) to surface watercourses through surface water runoff and the erosion of exposed soils. Increased sediment supply could affect the geomorphology of the watercourse by increasing turbidity in the water column and encouraging enhanced deposition of fine sediment on the bed of the channel. Furthermore, increased sediment loads could potentially smother existing bed habitats, reduce light penetration and reduce dissolved oxygen concentration, adversely affecting stream biota (e.g. macrophytes, aquatic invertebrates and fish such as brown trout, bullhead and brook lamprey) and adversely affecting the quality of in-channel habitats. Any impacts of increased sediment supply would be particularly pronounced in chalk river catchments (such as the River Wensum and its tributaries), which naturally have low suspended sediment loads and coarse bed substrates (i.e. gravels and cobbles) with a low proportion of fine sediment.
  - Supply of contaminants: There is the potential for the accidental release of lubricants, fuels and oils from construction machinery working in and adjacent to

surface watercourses, through spillage, leakage and in-wash from vehicle storage areas after rainfall (during the main construction activities, including associated access to sites). There is also the potential for accidental release of foul waters (from welfare facilities) and construction materials (including concrete and inert drilling fluids from trenchless crossings) into the aquatic system during construction. If a significant leakage or spillage occurs, there is the potential for adverse impacts upon water quality if contaminants enter the surface drainage network or percolate into groundwater. Construction activities which disturb the ground (including excavation and piling) could therefore potentially introduce contaminants into the underlying groundwater bodies (particularly shallow aquifers). These activities could therefore adversely affect the quality of the underlying groundwater (including the Principal Aquifer and any secondary aquifers) and could potentially impact upon any licensed and unlicensed abstractions within it (including potable water abstractions protected by SPZ1 or SPZ2).

- Changes to surface water runoff and flood risk: The construction of the Projects has the potential to increase surface water runoff, which could adversely affect the hydrology and geomorphology of the surface drainage network (e.g. as a result of increased discharge resulting in bed and bank scour, and the in wash of greater volumes of fine sediment due to increased surface runoff). Furthermore, any changes in surface flows could also increase flood risk, particularly to third-party land and property in areas within Flood Zones 2 or 3.

### 3.2.2.2 Potential impacts during operation

604. The following potential operational impacts have been identified and will be assessed:

- Supply of contaminants: The operation of the Projects, including planned and unplanned maintenance, could result in the supply of fine sediment, fuels, oils and lubricants from the road network and other impermeable surfaces. This could potentially affect the geomorphology and water quality in the surface drainage network. Furthermore, there is potential for the supply of contaminants to surface waters during operation through surface runoff or accidental spillage or leakage of fuel oils or lubricants from vehicles during operational activities, which could impact upon surface water quality and that of connected groundwaters. This could have subsequent impacts upon aquatic ecology and the use of water resources for licensed and unlicensed abstractions.
- Changes to surface water runoff and flood risk: The permanent above-ground infrastructure will result in permanent changes to land use. In most cases, the change in use from existing agricultural land will create a permanent increase in impermeable area, which could result in a corresponding decrease in local infiltration and an increase in surface water runoff. Any changes to surface drainage patterns could potentially, if unmitigated, increase flood risk to third party

land and property, especially if the discharge of any drainage is not sufficiently controlled.

### 3.2.2.3 Potential Impacts During Decommissioning

605. It is anticipated that the decommissioning impacts would be similar in nature to those of construction, although the magnitude of effect is likely to be lower. The detail and scope of the decommissioning works will be determined by the relevant legislation and guidance at the time of decommissioning and agreed with the regulator.

### 3.2.2.4 Potential Cumulative Impacts

606. Onshore cumulative impacts will be considered as part of the EIA process. Any other project with the potential to result in impacts that may act cumulatively with DEP and SEP will be identified during consultation and following a review of available information. These projects would then be included in the Cumulative Impact Assessment (CIA).

607. The assessment will consider the potential for significant cumulative impacts to arise as a result of the construction, operation and decommissioning of the Projects, including the substation, cable route and National Grid infrastructure, in the context of other developments that are existing, consented or at application stage.

### 3.2.2.5 Summary of Potential Impacts

608. Potential impacts on freshwater quality and resource scoped in to the assessment are summarised in **Table 3-4**.

*Table 3-4 Summary of Potential Impacts – Freshwater Quality and Resource (scoped in (√) and scoped out (x))*

Potential Impacts	Construction	Operation	Decommissioning
Direct disturbance of surface water bodies	✓	x	✓
Increased sediment supply	✓	✓	✓
Supply of contaminants	✓	✓	✓
Changes to surface water runoff and flood risk	✓	✓	✓
Cumulative impacts	✓	✓	✓
Transboundary impacts	x	x	x

### 3.2.3 Approach to Assessment and Data Gathering

609. As part of the EIA process, the existing environment with respect to freshwater quality and resource will be described, including, but not limited to the following:

- The hydrology, geomorphology and quality of surface freshwater features, including rivers, canals, lakes and drainage ditches;
- The quality and quantity of groundwaters;
- Surface and groundwater abstractions;

- Designated sites with potential to be affected by changes to freshwater quality and resource; and
- Flood risk.

610. The assessment would be informed by a desk-based assessment and review of available data from the Environment Agency and Lead Local Flood Authority (LLFA) using the data sources identified in **Table 3-5**.

*Table 3-5 Data sources used*

Data source	Date	Data contents
Environment Agency	2019	The Catchment Data Explorer ( <a href="https://environment.data.gov.uk/catchment-planning/">https://environment.data.gov.uk/catchment-planning/</a> ) provides information on WFD River Basin Districts Management Catchments, Operational Catchments and WFD water bodies.
Environment Agency	2012	Flood Map for Planning showing the flood zones within the onshore scoping area <a href="https://flood-map-for-planning.service.gov.uk/">https://flood-map-for-planning.service.gov.uk/</a> .
Environment Agency	Undated	Habitat designations (e.g. for the River Hull Headwaters Site of Special SSSI) and species data (detailed macrophyte, invertebrate, diatom and fisheries data) for WFD water bodies.
LLFA	Undated	Historic flood incident information relating to high, surface water and/or drainage flooding.
LLFA and Environment Agency	Undated	Any previous site investigation data and public sewer records.
Department for Environment, Food and Rural Affairs (Defra)	Undated	MAGIC map ( <a href="http://www.magic.defra.gov.uk">www.magic.defra.gov.uk</a> ) showing aquifer designations, designated sites and SPZs.
Natural England	Undated	MAGIC map ( <a href="http://www.magic.defra.gov.uk">www.magic.defra.gov.uk</a> ) showing for information on designated sites and reasons for designation.
British Geological Survey (BGS)	Undated	1:50,000 geological mapping of the scoping area.

611. The surveys listed in **Table 3-6** will be undertaken during 2020 to inform the assessment. Surveys will be undertaken in accordance with established best practice methodologies and agreed in advance with stakeholders including the Environment Agency, Natural England, and the LLFA where required.



*Table 3-6 Proposed baseline surveys*

Survey/study	Timing	Spatial Coverage
Geomorphological baseline survey	Spring 2020	This would cover the areas where crossings of watercourse will need to be made, in order to characterise the existing state of the watercourse

612. Two key groups of impacts have been identified for the purposes of this assessment:

- Water resources: These include potential effects on the physical (including hydrology and geomorphology), biological or chemical character of surface waters or groundwater, potentially impacting on secondary receptors such as wetlands or abstractions, and WFD water body status; and
- Flood risk: These include potential effects of the proposed development on surface and subsurface drainage, flow conveyance and flood risk.

613. Whilst there are clear links between the two impact groups, the assessment of receptor sensitivity and the magnitude of effect may differ. Definitions of receptor sensitivity and value and impact magnitude and significance will be developed with reference to guidance for the assessment of water resources impacts provided by the Department of Transport (2015) and Highways Agency (2008).

614. The approach to assessment and data gathering will be discussed and agreed through production of a method statement and discussion with stakeholders as part of the EPP. Consultation will be undertaken at key stages throughout the EIA process. Following the identification of the proposed application boundary, further liaison with the stakeholders including the Environment Agency, Natural England, the LLFA and appropriate water companies will be undertaken to agree the approach and methodology for data collection for EIA purposes and the specific assessment methodology.

### 3.2.3.1 Supporting assessments

615. The EIA will be supported by two additional assessments:

- A FRA would be undertaken in accordance with the National Planning Policy Framework (NPPF) and following suitable guidance (e.g. MHCLG, 2014) to assess the flood risk to the development and surrounding areas. This would inform the identification of any required mitigation measures.
- A WFD Compliance Assessment will be required to assess compliance with the requirements of the WFD in line with The Water Environment (Water Framework Directive) (England and Wales) Regulations 2017. Initially this would consist of three stages (screening, scoping and detailed assessment), in accordance with the Planning Inspectorate’s guidance (PINS, 2017).

## 3.3 Land Use and Agriculture

616. The specific assessment requirements for land use and agriculture are set out within National Policy Statement EN-1 and are summarised in **Table A1-16** in **Appendix 1**.

### 3.3.1 Existing Environment

617. The existing environment will be informed by the Natural England Agricultural Land Classification (ALC) dataset. ALC grades agricultural land from Grade 1 (best quality) through to Grade 5 (poorest quality) based on factors including climate, nature of the soil and site-based factors. The predominant land use types, including ALC baseline information is shown in **Figure 3.3.1** in **Appendix 2** and networks of Public Rights of Way (PRoW), utilities and roads are illustrated in **Figure 3.3.2** in **Appendix 2** and described for the relevant search areas below.
618. The land use study area (the study area) is same as the onshore scoping area and predominantly agricultural in nature. The city of Norwich is the major urban centre for this part of Norfolk and is located to the north of the substation search area. Other urban areas include the coastal towns of Sheringham and Cromer , and also North Walsham. There is a patchwork of ‘non-agricultural’ land across the study area, which includes of areas of woodland and water bodies (e.g. rivers, lakes and ponds).
619. The Weybourne landfall search area falls within an area of ALC Grade 3 agricultural land the majority of which is under Entry Level plus Higher-Level Stewardship Schemes. The aim of Higher-Level Stewardship Schemes is for farmers to undertake environmental management schemes which offer “significant benefits” to high-priority areas. The village of Weybourne lies just to the south of the Weybourne landfall search landfall with the Norfolk Coast Path and Peddars Way National Trail running along this part of the Norfolk coast.
620. The Bacton landfall search area lies within an area of ALC Grade 1 agricultural land between Bacton Green and Mundesley; some of which is included in an Entry Level Plus Higher-Level Stewardship Scheme. The Bacton landfall search area includes the existing Bacton Gas Terminal. The Norfolk Coast Path National Trail is also present along this stretch of the Norfolk coast, along with a second PRoW which links the village of Paston to the coast.
621. The study area passes close to the current Bacton Gas Terminal and passes to the travels south and then east to meet the substation search area to the south of Norwich. Only one urban area is encountered at North Walsham within the study area.
622. The study area passes through all grades of agricultural land, but predominantly ALC Grades 2 and 3. ALC Grade 2 areas are present near Bodham, Plumstead and Cawston and Brampton and Skeyton with the remainder comprising mostly ALC Grade 3. ALC Grade 4 (moderate to poor quality agricultural land) is found in corridors alongside the River Tud and River Wensum. Large parts of the study area are under Entry Level Plus Higher-Level Stewardship Schemes with one area of Organic Entry-Level plus Higher Level Stewardship Scheme.
623. The study area includes areas of woodland and several large waterbodies including the River Wensum, the River Bure and the River Yare as well as tributaries and other smaller watercourses. A-roads which cross the study area include the A148, the A149 and A140 , the A1067, A47 and A11 as well as a numerous B-roads, PRoWs and National Cycle Routes 1, 30 and 31 are present.
624. The study area includes nine historic landfill sites.

625. The substation search area is comprised of ALC Grade 3 – good to moderate quality agricultural land with a corridor of ALC Grade 4 moderate to poor quality agricultural land surrounding the River Tas. Entry Level Plus Higher-Level Stewardship Schemes are present throughout much of substation search area.
626. The A47 heads east to west along the northern part of the substation search area, and the A140 (heading north to south) bisects the search area. There are numerous small PRowS throughout the substation search area. No large urban areas exist within the area, but the city of Norwich lies to the north and the villages of Swardeston, Mulbarton and Stoke Holy Cross lie within the search area.

### 3.3.2 Potential Impacts

627. The Land Use and Agriculture assessment is likely to have key inter-relationships with Water Resources and Flood Risk, Onshore Ground Conditions and Contamination, Ecology, and Traffic and Transport. These will be considered where relevant.

#### 3.3.2.1 Potential Impacts During Construction

##### *Agricultural Productivity*

628. There is potential for adverse impacts to soil structure and future agricultural productivity of soils impacted during construction through the use of heavy machinery and disturbance. Ground conditions and potential contamination is discussed in **Section 3.1**.

##### *Drainage*

629. There is potential for an adverse impact to the natural and artificial field drainage systems during construction works.

##### *Disruption to farming practices*

630. There is potential for adverse impacts on farming and other land use practices through the temporary loss of land availability, restricted access and disruption caused by working areas and construction traffic.

##### *Temporary closure of PRowS/cycle paths*

631. Temporary closures and alternative routes may be necessary during construction depending on the approach to crossing each of these features.

##### *Existing utilities*

632. During the construction phase, cable installation activity has the potential to impact on water, power and gas infrastructure.

##### *Public health and safety*

633. Issues relating to public health are considered in **Section 4.3**.

#### 3.3.2.2 Potential Impacts During Operation

##### *Permanent loss of land*

634. The presence of permanent infrastructure at the substation will result in the permanent loss of land including farmland, and therefore also a loss in agricultural productivity of these areas.

635. The Best and Most Versatile (BMV) agricultural land includes ALC Grades 1, 2 and 3a. The Natural England dataset for this part of Norfolk is no longer broken down into ALC Grades 3a and 3b soils. Taking a precautionary approach all ALC Grade 3 land will be assumed to fall into the ALC Grade 3a category when assessing the area of BMV potentially affected by the project.

*Disruption to farming practices*

636. There is the potential for farming practices to be restricted due to the presence of cables and access restrictions.

*Permanent closure of PRowS/cycle paths*

637. PRowS or cycle paths in the footprint of the substation have the potential to be permanently closed or redirected, however this will be avoided wherever possible through sensitive siting of onshore infrastructure.

*Public health and safety*

638. Issues of public concern and health such as Electromotive Force (EMF) arising in relation to buried cables will be considered further in **Section 4.3**.

*Drainage*

639. Permanent infrastructure and hardstanding at the substation, plus the presence of buried cables has the potential to permanently impact upon land drainage. Impacts on drainage will be considered further in **Section 3.2**.

*Soil heating*

640. Buried cable systems emit some heat, potentially causing impacts on soil characteristics and productivity. The electrical system is designed to minimise heat loss to a level which is not likely to affect crop growth.

**3.3.2.3 Potential Impacts During Decommissioning**

641. It is anticipated that the decommissioning impacts would be similar in nature to those of construction, although the magnitude of effect is likely to be lower. The detail and scope of the decommissioning works will be determined by the relevant legislation and guidance at the time of decommissioning and agreed with the regulator

**3.3.2.4 Potential Cumulative Impacts**

642. Onshore cumulative impacts will be considered as part of the EIA process. Any other project with the potential to result in impacts that may act cumulatively with DEP and SEP will be identified during consultation and following a review of available information. These projects would then be included in the Cumulative Impact Assessment (CIA).

643. The assessment will consider the potential for significant cumulative impacts to arise as a result of the construction, operation and decommissioning of the Projects, including the substation, cable route and National Grid infrastructure, in the context of other developments that are existing, consented or at application stage.

### 3.3.2.5 Summary of Potential Impacts

Table 3-7 Summary of Potential Impacts – Land Use and Agriculture (scoped in (√) and scoped out (x))

Potential Impacts	Construction	Operation	Decommissioning
Agricultural productivity	✓	✓	✓
Drainage	✓	✓	✓
Disruption to farming practices	✓	✓	✓
Temporary closure of PRow/cycle paths	✓	x	✓
Existing utilities	✓	x	✓
Permanent loss of land	x	✓	x
Permanent closure/diversion of PRow	x	✓	x
Soil heating	x	✓	x
Cumulative impacts	✓	✓	✓
Transboundary impacts	x	x	x

### 3.3.3 Approach to Assessment and Data Gathering

644. The existing environment with respect to land use and agriculture will be characterised by the following:

- Agricultural activities;
- Agricultural land classifications;
- Soil type;
- Environmental Stewardship Schemes;
- PRow and National Cycle Routes; and
- Utilities.

645. **Table 3-8** below identifies the desk-based sources that will be accessed to inform the characterisation of the existing environment.

Table 3-8 Data sources to be used

Data source	Data contents
Ordnance Survey	A-roads, railway lines and Urban areas
Norfolk County Council	Public Rights of Way
Environment Agency	Historic and current landfill sites
Natural England	Coastal paths
Natural England	Agricultural Land Classifications
National Grid	High Pressure Pipelines

Data source	Data contents
Sustrans	Regional and National Cycle Routes
Google Earth	Aerial Photography

646. Any additional data sets will be identified through ongoing consultation with stakeholders. No surveys are proposed to inform the assessment of impacts related to land use and agriculture.
647. The EIA for land use will identify the likely impacts of the Project, assess the effects and identify appropriate mitigation measures if required. The assessment will consider both direct and indirect impacts.
648. The methodology for the assessment of the effects on land use will be informed by the following current guidance:
- NE124 – Look after your land with Environmental Stewardship (Natural England, 2012);
  - Design Manual for Roads and Bridges (DMRB) Volume 11, Section 3, Part 6 (Land Use);
  - DEFRA guidance including the Construction Code of Practice for the Sustainable Use of Soils on Construction Sites (2009).

### 3.4 Ecology and Ornithology (including Sites of Nature Conservation Interest)

649. The specific assessment requirements for onshore ecology and ornithology are set out within the National Policy Statement EN-1 and are summarised in **Table A1-17** in **Appendix 1**.

#### 3.4.1 Study Area

650. The ecology and ornithology study area (the study area) is same as the onshore scoping area. In addition, European designated sites for nature conservation within 20km and nationally designated sites for nature conservation within 3km of the onshore scoping study area have been taken into account.
651. The study area has been identified for the collation of baseline data for protected species and designated sites which could be impacted as a result of the project (**Figure 3.4.1** in **Appendix 2**).
652. The onshore cable corridor, as shown on **Figure 3.4.1** in **Appendix 2**, is currently presented as a 500m wide footprint for scoping, but will be refined down to a 100m wide corridor (informed by ongoing site selection activities) for undertaking ecological surveys. Site selection will continue to be informed by the findings of the EIA and the application footprint will be based on a 45m wide corridor.



### 3.4.2 Existing Environment

653. The study area includes the coastline between Weybourne and Bacton and covers an inland area that is a predominately agricultural landscape that is interspersed with areas of arable and grazing pasture. Hedgerows are a common feature within the landscape and most commonly act as field boundaries with pockets of woodland also present. There are 15 European designated sites and 18 Sites of Special Scientific Interest (SSSI) that are located within the onshore study area (i.e. within 20km and 3km of the scoping boundary respectively), as listed in **Table 3-9**. In addition, there are numerous County Wildlife Sites throughout this part of Norfolk, which represent an important biodiversity network in addition to the nationally and internationally designated habitats.

*Table 3-9 European designated sites within 20km, and nationally designated sites within 3km, of the onshore study area*

Designated Site	Site Description	Proximity to study area
<b>European designated sites</b>		
Greater Wash SPA	Qualifying species: <ul style="list-style-type: none"> <li>• Common scoter, <i>Melanitta nigra</i></li> <li>• Common tern, <i>Sterna hirundo</i></li> <li>• Little gull, <i>Hydrocoloeus (Larus) minutus</i></li> <li>• Little tern, <i>Sterna albifrons</i></li> <li>• Red-throated diver, <i>Gavia stellata</i></li> <li>• Sandwich tern, <i>Sterna sandvicensis</i></li> </ul>	Located within study area
North Norfolk Coast Ramsar	A stretch of coastline consisting of shingle beaches, dunes, saltmarsh, intertidal mud and sand flats, brackish lagoons, reedbeds, and grazing marshes. The site supports nationally and internationally important numbers of various species of breeding or wintering waterbirds. It also includes several important botanical areas.	0.7km
The Wash and North Norfolk Coast SAC	Qualifying habitats and species: <ul style="list-style-type: none"> <li>• Sandbanks – partially covered by sea water permanently</li> <li>• Mudflats and sandflats not covered by seawater at low tide</li> <li>• Coastal lagoons</li> <li>• Large shallow inlets and bays</li> <li>• Reefs</li> <li>• <i>Salicornia</i> and other annuals colonising mud and sand</li> <li>• Atlantic salt meadows (<i>Glauco-Puccinellietalia maritimae</i>) Located within onshore study area</li> </ul>	0.7km

Designated Site	Site Description	Proximity to study area
	<p>Mediterranean and thermo-Atlantic halophilous scrubs (<i>Sarcocornetea fruticosi</i>)</p> <ul style="list-style-type: none"> <li>• Otter, <i>Lutra lutra</i></li> <li>• Harbour (common) seal, <i>Phoca vitulina</i></li> </ul>	
North Norfolk Coast SPA	<p>Qualifying species:</p> <ul style="list-style-type: none"> <li>• Avocet <i>Recurvirostra avosetta</i></li> <li>• Bittern <i>Botaurus stellaris</i></li> <li>• Common tern <i>Sterna hirundo</i></li> <li>• Dark-bellied Brent goose <i>Branta bernicla bernicla</i></li> <li>• Knot <i>Calidris canutus</i></li> <li>• Little tern <i>Sterna albifrons</i></li> <li>• Marsh Harrier <i>Circus aeruginosus</i></li> <li>• Montagu's harrier <i>Circus pygargus</i></li> <li>• Pink-footed goose <i>Anser brachyrhynchus</i></li> <li>• Sandwich tern <i>Sterna sandvicensis</i></li> <li>• Wigeon <i>Anas penelope</i></li> </ul>	1.6km
North Norfolk Coast SAC	<p>Qualifying habitats and species:</p> <ul style="list-style-type: none"> <li>• Coastal lagoons</li> <li>• Perennial vegetation of stony banks</li> <li>• Mediterranean and thermo-Atlantic halophilous scrubs <i>Sarcocornetea fruticosi</i></li> <li>• Embryonic shifting dunes</li> <li>• Shifting dunes along the shoreline with <i>Ammophila arenaria</i> ('White dunes')</li> <li>• Fixed dunes with herbaceous vegetation ('Grey dunes')</li> <li>• Humid dune slacks</li> <li>• Otter, <i>Lutra lutra</i></li> <li>• Petalwort, <i>Petalophyllum ralfsii</i></li> </ul>	0.8km
Paston Great Barn SAC	Designated as it supports the only known barbastelle maternity roost in Norfolk (1 of 3 in the UK).	Located within study area
Breydon Water Ramsar/SPA	Halvergate Marshes form the largest expanse of traditionally managed grazing/grass marshes with their intersecting system of drainage ditches, in Broadland.	18km

Designated Site	Site Description	Proximity to study area
Broadland Ramsar	Nationally and internationally important wetland complex", which is situated on fenland peats in the floodplain of the River Bure.	3.8km
North Norfolk Coast SPA	Qualifying habitats and species: <ul style="list-style-type: none"> <li>• Avocet</li> <li>• Bittern</li> <li>• Common tern</li> <li>• Dark-bellied brent goose Non-breeding</li> <li>• Knot</li> <li>• Little tern</li> <li>• Marsh harrier</li> <li>• Montagu's harrier</li> <li>• Pink-footed goose</li> <li>• Sandwich tern</li> <li>• Wigeon</li> </ul>	Located within study area
Great Yarmouth North Denes SPA	Great Yarmouth North Denes is located on the North Sea coast of Norfolk in East Anglia about 30km east of Norwich. Behind a wide shingle beach, the North Denes dune system is actively accreting. These low dunes are stabilised by marram <i>Ammophila arenaria</i> and there are extensive areas of grey hair-grass <i>Corynephorus canescens</i> . The location supports important numbers of breeding little tern that feed outside the SPA in nearby waters.	14.2km
Overstrand Cliffs SAC	Annex I habitats that is a primary reason for selection of this site is 1230 Vegetated sea cliffs of the Atlantic and Baltic Coasts	8.7km
Winterton-Horsey Dunes SAC	Annex I habitats that are a primary reason for selection of this site: <ul style="list-style-type: none"> <li>• 2150 Atlantic decalcified fixed dunes (<i>Calluno-Ulicetea</i>)</li> <li>• 2190 Humid dune slacks</li> </ul>	14.1km
Norfolk Valley Fens SAC	Annex I habitats that are a primary reason for selection of this site: <ul style="list-style-type: none"> <li>• 7230 Alkaline fens</li> </ul>	Located within study area
The Broads SAC/SPA	Annex I habitats that are a primary reason for selection of this site: <ul style="list-style-type: none"> <li>• 3140 Hard oligo-mesotrophic waters with benthic vegetation of <i>Chara spp.</i></li> </ul>	3.8km

Designated Site	Site Description	Proximity to study area
	<ul style="list-style-type: none"> <li>• 3150 Natural eutrophic lakes with <i>Magnopotamion</i> or <i>Hydrocharition</i> - type vegetation</li> <li>• 7140 Transition mires and quaking bogs</li> <li>• 7210 Calcareous fens with <i>Cladium mariscus</i> and species of the <i>Caricion davallianae</i></li> <li>• 7230 Alkaline fens               <ul style="list-style-type: none"> <li>• 91E0 Alluvial forests with <i>Alnus glutinosa</i> and <i>Fraxinus excelsior</i> (<i>Alno-Padion</i>, <i>Alnion incanae</i>, <i>Salicion albae</i>)</li> </ul> </li> </ul>	
River Wensum SAC	Designated features: <ul style="list-style-type: none"> <li>• H3260 Watercourses of plain to montane levels with <i>R. fluitantis</i></li> <li>• S1016 Desmoulin's whorl snail <i>Vertigo moulinsiana</i></li> <li>• S1092 Freshwater crayfish <i>Austropotamobius pallipes</i></li> <li>• S1096 Brook lamprey <i>Lampetra planeri</i></li> <li>• S1163 Bullhead <i>Cottus gobio</i></li> </ul>	Located within study area

**Nationally designated sites**

Swannington Ugate Common SSSI	Designated for its geology, dry acid heath and wet heath, acid valley alder woodland and water bodies.	Located within study area.
Alderford Common SSSI	Wide range of habitats developed in response to variations in soils and topography.	Located within study area.
Kelling Heath SSSI	A distinct outwash plain, providing perhaps the best example of a glacial outwash plain in England.	0.6km
Bryant's Heath, Felmingham SSSI	An area of dry acidic heathland on glacial sands.	0.6km
Eaton Chalk Pit SSSI	Consists of a series of abandoned chalk mines which are now used by various species of bat.	0.9km
Sidestrand And Trimmingham Cliffs SSSI	A mosaic of habitats which supports a broad assemblage of invertebrates.	1.8km

Designated Site	Site Description	Proximity to study area
Edgefield Little Wood SSSI	Situated on acidic glacial sands and gravels. The wood consists of the locally rare pendunculate oakwood.	1.9km
Paston Great Barn SSSI	Designated as it supports the only known barbastelle maternity roost in Norfolk (1 of 3 in the UK).	Located within study area.
Booton Common SSSI	Comprised of a mosaic of wet calcareous fen grassland and acid heath communities.	1.7km
Flordon Common SSSI	Species rich calcareous fen.	2.9km
Shotesham-Woodton Hornbeam Woods.	A group of four woodlands	2.6km
Sheringham and Beeston Regis Commons SSSI.	Acidic heathland and species-rich calcareous spring fen.	2.8km
The River Wensum SSSI	Calcareous lowland river supporting invertebrates, fish and crayfish.	Located within study area.
East Ruston Common SSSI	Large area of unimproved heathland and fen.	1.8km
Shotesham Common SSSI	Unimproved grassland, marshy grassland and wet neutral grassland.	Located within study area.
Buxton Heath SSSI	Diverse heath with fen habitat in a basin of glacial sands which a rare habitat.	2.3km
Cawston and Marsham Heaths SSSI	Form the largest area of heather-dominated heathland remaining in east Norfolk.	0.1km
Westwick Lakes SSSI	Comprised manmade lakes with unusual flora and plankton fauna.	Part of SSSI

Designated Site	Site Description	Proximity to study area
		located within study area.
Weybourne Cliffs SSSI	Colonies of sand martins in the cliff-face and fulmars on the cliff ledges.	Located within study area.

654. The area of coastline for both Weybourne landfall search area and Bacton landfall search area (see **Figure 3.4.1** in **Appendix 2**) include dune habitat between Mundesley and Bacton; and sandy cliffs to the west of Weybourne for Weybourne landfall search area. Much of the coastline for both landfall search areas is afforded protection as SSSIs for their geology, national importance and Weybourne landfall search area (Weybourne Cliffs SSSI), colonies of marine birds.
655. Approximately 1.6km to the west of the Weybourne landfall search area is The Wash and North Norfolk Coast Special Area of Conservation, North Norfolk Coast SSSI, Greater Wash Special Protection Area, North Norfolk Coast SAC and the North Norfolk Coast Ramsar. The coast is of great ornithological interest, with nationally and internationally important breeding colonies of several species. The geographical position of the North Norfolk Coast and its range of habitats make it especially valuable for migratory birds and wintering waterfowl, in particular Brent and pink-footed geese. A species of particular note is the sandwich tern; breeding colonies total up to 4,500 pairs, which represent approximately 1/12<sup>th</sup> of the world population.
656. Bird species with breeding populations of national importance include up to 1,000 pairs of common terns *Sterna hirundo*, 27 pairs (recorded in 1982) of avocets *Recurvirostra avosetta* and up to 100 pairs of bearded tits *Panurus biarmicus*. Bittern *Botaurus stellaris* and marsh harrier *Circus aeruginosus* are regular breeders in small numbers and garganey *Anas querquedula* and black-tailed godwit *Limosa limosa* also breed on occasion.
657. Migratory birds, notably waders and passerines, are often present in great abundance in the spring and autumn. Wintering birds include large numbers of brent geese *Branta bernicla* and smaller numbers of pink-footed geese *Anser brachyrhynchus* and white-fronted geese *Anser albifrons*. Ducks and waders are also present in great abundance on the marshes and intertidal areas. The shingle banks and foreshore provide suitable habitats for wintering passerines such as twite *Acanthis flavirostris*, snow buntings *Plectrophenax nivalis* and shore larks *Eremophila alpestris*.
658. These migratory and wintering birds will have ranges that may overlap with the boundary of the both landfall search areas. Both have suitable habitat for feeding and potentially breeding.



659. A review of publicly available data of the area from two similar projects (namely Hornsea Offshore Wind Farm Project Three and Norfolk Vanguard) has been undertaken to obtain an understanding of the protected species present within the wider area and with the potential to be present within the study area.

*Table 3-10 Protected species recorded within Hornsea Offshore Wind Farm Project Three and Norfolk Vanguard applications*

Species	Hornsea Offshore Wind Farm Project Three	Norfolk Vanguard
Badger <i>Meles meles</i>	✓	✓
Bats – 9 species recorded.	✓	✓
Water vole <i>Arvicola amphibius</i>	✓	✓
Otter <i>Lutra lutra</i>	✓	✓
Great crested newt <i>Triturus cristatus</i>	✓	✓
Reptiles – records of slow worm <i>Anguis fragilis</i> and grass snake <i>Natrix natrix</i>	✓ (grass snake)	✓
Wintering birds	✓	✓
Invertebrates –white clawed crayfish <i>Austropotamobius pallipes</i> have been recorded within proximity of the onshore study areas.	✓	✓
Breeding birds - Birds of Conservation Concern (BoCC) Red List or Section 41 listed species such as skylark <i>Alauda arvensis</i> , song thrush <i>Turdus philomelos</i> , dunnock <i>Prunella modularis</i> , bullfinch <i>Pyrrhula</i> , linnet <i>Linaria cannabina</i> and yellowhammer <i>Emberiza citrinella</i>	✓	✓

### 3.4.3 Potential Impacts

660. The Ecology and Ornithology assessment is likely to have key inter-relationships with Land Use and Agriculture, Water Resources and Flood Risk, Onshore Ground Conditions and Contamination, Noise and Vibration, and Air Quality. These will be considered where relevant.

#### 3.4.3.1 Potential Impacts During Construction

661. Construction activities which could affect onshore ecological receptors include: intrusive groundworks, including directional drilling, piling, and open cut trench excavation; construction of any temporary work areas or permanent above ground infrastructure; and general construction activities such as plant movement.

662. There is the potential for the loss of biodiversity through works such as excavation and construction. The impact upon biodiversity will be assessed, paying particular attention to species and habitats protected under the Habitats Directive and Birds Directive. Impacts upon sites, habitats and species protected through EU and UK law or through local policy that represent the elements of UK biodiversity most at risk of loss, isolation or degradation will be prioritised with impacts upon all habitats and species to be assessed, including demonstrating a net gain for biodiversity.
663. There is the potential for direct impacts where ecological receptors and the footprint of the proposed works overlap leading to potential loss or fragmentation of habitats and the risk of killing protected species, as well as indirect impacts where the proximity of the works may lead to a disturbance / displacement effect on protected species associated with noise, vibration, lighting, presence of workforce, disruption to groundwater, etc. In addition, invasive species present within the proposed application boundary will be considered along with the potential risk of spreading invasive species.

#### 3.4.3.2 Potential Impacts During Operation

664. The permanent above ground presence of the onshore substation and National Grid infrastructure has the potential to lead to the permanent loss of areas of ecological value or fragmentation of habitats depending on the preferred locations for development. Operational noise associated with the onshore substation and National Grid infrastructure has the potential to cause disturbance effects depending on their proximity to noise sensitive ecological receptors, particularly birds and bats. Areas above the buried cable systems would return to their previous land use and would not represent permanent loss or fragmentation of habitats.
665. During the operation phase the onshore substation will be unmanned, with only limited human presence during planned and unplanned maintenance visits. In addition, any operational lighting (other than security lighting) at the onshore substation will be limited to these infrequent maintenance visits. Operational activities would not be required along the onshore cable route other than for periodic inspections or in the event of unplanned maintenance works, although these are not considered to present a significant risk to onshore ecology.

#### 3.4.3.3 Potential Impacts During Decommissioning

666. It is anticipated that the decommissioning impacts would be similar in nature to those of construction, although the magnitude of effect is likely to be lower as mitigation would have been undertaken to minimise impacts to terrestrial ecology during construction.

### 3.4.3.4 Potential Cumulative Impacts

667. Assessment of cumulative impacts will be undertaken as part of the EIA. The approach to Cumulative Impact Assessment (CIA) will follow standard practice for assessment of onshore ecology and ornithology, considering the impacts from other developments alongside the impacts of the Project. The other developments to be considered for cumulative impact on terrestrial ecology will be identified during production of the EIA. Only projects which are reasonably well described and sufficiently advanced to provide information on which to base a meaningful and robust assessment will be included in the CIA.
668. Some impacts could also result in in-combination effects upon onshore ecology and ornithology, an assessment of which will be undertaken within the EIA.
669. The project could interact with other plans or projects to affect terrestrial ecology such as:
- Other offshore wind farm infrastructure;
  - Other energy generation infrastructure;
  - Building and / or housing developments;
  - Installation or upgrade of roads;
  - Installation or upgrade of cables and pipelines; and
  - Coastal protection works.
670. When these project impacts occur, in-combination with other developments within the area, there is the potential for the impacts to be of greater significance than when assessed individually.
671. Projects identified as having a potential cumulative impact include Norfolk Vanguard, Norfolk Boreas and Hornsea Project Three, three offshore wind projects which make landfall on the North Norfolk Coast and have onshore cables routes leading to Necton and Norwich respectively. Agreement of the projects to be taken into account as part of the CIA will be undertaken during the subsequent stages of the EIA.

### 3.4.3.5 Summary of Potential Impacts

*Table 3-11 Summary of Potential Impacts – Onshore ecology and ornithology (scoped in (✓) and scoped out (x))*

Potential Impacts	Construction	Operation	Decommissioning
Direct impacts to statutory and non-statutory designated nature conservation sites and associated qualifying features	✓	✓	✓
Indirect impacts (e.g. noise, dust, groundwater supply) to statutory and non-statutory designated nature conservation sites and associated qualifying features	✓	✓	✓
Direct impacts (permanent and temporary loss) to habitats due to the footprint of the onshore works	✓	✓	✓
Direct and indirect impacts (disturbance – noise, lighting etc / potential killing) to adjacent habitats and protected species	✓	✓	✓
Spread of invasive non-native species as a result of construction activities	✓	x	✓
Cumulative impacts	✓	✓	✓
Transboundary impacts	✓	✓	✓

### 3.4.4 Approach to Assessment and Data Gathering

672. On completion of all baseline ecological surveys, the Ecological Impact Assessment (EclA) will be undertaken following the guidance outlined in the Chartered Institute of Ecology and Environmental Management’s (CIEEM) Guidelines for Ecological Impact Assessment in the UK and Ireland: Terrestrial, Freshwater and Coastal (2018). The approach to both the EclA and data gathering (i.e. surveys) will be discussed prior to their commencement and agreed as part of the EPP. Consultation with stakeholders will be undertaken at key stages throughout the EIA and development of the project.
673. Identification of potential sensitive receptors will be undertaken using the Joint Nature Conservation Committee (JNCC) and MAGIC websites and NBIS.

*Table 3-12 Data sources that will be used to inform the assessments (to be reviewed and updated, where required, to inform the next stage of the project)*

Data source	Data contents
JNCC MAGIC website	Internationally designated nature conservation sites (i.e. Ramsar sites)
JNCC MAGIC website	European designated nature conservation sites (i.e. Special Protection Area (SPA), SAC)
JNCC MAGIC website	Nationally designated nature conservation sites (i.e. SSSI, National Nature Reserves (NNR))
JNCC MAGIC website	Local authority sites - Local Nature Reserves (LNR)
JNCC	UK Habitats of Principal Importance
Norfolk Biodiversity Information Service	Locally designated nature conservation sites (i.e. County Wildlife Sites (CWS), Local Wildlife Sites (LWS))
Norfolk Biodiversity Information Service	Protected Species records

674. Field surveys will be undertaken to define the baseline ecology and to inform the assessment of potential impacts in the relation to the confirmed locations of the onshore infrastructure. In the first instance, this will include an Extended Phase 1 Habitat Survey. The findings from the Extended Phase 1 Habitat Survey will inform the requirement and location of further species-specific surveys that will be required.
675. **Table 3-12** below identifies the desk-based sources that will be accessed to inform the characterisation of the existing environment.
676. **Table 3-13** summarises the field surveys that will be undertaken between March 2020 and October 2020 to inform the EclA. All of the field surveys will be undertaken in accordance with industry standard practice and good practice guidelines / and agreed in advance with stakeholders where required through the EPP.

*Table 3-13 Proposed Baseline Surveys*

Survey/study	Timing	Spatial Coverage
Extended Phase 1 Habitat Survey (including a check for the presence of invasive non-native species)	March – May 2020	Survey will cover the onshore cable corridor (100m for ecological surveys) plus a 50m buffer. The survey will also consider waterbodies within 250m of the onshore cable corridor and 500m of the onshore substation and National Grid infrastructure. The findings of this survey will inform the requirements for further species-specific surveys (i.e. Phase 2 surveys).
Badger surveys	March – May 2020	This survey will be undertaken concurrently with the Extended Phase 1 Habitat Survey and will record all evidence of badger activity such as setts, hairs, latrines and snuffle holes.

Survey/study	Timing	Spatial Coverage
Water vole and otter presence / absence surveys	mid-April – June 2020 (first survey visit – all waterbodies)  July – September 2020 (second survey visit – all waterbodies)	Surveys will focus on all suitable aquatic habitats which have the potential to be affected by the project.
Breeding bird surveys	April – July 2020	Surveys will concentrate on those habitats noted as supporting breeding birds which have the potential to be affected by the project.
Great crested newt presence / absence surveys	March – June 2020	eDNA surveys will be undertaken of those water bodies identified as having suitability to support breeding populations of great crested newts (within 250m of the onshore cable corridor and 500m of the onshore substation and National Grid infrastructure).
Reptile presence / absence surveys	March – September 2020	Surveys will focus on all suitable habitats that may support significant populations of reptiles which have the potential to be affected by the project.
Dormice presence / absence surveys	April – May 2020	Surveys will concentrate on all suitable woodland habitats which have the potential to be affected by the project.
Invertebrate (terrestrial and aquatic) surveys	April – May 2020	Surveys of all terrestrial and aquatic habitats which may support rare or notable invertebrates, and which have the potential to be affected by the project.
Bat activity surveys	April – October 2020	Surveys will focus on all suitable commuting / foraging habitats which may be affected by the project.
Bat emergence / re-entry surveys	May – September 2020	Surveys will focus on those features (i.e. structures / trees) that have been assessed as having medium or high potential to support roosting bats.
Botanical surveys	April – August 2020	Surveys will be undertaken of those habitats noted as containing important habitat types or which may contain rare or notable plants which have the potential to be affected by the project.



Survey/study	Timing	Spatial Coverage
Wintering bird surveys	Winter 2020/2021 if required	Surveys will cover all habitats identified as suitable for supporting wintering birds. Surveys would include observational and transect recording to understand the area's usage by wintering bird species.

677. The ecological field and assessment work will be undertaken in accordance with following standards and guidance:

- Chartered Institute of Ecology and Environmental Management (CIEEM) (2018) Guidelines for Ecological Impact Assessment in the UK and Ireland: Terrestrial, Freshwater and Coastal.
- British Standard 42020:2013 – Biodiversity. Code of Practice for planning and development;
- CIRIA Guidance note C692 Environmental Good Practice on Site Guide (3rd Edition);
- Defra Biodiversity Metric calculation tool, user guide and technical supplement (Version 2.0) (2019);
- Natural England (2015) Standing advice on protected species (bats (all species), great crested newt *Triturus cristatus*, badger, water vole *Arvicola amphibius*, otter *Lutra lutra*, reptiles, protected plants, invertebrates, white-clawed crayfish *Austropotamobius pallipes*, ancient woodlands and veteran trees);
- Bat Conservation Trust and Institute of Lighting Engineers (2018) Bats and Artificial Lighting in the UK;
- Dean et al. (2016) The Water Vole Mitigation Handbook (The Mammal Society Guidance Series);
- Edgar et al. (2010). Reptile Habitat Management Handbook;
- English Nature (2001) Great Crested Newt Mitigation Guidelines;
- Joint Nature Conservation Committee (JNCC) (2003) Herpetofauna Worker's Manual;
- Strachan and Moorhouse (2011) Water Vole Conservation Handbook, 3rd Edition; and
- GB Non-native Species Secretariat (2015) Species Information.

678. Following refinement of the study area for ecological surveys, further liaison with stakeholders will be undertaken to agree the approach and methodology to data collection for EIA purposes and the specific assessment methodology. A detailed method statement will be developed and agreed with stakeholders as part of the EPP.

### 3.5 Onshore Archaeology and Cultural Heritage

679. The specific assessment requirements for onshore archaeology and cultural heritage (historic environment) are set out within National Policy Statement EN-1 and are summarised in **Table A1-18** in **Appendix 1**.

### 3.5.1 Existing Environment

680. North Norfolk has a rich and varied history, with nationally significant archaeological remains being identified in the region alongside a built heritage resource which include some nationally and regionally significant examples of country estate manor houses with their associated parklands, as well as numerous historic ecclesiastical and vernacular buildings.
681. In order to inform this scoping exercise, a search of designated heritage assets from the National Heritage List for England (NHLE) has been carried out for the onshore archaeology and cultural heritage study area (the study area) which is the same as the onshore scoping area. The locations of designated heritage assets within the study area are illustrated on **Figure 3.5.1** and **Figure 3.5.2** in **Appendix 2**. As there are currently two options for the onshore cable corridor (see **Section 1.4**), the designated heritage assets located within each option are identified separately.
682. Within the study area there are 11 Scheduled Monuments, 226 Listed Buildings (including eight at Grade I and 32 at Grade II\*) and five Registered Parks and Gardens.
683. These designated heritage assets include some highly significant remains with archaeological interest and numerous built heritage assets. The Roman Town of *Venta Icenorum* (NHLE 1021463) is located in the north-east section of the substation search area, alongside three other Scheduled Monuments, including an Anglo-Saxon Cemetery (NHLE 1003953). Within the study area there are important designed landscapes at Sheringham Hall (NHLE 1001020) and Heydon Hall (NHLE 1000187) (both Grade II\* Registered Parks and Gardens), Barningham Hall (NHLE 1001002) (Grade II Registered), and the Scheduled Roman Settlement at Brampton (NHLE 1003698).
684. At this scoping stage, data for non-designated heritage assets from the Norfolk Historic Environment Record (NHER) has not been acquired. This would, however, be an essential requirement to inform the subsequent EIA process, PEIR and later ES (see **Section 1.6** and **Section 3.5.3**, below).
685. The region as a whole (incorporating the onshore scoping area) has high potential for archaeological remains of local, regional and national importance. For example, excavations around the outskirts of Norwich have identified a large amount of buried archaeological remains, particularly of prehistoric date, which can often be found flanking the river valleys. Archaeological excavations prior to the construction of the Norwich Southern Bypass in the 1980's (Ashwin & Bates, 2000) and the Norwich Northern Distributor Road in 2016 (Moan, 2018) revealed evidence for significant prehistoric settlement and funerary practices, as well as numerous medieval roadside settlements. Similar evidence has also been identified within the more rural localities, which the study area passes through, with cropmark evidence for probable prehistoric monuments such as round barrows being relatively commonplace within the county (*ibid.*).

### 3.5.2 Potential Impacts

686. Heritage assets may be affected by direct physical change or by change in their setting (Historic England – GPA 2, 2015b).
687. Potential impacts to heritage assets include both direct and indirect impacts, as well as changes in the setting of heritage assets, which could affect heritage significance.

688. A direct, physical impact is one where construction works directly involved with the project (e.g. excavations and groundworks) result in a direct physical change to the fabric of a heritage asset (e.g. partial or complete removal).
689. An indirect, physical, impact is one that results from the project, but not resulting from direct (planned) intervention by the project's construction (e.g. vibration from groundworks/construction traffic affecting the fabric of a heritage asset or changes in ground conditions resulting in an effect on preservation conditions beyond the project parameters).
690. Impacts to the significance of a heritage asset may also occur if a development changes the surroundings in which a heritage asset is located, experienced and appreciated (i.e. its setting). Similarly, historic character may also be affected if the proposed scheme results in a change to the prevailing character of the area.
691. The Onshore Archaeology and Cultural Heritage assessment is likely to have key inter-relationships with Traffic and Transport, and Landscape and Visual. These will be considered where relevant.

### 3.5.2.1 Potential Impacts During Construction

692. Construction activities which could affect the onshore archaeology and cultural heritage resource are: any intrusive groundworks, including directional drilling, piling, and open cut trench excavation; construction of any temporary works areas or permanent above ground infrastructure; general construction activities such as plant movement or increased traffic movements due to construction.
693. The potential impacts during construction that will be assessed are:
- Direct, physical, impacts to designated heritage assets;
  - Direct, physical, impacts to non-designated heritage assets;
  - Indirect, physical, impacts to designated heritage assets;
  - Indirect, physical, impacts to non-designated heritage assets;
  - Temporary change to the setting of designated heritage assets, which could affect their heritage significance; and
  - Temporary change to the setting of non-designated heritage assets, which could affect their heritage significance.
  - Potential Impacts During Operation
  - As the majority of the onshore project infrastructure is buried sub-surface (i.e. infrastructure associated with the buried cable systems), this element of the operational project will have limited potential to further impact the onshore archaeology and cultural heritage resource. Activity which could have an ongoing impact to the onshore archaeology and cultural heritage resource will be the presence of the onshore substation and the potential visibility of the offshore infrastructure from coastal heritage assets. Any permanent above ground infrastructure has the potential to result in a change to the setting of heritage assets, which could affect heritage significance.
  - The potential impacts during operation are:

- Permanent change to the setting of designated heritage assets, which could affect their heritage significance; and
- Permanent change to the setting of non-designated heritage assets, which could affect their heritage significance.

### 3.5.2.2 Potential Impacts During Decommissioning

694. It is anticipated that the decommissioning impacts could be similar in nature to those of construction, depending on the extent and depths to which any further intrusive sub-surface decommissioning groundworks may occur. This will be considered in more detail as the EIA process progresses.

### 3.5.2.3 Potential Cumulative Impacts

695. The project could interact cumulatively with other projects, which also have the potential for impacts associated with the onshore archaeology and cultural heritage resource. These cumulative impacts are considered primarily as:

- Direct, physical impact to the archaeological resource of the immediate and wider region; and
- Change in the setting of designated and/or non-designated heritage assets which could affect their heritage significance.

696. Where these impacts occur because of the project, in-combination with other developments within the area with similar associated impacts, there is the potential for the impacts to be of greater significance than when assessed individually.

697. Projects identified as having a potential cumulative impact include Norfolk Vanguard and Norfolk Boreas, two offshore wind farm projects which make landfall on the North Norfolk Coast, as well as the original Dudgeon and Sheringham Shoal Offshore Wind Farm Projects. Identification of further projects will be undertaken during the PEIR stage, and further consideration given at that juncture.

### 3.5.2.4 Summary of Potential Impacts

*Table 3-14 Summary of Potential Impacts – Onshore Archaeology and Cultural Heritage (scoped in (✓) and scoped out (x))*

Potential Impacts	Construction	Operation	Decommissioning
Direct, physical, impacts to designated heritage assets.	✓	x	✓
Direct, physical, impacts to non-designated heritage assets.	✓	x	✓
Indirect, physical, impacts to designated heritage assets.	✓	✓	✓
Indirect, physical, impacts to non-designated heritage assets.	✓	✓	✓
Change to the setting of designated heritage assets, which could affect their heritage significance.	✓	✓	✓
Change to the setting of non-designated heritage assets, which could affect their heritage significance.	✓	✓	✓
Cumulative impacts	✓	✓	✓
Transboundary impacts	✓	✓	✓

### 3.5.3 Approach to Assessment and Data Gathering

698. Assessment of the onshore archaeology and cultural heritage resource will be an iterative and ongoing process that will be combined with ongoing site selection work to refine the development footprint. To date, designated heritage assets, as recorded within the NHLE, have been identified within the onshore cable corridor options (500m either side of the cable option centre-line) and a 3km buffer (substation search area) around the onshore grid connection substation location.

699. The existing baseline and proposed assessment methodologies of potential impact below MHWS (including the intertidal zone) will be set out in the offshore archaeology and cultural heritage assessment (see [Section 2.9](#)).

700. The impact assessment upon the onshore archaeology and cultural heritage resource will follow a heritage significance-based approach to historic environment decision-making, as set out in the NPPF, Section 16: Conserving and enhancing the historic environment (Ministry of Housing, Communities and Local Government, 2019). The assessment will also follow all relevant and appropriate guidance as produced by Historic England (e.g. Historic England, 2015a, b and 2017).

701. As part of the EIA, a commercial search of the NHER will be undertaken, to provide the data set on previously recorded non-designated heritage assets and events. Further research will also be undertaken to inform the baseline data, including assessment of archaeological archive reports, published archaeological articles, monographs and other sources.
702. As part of the EIA process, the existing environment with respect to onshore archaeology and cultural heritage will be described, including, but not limited to the following:
- Known non-designated heritage assets within 500m of the onshore proposed application boundary;
  - Designated heritage assets within 1km of the project boundary and 5km of the onshore substation, to inform a setting assessment of heritage assets identified as potentially being affected by the development through a change in their setting.
  - Designated heritage assets along the coast which could be affected by the presence of offshore infrastructure will be included in the assessment, identified through professional judgement and consideration of a Zone of Theoretical Visibility (ZTV) developed by the LVIA consultants.
703. Identification of heritage assets potentially affected by the project will be undertaken through spatial analysis of the heritage data within a GIS framework. Initial consideration of the setting of heritage assets and any potential for impact upon heritage significance will be undertaken as part of the setting assessment, informed by walkover surveys and site visits. A full consideration of and conclusions re. setting impacts and effects will be made in the final ES, following finalisation of the project design.
704. **Table 3-15**, below identifies the sources that will be accessed to inform the characterisation of the existing environment within respect to onshore archaeology and cultural heritage.

*Table 3-15 Data sources to be used for the assessment of onshore archaeology and cultural heritage*

Data source	Data contents
British Geological Survey (BGS)	Historic borehole logs and the wider geological background for the region.
National Heritage List of England (NHLE)	Contains data on all designated heritage assets within England, maintained by Historic England. GIS data for all Scheduled Monuments, Listed Buildings, Registered Parks and Gardens and Registered Battlefields.
Norfolk Historic Environment Record (NHER)	Contains data on all recorded non-designated heritage assets, maintained by Norfolk Historic Environment Services (HES). The data includes findspots, monuments and locally listed buildings. Information on previous events (archaeological surveys and investigations) will also be obtained.



Data source	Data contents
National Record for the Historic Environment (NRHE)	Maintained by HE and contains information derived from the former National Buildings Record (NBR) and National Archaeological Record (NAR).
Walkover Surveys and Site Visits	Data from walkover surveys and site visits will be used, identifying current land-use and any potential unrecorded non-designated heritage assets.
Zone of Theoretical Visibility (ZTV) Model	Any ZTV produced by the LVIA team will be assessed to help inform settings assessment.
Existing archaeological studies and published sources	Background information on the archaeology of North Norfolk, including the results of archaeological assessments carried out for Sheringham Shoal, Dudgeon, Norfolk Boreas and Norfolk Vanguard. Archaeological monographs (E.g. East Anglian Archaeology) and unpublished archaeology archive reports will also be reviewed to inform the baseline data.

705. The following surveys (**Table 3-16**) will be undertaken in 2020 to inform the assessment. Surveys will be undertaken in accordance with industry guidelines and agreed in advance with the relevant historic environment stakeholders.

*Table 3-16 Proposed baseline surveys onshore archaeology and cultural heritage*

Survey/study	Timing	Spatial Coverage
Walkover Surveys	TBC (2020)	Targeted areas of the proposed application boundary will be visited to identify current land use and any potential unrecorded non-designated heritage assets, as well as ground truthing of certain previously recorded assets.
Setting Assessment Site Visits	TBC (2020)	Heritage assets identified as potentially being affected by the development (through a change in their setting) will be visited to inform the setting assessment.
Priority Geophysical Survey	TBC (2020)	Targeted areas for geophysical survey, identified through desk-based baseline collation, e.g. Aerial photographic and LiDAR analysis.

706. Following these initial baseline surveys, consideration of the requirement for any initial targeted archaeological evaluation (e.g. trial trenching) will be undertaken. Any targeted trial trenching may be undertaken at areas where the baseline surveys have identified a high potential for buried archaeological remains to be present. Any initial phase of targeted trial trenching would, however, be highly dependent on landowner access permissions being agreed. A more comprehensive (onshore project wide) approach to trial trenching is anticipated to take place in the post-consent stages.

707. Identification of any areas to potentially be subject to intrusive evaluation, as part of the DCO application, would be decided through consideration of the baseline data and non-intrusive surveys and would be discussed and agreed in consultation with Norfolk County Council Historic Environment Service (NCC HES).

708. The PEI / ES related assessment will be undertaken in accordance with following standards and guidance:
- Conserving and enhancing the historic environment. (Ministry of Housing, Communities & Local Government (2014, updated 2018)
  - The Historic Environment in Local Plans: Historic Environment Good Practice Advice in Planning 1 (Historic England, 2015a)
  - Managing Significance in Decision-Taking in the Historic Environment: Historic Environment Good Practice Advice in Planning 2 (Historic England, 2015b)
  - The Setting of Heritage Assets: Historic Environment Good Practice Advice in Planning 3 (Historic England, 2017)
  - Standard and guidance for historic environment desk-based assessment (ClfA, 2017)
  - Code of Conduct (ClfA, 2014b)
709. The assessment will be supported by a series of related technical reports and appendices. The identification of these report requirements is ongoing but will at least include a Desk-Based Assessment (DBA), undertaken to identify the currently recorded designated and non-designated heritage assets within defined study areas. The DBA will include assessment of cartographic sources, in respect to a historic map regression exercise of the onshore project boundary and/or targeted parts of the onshore cable corridor and substation location, to identify changes in land use throughout history and provide information on potential heritage assets.
710. Other technical reports to be produced which will inform the baseline data collection and collation, ultimately informing assessment, are:
- Aerial Photographic and LiDAR assessment.
  - Geoarchaeological desk-based review; and
  - Geophysical Survey(s).
711. A settings assessment will also be undertaken as part of the DBA, which will identify heritage assets and their associated heritage significance which could be affected by change in setting as a result of the proposed development. This will follow the Historic England five-step approach (Historic England 2017).
712. Following this scoping stage technical-level consultation with Historic England and NCC HES will begin in order to further identify and agree the primary methodologies, present initial findings and ensure potential historic environment issues are identified and considered during the EIA.

### 3.6 Air Quality

713. The specific assessment requirements for air quality are set out within National Policy Statement EN-1 and are summarised in **Table A1-19** in **Appendix 1**.

### 3.6.1 Existing Environment

714. The existing environment in the air quality study area (the study area) is same as the onshore scoping area and largely rural in nature with the principal source of pollutants in the area likely to be from road traffic. There are no statutory Air Quality Management Areas (AQMAs) designated within the study area; as such, existing air quality is considered to be good.

715. Receptors sensitive to changes in air quality include human receptors within 350m of dust-generating construction works and within 200m of roads along which project-generated traffic may travel. Designated ecological sites within 50m of construction works and 200m of the road network may also be affected.

### 3.6.2 Potential Impacts

716. The Air Quality assessment is likely to have key inter-relationships with Traffic and Transport, Ecology, and Health. These will be considered where relevant.

#### 3.6.2.1 Potential Impacts During Construction

717. Impacts during construction may occur at human and ecological receptors as a result of the following:

- The generation of dust and particulate matter during onshore construction works (e.g. earthworks, soil stockpiles etc.);
- Increases in emissions from road vehicles generated during construction which will contribute to existing pollutant concentrations at human receptors and deposition levels at designated ecological sites.

#### 3.6.2.2 Potential Impacts During Operation

718. Operation of the proposed built infrastructure will not give rise to any emissions to air, and maintenance activities will not lead to a significant change in vehicle flows within the study area. On this basis the potential air quality impacts during the operational phase of the development are anticipated to be negligible. It is therefore proposed to scope operational phase air quality out of the ES.

#### 3.6.2.3 Potential Impacts During Decommissioning

719. It is anticipated that the decommissioning impacts would be similar in nature to those of construction, although the magnitude of effect is likely to be lower. The detail and scope of the decommissioning works will be determined by the relevant legislation and guidance at the time of decommissioning and agreed with the regulator.

#### 3.6.2.4 Potential Cumulative Impacts

720. Onshore cumulative impacts will be considered as part of the EIA process. Any other project with the potential to result in impacts that may act cumulatively with DEP and SEP will be identified during consultation and following a review of available information. These projects would then be included in the CIA.

721. The assessment will consider the potential for significant cumulative impacts to arise as a result of the construction, operation and decommissioning of the Projects, including the substation, cable route and National Grid infrastructure, in the context of other developments that are existing, consented or at application stage.

### 3.6.2.5 Summary of Potential Impacts

722. Potential impacts on air quality scoped in to the assessment are summarised in **Table 3-17**.

*Table 3-17 Summary of impacts relating to air quality (scoped in (✓) and scoped out (x))*

Potential Impacts	Construction	Operation	Decommissioning
Generation of dust and particulate matter affecting human and ecological receptors	✓	x	✓
Increases in road traffic emissions affecting human and ecological receptors	✓	x	✓
Cumulative impacts	✓	x	✓
Transboundary impacts	x	x	x

### 3.6.3 Approach to Assessment and Data Gathering

723. As part of the EIA process, the existing environment with respect to air quality will be described, including, but not limited to the following:

- Identification of any AQMAs along routes which project-generated vehicles may travel;
- Baseline pollutant concentrations at identified human receptors; and
- Baseline deposition and pollutant concentrations at designated ecological sites.

724. Identification of potential sensitive receptors will be undertaken using Ordnance Survey mapping data and the Defra MAGIC map database. No field surveys are proposed to inform the characterisation of the existing environment.

725. **Table 3-18** below identifies the desk-based sources that will be accessed to inform the characterisation of the existing environment.

*Table 3-18 Data sources used*

Data source	Date	Data contents
Local Authority Air Quality Annual Status Reports	2019 or latest available	Air quality monitoring data collected by the Local Authorities within the air quality study area
Centre for Ecology and Hydrology Air Pollution Information System	2019	Critical Loads and Levels for designated ecological sites

Data source	Date	Data contents
Defra 1km x 1km background pollution mapping	2019	2017-based background pollutant mapping data

726. The assessment will be undertaken in accordance with following standards and guidance:

- Institute of Air Quality Management (IAQM) (2014) Guidance on the Assessment of Dust from Demolition and Construction;
- IAQM and Environmental Protection UK (EPUK) (2017) Land-Use Planning and Development Control: Planning for Air Quality;
- IAQM (2019) A Guide to the Assessment of Air Quality Impacts on Designated Nature Conservation Sites;
- Highways Agency (now Highways England) (2007) Design Manual for Roads and Bridges HA207/07 Air Quality; and
- Defra (2016) Local Air Quality Management Technical Guidance LAQM.TG(16).

727. A qualitative assessment of the potential for dust generation as a result of the construction of the project will be undertaken in accordance with IAQM guidance (IAQM, 2014). The risk of dust impacts as a result of construction activities will be determined, and mitigation measures will be recommended which are commensurate with the identified risk, to ensure impacts are not significant.

728. The increase in traffic flows generated by the project will be screened using criteria in IAQM and EPUK (IAQM and EPUK, 2017) and DMRB guidance (Highways Agency, 2007). Where traffic flows exceed the screening criteria and there are relevant receptors located within 200m of the road, a detailed dispersion modelling assessment will be undertaken to consider impacts at these locations. Concentrations of nitrogen dioxide (NO<sub>2</sub>) and particulate matter (PM<sub>10</sub> and PM<sub>2.5</sub>) will be predicted at human receptors, and concentrations of NO<sub>x</sub> and associated nutrient nitrogen and/or acid deposition will be calculated at ecological receptors. The significance of effects will be determined in accordance with IAQM and EPUK guidance (IAQM and EPUK, 2017).

729. Following the identification of the proposed application boundary, further liaison with the relevant stakeholders (including local authorities and Natural England) will be undertaken to agree the approach and methodology to data collection for EIA purposes and the specific assessment methodology. A detailed method statement will be developed and agreed with stakeholders as part of this exercise.

### 3.7 Noise and Vibration

730. The specific assessment requirements for noise and vibration, as detailed in the NPSs, are summarised in **Table A1-20** in **Appendix 1**.

#### 3.7.1 Existing Environment

731. The noise and vibration study area (the study area) is same as the onshore scoping area.

732. The landfall search areas are predominantly rural with small villages and isolated residential properties which are likely to experience low ambient noise levels presently. Weybourne landfall search area is located on the North Norfolk Coast near Weybourne. The Bacton landfall search area is located between Bacton and Mundesley.
733. The main noise sources at the landfall search areas are likely to be local roads and trains using the Cromer to Holt (passing through Sheringham) railway line, and Weybourne Airfield (Weybourne landfall search area); and local roads and the industrial area at the Bacton Gas Terminal (Bacton landfall search area).
734. The cable route search area is also predominantly rural in nature. The largest settlements within the area are at North Walsham, Sheringham, Hethersett, Wymondham, Aylsham, Thorpe Marriott and Taverham. The main noise sources within the cable route search area are likely to be:
- The A47 and the A1067 roads in the central section of the project search area;
  - The A140 and the A149 roads in the east of the area;
  - The A47 Norwich Southern Bypass, The Norwich Northern Distributor Route, and A11 Hethersett Bypass;
  - The Norwich to Holt railway line in the east of the area:
  - Industrial areas at North Walsham, Wymondham and Hethersett; and
  - Felthorpe Airfield and Norwich International Airport.
735. The substation search area is located in proximity to the existing Norwich Main substation. The nearest settlements (and therefore potential the most sensitive receptors) are Dunston to the east, Swardeston to the west, Mulbarton to the south-west and Swainsthorpe to the south.
736. Background noise within the substation search area is likely to be dominated by road traffic on the A47 (Norwich Southern Bypass), Ipswich Road Interchange, and the A140; trains using the Great Eastern Main Line, and operational substations associated with Norwich Main. The area is generally rural in nature with the village of Mulbarton (to the south-west) containing the largest concentration of residential properties. Smaller villages and isolated residential properties are also located within and around the search area.

### 3.7.2 Potential Impacts

737. The Noise and Vibration assessment is likely to have key inter-relationships with Traffic and Transport, Ecology, and Health. These will be considered where relevant.

#### 3.7.2.1 Potential Impacts During Construction

738. Cable installation activities will include directional drilling, surface excavation and earth moving. Excavation and earth moving will also be undertaken as part of the site preparation for the substation and other onshore infrastructure.
739. There is also the potential for piling of foundations for the substation and for National Grid infrastructure, and (if necessary) to provide a stable temporary platform for the drilling rigs at the landfall and along the onshore cable route associated with trenchless crossings.



740. There may be a potential requirement for evening and night time working for some activities which are often required to be continuous from start to completion, such as concrete pouring and trenchless crossings (including the landfall works). These temporary works activities have the potential to impact the closest noise sensitive receptors.

741. In summary, the potential temporary impacts of construction noise may arise from:

- Piling if required at the substation or at trenchless crossings;
- The proximity of the proposed activities to noise sensitive premises (including residential properties) and noise sensitive areas including Public Rights of Way (PRoW), , the Norfolk Broads National Park, Norfolk Coast Area of Outstanding Natural Beauty (AONB) at the Norfolk Coast, and sites designated for nature conservation;
- Proximity of works to significant designated heritage sites and monuments;
- Activities carried out on the surface along the proposed cable corridor (mainly earth moving and excavation);
- Construction activities at the substation and national grid sites including concrete pouring and any potential landscaping works i.e. fencing, construction of earth berms;
- Directional drilling activities, including at the landfall;
- Temporary increases in light and heavy goods vehicles associated with delivering and removing materials (including spoil and fill) and plant; and
- Vibration where piling, drilling and trenchless crossing works are required.

### 3.7.2.2 Potential Impacts During Operation

742. Potential operational noise impacts will be limited to the operation of the onshore substation and National Grid infrastructure and the proximity of noise sensitive receptors to the permanent above ground electrical infrastructure. Operational noise impacts may arise from the operation of equipment within the onshore substation (e.g. reactors, filters, and transformers). Potential operational noise impacts may arise from:

- The inherent operational noise from the proposed development, and any associated characteristics (tonality, intermittency, impulsivity, other acoustic characteristics);
- The proximity of the proposed development to noise sensitive premises (including residential properties) and noise sensitive areas;
- The proximity of the proposed development to quiet places and other areas that are particularly valued for their acoustic environment or landscape quality;
- The proximity of the proposed development to designated sites where noise may have an adverse impact on protected species or other wildlife; and
- Onshore substation and infrastructure maintenance activities.

743. There are unlikely to be any noise and vibration impacts relating to operational or maintenance vehicular traffic as the site will be unmanned with only periodic maintenance visits. As such, it is proposed that operational noise impacts from traffic are scoped out of further assessment.

744. Operational onshore project substation plant such as transformers and other sound power equipment vibration effects are considered negligible as industry standard requires the use of vibration isolation pads/mounts to prevent transmission of ground borne vibration. The proposed onshore project substation will be designed to achieve negligible levels of ground-borne vibration.
745. Therefore, it is considered there will be no significant sources of vibration associated with the operational substation and operational vibration impacts have therefore been scoped out of further assessment.

### 3.7.2.3 Potential Offshore Airborne Noise Impacts During Construction and Operation

746. Underwater noise disturbance to biological receptors is considered within the relevant sections for those offshore receptors.
747. Airborne noise offshore is likely to be generated by a mix of natural and anthropogenic sources. Vessel movements are expected to be the main source of anthropogenic noise within the site. Wind, wave and precipitation activity offshore would be the primary sources of natural airborne noise.
748. During the construction phase, increased vessel activity and device installation have the potential to increase airborne noise within the offshore scoping area. At locations in closer proximity to the shoreline, construction activities that will generate airborne noise will be limited to installation of the export cable, which may require trenching, ploughing or jetting the cable. In general, noise generated by cable laying vessels is generally low and is unlikely to be significantly elevated above background levels. Furthermore, vessel-based works inshore will also be short in duration.
749. During decommissioning, there is the potential for some offshore decommissioning activities to create airborne noise, although it is expected that this would be lower than during the construction phase.
750. Given the distance between the proposed offshore wind farm arrays and the coast (15.9km - SEP; and 27km – DEP) at their closest points) operational turbine noise will not be audible to onshore receptors.
751. Due to the limited pathway for offshore airborne noise to onshore noise sensitive receptors it is proposed that offshore airborne noise is scoped out of the EIA.

### 3.7.2.4 Potential Impacts During Decommissioning

752. It is anticipated that the decommissioning impacts would be similar in nature to those of construction, although the magnitude of effect is likely to be lower. The detail and scope of the decommissioning works will be determined by the relevant legislation and guidance at the time of decommissioning and agreed with the regulator.

### 3.7.2.5 Potential Cumulative Impacts

753. Onshore cumulative impacts will be considered as part of the EIA process. Any other project with the potential to result in impacts that may act cumulatively with DEP and SEP will be identified during consultation and following a review of available information. These projects would then be included in the Cumulative Impact Assessment (CIA).

754. The assessment will consider the potential for significant cumulative impacts to arise as a result of the construction, operation and decommissioning of the Projects, including the substation, cable route and National Grid infrastructure, in the context of other developments that are existing, consented or at application stage.

### 3.7.2.6 Summary of Potential Impacts

755. A summary of the potential noise and vibration impacts during the construction, operation and decommissioning phases are detailed in **Table 3-19**.

*Table 3-19 Summary of Potential Impacts – Noise and Vibration (scoped in (✓) and scoped out (x))*

Potential Impacts	Construction	Operation	Decommissioning
Noise affecting human and ecological receptors	✓	✓	✓
Vibration affecting human and ecological receptors	✓	x	✓
Cumulative impacts	✓	✓	✓
Transboundary impacts	x	x	x

### 3.7.3 Approach to Assessment and Data Gathering

756. Noise and vibration associated with the onshore Project construction works would be assessed using the guidance contained in BS 5228:2009+A1:2014, which defines the accepted prediction methods and source data for various construction plant and activities.

757. Construction noise impacts would be based on the likely construction program and associated activities, including cable installation, earthworks and directional drilling works. Noise impacts associated with peak construction traffic and identified access routes will also be undertaken.

758. The spatial scope of the construction noise assessment would include the following geographic coverage:

- Onshore scoping area where activities could affect noise sensitive receptors; and
- Traffic routes subject to significant changes in traffic flows (and/or percentage HGV) associated with the construction of the project.

759. Operational impacts would include noise impacts associated with the onshore substation and National Grid infrastructure. The guidance and methodology contained in BS 4142:2014+A1:2019 would be used to assess noise impacts arising from the onshore substation and National Grid infrastructure.

760. Following further refinement of the study area during site selection process and identification of the proposed application boundary, further liaison will be undertaken with the relevant stakeholders North Norfolk District Council (NNDC), Broadland District Council (BDC), South Norfolk Council (SNC), and Norwich City Council (NorCC) to agree the approach to data collection and the assessment methodology. A detailed method statement will be developed and agreed with these stakeholders.

761. Identification of potential noise sensitive receptors for the purposes of the characterisation of the existing environment will be undertaken using the data sources detailed in **Table 3-20**.

*Table 3-20 Data sources used*

Data source	Date	Data contents
Google Maps Aerial Photography	2017	Location of noise sources and sensitive receptors with the onshore noise and vibration scoping area
Environment Agency LIDAR Data	2018	Topographical data
Ordnance Survey Maps	2019	Vector map

762. Details of the proposed baseline survey are shown in **Table 3-21**. The survey will be undertaken in accordance with BS7445 and BS4142:2014+A1:2019 guidelines and agreed in advance with NNDC, BDC, SNC, and NorCC where required.

*Table 3-21 Proposed baseline surveys*

Survey/study	Timing	Spatial Coverage
Baseline noise survey at agreed nearest noise sensitive receptors	Q2 2020	Onshore noise and vibration study area – landfall, onshore cable corridor, onshore substation
		Shorter term (daily), baseline sound surveys along the route of the cable corridor consisting of daytime and night-time attended noise measurements at locations representative of sensitive receptors;
		Longer term (up to a week) baseline sound surveys in the area of the onshore substation and infrastructure consisting of unattended, continuous noise measurements at locations representative of agreed sensitive receptors.

763. The assessment will be undertaken in accordance with following standards and guidance:

- British Standard (BS) 4142:2014+A1:2019 – Method for Rating and Assessing Industrial and Commercial Sound;
- BS 5228-1:2009+A1:2014 Code of Practice for Noise and Vibration Control on Construction and Open Sites – Part 1: Noise;
- BS 5228-1:2009+A1:2014 Code of Practice for Noise and Vibration Control on Construction and Open Sites – Part 2: Vibration;
- BS 8233:2014 Guidance on Sound Insulation and Noise Reduction for Buildings;
- BS 7445-1:2003 Description and measurement of environmental noise. Guide to quantities and procedures;
- BS 7445-2:1991 Description and measurement of environmental noise. Guide to the acquisition of data pertinent to land use;
- BS 6472-1:2008 Guide to Evaluation of Human Exposure to Vibration in Buildings;
- Calculation of Road Traffic Noise (CRTN) 1988;

- Design Manual for Roads and Bridges (DMRB), 2011;
- World Health Organization (1999) Guidelines for Community Noise;
- World Health Organization (2009) Night Noise Guidelines for Europe; and
- World Health Organization (2018) Environmental Noise Guidelines for the European Region.

### 3.8 Traffic and Transport

764. The specific assessment requirements for Traffic and Transport are set out within National Policy Statement EN-1 and EN-3 and are summarised in **Table A1-21** in **Appendix 1**.

#### 3.8.1 Existing Environment

765. Norfolk has one of the largest highway networks in the country with over 6,000 miles of roads. The construction access strategy will seek to direct the majority of Heavy Goods Vehicle (HGV) movements via the 'A' road network. Within the scoping area, the principal highway network (managed by Norfolk County Council Highways) includes the A148, A149, A140, A1067, whilst the A47 forms part of the strategic network managed by Highways England. The main A roads within the traffic and transport study area (the study area) are depicted within **Figure 3.8.1** in **Appendix 2**.
766. The A47 is identified in the Norfolk County Council Local Transport Plan (LTP) as one of Norfolk's key strategic connections, forming part of the Trans-European Transport Network, providing the main east-west road connection and route to the Midlands and north of England. Local to the scoping area the A47 provides a key link between Norwich to the south and King's Lynn and then Peterborough to the west.
767. The A47 is predominately single carriageway road, however around the major urban areas (Norwich, Dereham, Swaffham and King's Lynn) the road widens to dual carriageway. Highways England have identified a number of schemes along the A47 to address congestion hotspots; these works are programmed to commence construction in 2020 and include the proposed widening the A47 to dual carriageway between North Tuddenham and Easton.
768. The A148 routes north to Cromer as a single carriageway road to a junction with the A140. The A140 continues south as predominately single carriageway to Norwich carrying in the region of 12,179 vehicles per day.
769. The A149 routes west from Cromer to Hunstanton as a single carriageway road. Then the A149 continues south to Norwich carrying in the region of 3,282 vehicles per day.
770. The A140 has a priority junction with the A149. The A140 is a predominantly rural single carriageway that runs south towards Norwich carrying in the region of 11,725 vehicles per day of which 4.5% are HGVs.
771. The A1067 routes generally west to east between Fakenham and Norwich. The A140 is a rural single carriageway carrying in the region of 9,140 vehicles per day of which 5% are HGVs.
772. The Norwich Northern Distributor Road (recently renamed to the A1270 - Broadland Northway) was fully opened to traffic in May 2018. The road links Norwich Airport and can act as relief for A47 congestion on the A47 and local roads by providing an amenable route around the city centre.



773. The Norfolk County Council LTP (2011) raises concerns with regard to road safety, noting that: “Road safety continues to be a major public concern and is reflected in our conversations with residents.”

774. A review of the collision rates published within Department for Transport (2017) shows that the rate of people killed or seriously injured (per billion vehicles miles) in Norfolk is 429. This rate is slightly lower than the average for the East of England (436) and lower than that for England as a whole (550).

### 3.8.2 Potential Impacts

775. The Traffic and Transport assessment is likely to have key inter-relationships with Land Use and Agriculture, Noise and Vibration, Air Quality and Health. These will be considered where relevant.

#### 3.8.2.1 Potential Impacts During Construction

776. The onshore construction phase will require the import of materials and plant to the onshore work areas. At this stage, the likely material quantities and workforce numbers have not yet been determined, however, it is envisaged that daily traffic demand is likely to be significant with a large component being HGV deliveries and the potential requirement for abnormal loads to consider.

777. [Table 3-22](#) sets out the potential construction traffic impacts and the likely user groups affected.

*Table 3-22 Potential impact of traffic assessment*

Potential Impact of traffic	Affected user groups
<b>Driver delay</b>	Commuters, tourists and business users
<b>Severance</b>	Local communities and tourists in the area
<b>Pedestrian/cycle amenity</b>	Local communities and tourists in the area
<b>Road safety</b>	Commuters, tourists, business users and local community
<b>Abnormal loads</b>	Commuters, tourists and business users

778. Traffic borne impacts upon air quality and noise and vibration are considered separately in [Section 3.6](#) and [Section 3.7](#).

779. The preferred base port (or ports) for the offshore construction of the proposed DEP and SEP is not known and any decision would not be expected until post-consent. Such facilities would be provided or brought into operation by means of one or more planning applications or as port operations with permitted development rights. It is therefore proposed to scope out at the assessment the onshore impacts of the traffic and transport impacts associated with offshore construction activities.

#### 3.8.2.2 Potential Impacts During Operation

780. The onshore substation will not be permanently manned; however, staff will periodically visit to carry out routine checks and maintenance. Most annual maintenance will be short, but if necessary some campaigns may be longer.



- 781. Any inspections/maintenance of the cable route will be infrequent and subject to very low vehicle demand.
- 782. Similar to this construction phase no decision has been made on a preferred base port for the offshore operation and maintenance of DEP and SEP. Therefore, it is proposed to scope out of the assessment the onshore traffic and transport impacts of offshore operation and maintenance activity
- 783. A separate planning exercise will be undertaken to consider traffic and transport impacts in context with any permitted development rights established at the selected site(s).
- 784. It is therefore proposed to scope out the operational traffic and transport effects from the EIA.

### 3.8.2.3 Potential Impacts During Decommissioning

- 785. It is anticipated that the decommissioning impacts would be similar in nature to those of construction, although the magnitude of effect is likely to be lower.

### 3.8.2.4 Potential Cumulative Impacts

- 786. Onshore cumulative impacts will be considered as part of the EIA process. Any other project with the potential to result in impacts that may act cumulatively with DEP and SEP will be identified.
- 787. Consultation with the highway authorities (Norfolk County Council and Highways England) will seek to identify any significant developments that could have a cumulative impact with the construction phase of DEP and SEP (e.g. the widening of the A47, other Nationally Significant Infrastructure projects, large residential development over 100 homes etc.
- 788. The assessment would consider the potential for significant cumulative impacts to arise because of the construction of the project in the context of other developments that are existing, consented or at application stage.

### 3.8.2.5 Summary of Potential Impacts

- 789. **Table 3-23** below highlights the potential impacts and user group impacts that will be scoped in and out during each phase of DEP and SEP.

*Table 3-23 Summary of Potential Impacts – Traffic and Transport (scoped in (✓) and scoped out (x))*

Potential Impact	Construction	Operation	Decommissioning
Driver Delay	✓	x	✓
Severance	✓	x	✓
Pedestrian/Cycle amenity	✓	x	✓
Road safety	✓	x	✓
Abnormal loads	✓	x	✓
Onshore traffic associated with the offshore construction	x	x	x
Cumulative impacts	✓	x	✓
Transboundary impacts	x	x	x

### 3.8.3 Approach to Assessment and Data Gathering

790. The principal guidelines for the assessment of the environmental impacts of road traffic associated with new developments are the ‘Guidelines for the Environmental Assessment of Road Traffic’ (GEART) published by the Institute of Environmental Assessment in January 1993. The guidance provides a framework for the assessment of traffic borne environmental impacts, such as pedestrian severance and amenity, driver delay, accidents and safety; and noise, vibration and air quality.

791. GEART suggests the following rules to define the extent and scale of the assessment required:

- Rule 1: Include highway links where traffic flows are predicted to increase by more than 30% (or where the number of HGVs is predicted to increase by more than 30%).
- Rule 2: Include any other specifically sensitive areas where traffic flows, or the number of HGVs are predicted to increase by 10% or more.

792. The above criterion applied to the proposed DEP and SEP’ traffic demand will dictate the extent of the study area and the scale of the impact assessment.

793. In addition to GEART, the Design Manual for Roads and Bridges (DMRB) published by Highways England provides standards and documentation relating to the design, assessment and maintenance of trunk roads in the United Kingdom. Whilst the DMRB has been prepared for trunk roads and motorways, it is proposed that DMRB is adopted as best practice within any assessment for the design of accesses, and to augment the GEART assessment of severance and amenity impacts.

794. Traffic demand will be derived by way of a ‘first principles’ approach whereby traffic generation is calculated from an understanding of likely material demand and resourcing requirements. These numbers will be informed by industry experts, drawing on their experience of delivering and operating offshore wind farm projects.

795. The DEP and SEP' traffic demand will then be assigned to the highway links within the study area and the increase in traffic flow to baseline conditions determined. The magnitude of effect associated with these increases will be determined to inform the impact assessment.

796. The **Table 3-24** highlights the magnitude of effects and the threshold levels that have been adapted from GEART.

*Table 3-24 Magnitude of effects thresholds*

Effect	Very low	Low	Medium	High
Highway Safety	Informed by a review of existing collision patterns and rates based upon the existing personal injury collision records and the forecast increase in traffic			
Driver delay	Informed by projected traffic increases through sensitive junctions			
Pedestrian amenity	Change in traffic flow (or HGV component) less than 100%		Greater than 100% increase in traffic (or HGV component) and a review based upon the quantum of vehicles, vehicle speed and pedestrian footfall.	
Severance	Change in total traffic flow of less than 30%	Change in total traffic flows of 30-60%	Change in total traffic flows of 60-90%	Changes in total traffic flows of over 90%

797. The magnitude of effect would then be combined with the sensitivity of each discrete highway link within the transport study area to determine the overall impact of DEP and SEP traffic. The link sensitivity would be determined by the concentration of sensitive receptors served by that link. **Table 3-25** provides broad definitions of the different sensitivity levels which are to be applied to the assessment.

*Table 3-25 Sensitive Receptors*

Sensitivity	Definition
<b>Low</b>	Sensitive receptors and / or highway environment can accommodate changes in volumes of traffic
<b>Medium</b>	A low concentration of sensitive receptors (e.g. residential dwellings, pedestrian desire lines, etc.) and limited separation from traffic provided by the highway environment
<b>High</b>	High concentrations of sensitive receptors (e.g. hospitals, schools, areas with high tourist footfall etc.) and limited separation provided by the highway environment
<b>Negligible</b>	Routes of no material influence to the assessment not included in the traffic and transport study area.

798. All proposed delivery routes will be assessed for their suitability to accommodate forecast HGV traffic and abnormal loads.

799. As details of the proposed traffic demand become known a detailed method statement will be prepared and submitted to the highway authorities (Norfolk County Council and Highways England) to confirm the traffic impact assessment methodology.

800. **Table 3-26** below identifies the desk-based sources that will be accessed to inform the characterisation of the existing environment.

*Table 3-26 Data sources used*

Data source	Date	Data contents
Department for Transport Traffic Counts	Latest year available	Baseline annual average daily traffic flows for all road and A roads.
Online Mapping	n/a	Details of existing highway baseline including sensitive receptors, walking and cycling routes.
Norfolk County Council Collision Data	Latest five-year period available	Personal injury collision data for all links within the study area
NSIP Planning Applications	n/a	Relevant baseline data from recent submissions including - Norfolk Vanguard Offshore Wind Farm, Norfolk Boreas Offshore Wind Farm and Hornsea Project Three Offshore Wind Farm.

801. The following surveys / studies will be undertaken to inform the assessment. Surveys will be undertaken in accordance with relevant guidelines and agreed in advance with stakeholders.

802. **Table 3-27** highlights the proposed baseline surveys that will be undertaken to inform the assessment.

*Table 3-27 Proposed baseline surveys*

Survey/study	Timing	Spatial Coverage
Traffic Counts	Latest year available	Baseline annual average daily traffic flows for all road and A roads.

## 4 PART 4: WIDER SCHEME ASPECTS

### 4.1 Seascape, Landscape and Visual

803. A Seascape, Landscape and Visual Impact Assessment (SLVIA) will be undertaken to identify the likely significant effects of the proposed DEP and SEP on seascape, landscape and visual amenity.

804. The specific assessment requirements for seascape, landscape and visual are set out within National Policy Statements EN-1 and EN-3, as summarised in **Table A1-22** in **Appendix 1**.

#### 4.1.1 Existing Environment

##### 4.1.1.1 Seascape and landscape character

805. Seascape is defined by Natural England (2010) as: “An area of sea, coastline and land, as perceived by people, whose character results from the actions and interactions of land with sea, by natural and / or human factors.” A Seascape Character Area (SCA) assessment for the East Inshore and East Offshore marine plan areas (MMO 2012) covers the areas that DEP and SEP would be located. The wind farm sites are located within the East Midlands Offshore Gas Fields (SCA 03), East Midlands Shipping Waters (SCA 07), and Norfolk Coastal Waters (SCA 09). These coastal waters are exposed and remote in nature, with a character that is strongly influenced by the presence of the existing Dudgeon and Sheringham Shoal offshore wind farms, a dense concentration of shipping activity, and extensive offshore commercial activities, such as fishing and dredging.

806. A number of landscape designations are present along the coast and inland and include the nationally important Norfolk Coast Area of Outstanding Natural Beauty (AONB), which is present along the majority of the north Norfolk coast between Hunstanton and Mundesley and approximately 15.9km from the SEP and 26.7km from the SEP. Both landfall options overlap with the AONB to some extent – refer to **Figure 4.1.1** in **Appendix 2**. The north Norfolk coast between Hunstanton and Weybourne is also designated as heritage coast (North Norfolk Heritage Coast) as well as being a Ramsar site, SAC and SSSI.

807. Landscape character principally applies to areas lying to the landward side of the high-water mark. The English Landscape is classified at the national level by National Character Areas (NCAs). This mapping and the associated descriptions have been revised and developed by Natural England into NCA profiles, which provide a recognised national spatial framework. The onshore scoping area covers a coastal and rural landscape in which agriculture is the predominant land use. Settlements are typically small, occurring as villages and towns along the Norfolk coast, and then more intermittently inland, with a finer network of small clusters of properties and isolated farmsteads characterising the rural area.

808. The onshore areas are characterised by the following NCAs:

- North West Norfolk (NCA 76);
- North Norfolk Coast (NCA 77);
- Central North Norfolk (NCA 78);

- North East Norfolk and Flegg (NCA 79);
- The Broads (NCA 80);
- South Norfolk and High Suffolk Claylands (NCA 83); and
- Mid-Norfolk (NCA 84).

809. The Norfolk and Suffolk Broads National Park (the Broads) is Britain's largest protected wetland and third largest inland waterway, and is located approximately 34km from the SEP turbine array and 37km from the DEP turbine at its closest point. Significant impacts on the landscape character of the Broads from the wind turbines are unlikely due to the long distance of the turbine arrays from the Broads. In addition, there is limited visibility to the sea afforded from the landscapes of the Broads, which are located further inland, are very low-lying and are partially screened by surrounding landforms and intervening vegetation (woodland and hedgerows). On this basis, it is proposed that potential operational landscape impacts associated with the offshore presence of the proposed wind farm extensions on the Broads be scoped out of the assessment.

810. The Option 2 onshore cable route scoping area is, however, located within approximately 1.2km of the Broads, near East Ruston. There are also several Registered Parks and Gardens in the onshore study area (see **Figure 4.1.1** in **Appendix 2**).

811. Historic landscape/seascape character will be addressed as part of the historic environment assessments (see **Sections 2.9** and **3.5**).

#### 4.1.1.2 Visual Receptors

812. The principal seascape visual receptors in the study area are likely to be focused along the closest sections of the Norfolk coastline. A detailed assessment will be undertaken in the SLVIA for those visual receptors that are most susceptible to changes along the Norfolk coastline and immediate hinterland, including:

- Coastal settlements – including Wells-next-the-Sea; Sheringham; Cromer; Trimingham; Mundesley; Bacton; Happisburgh; and Eccles on Sea;
- Recreational routes – including Norfolk Coast Path; Regional Cycle Routes 30 and 31; National Cycle Route 1;
- Main road routes – various roads that lead to the coast such as the A140, A148, A149, A1082, B1159, and B1145; and
- Visitors to tourist facilities – such as the sea fronts / beaches of the main coastal towns and resorts, holiday villages and nature reserves and visitors centres (**Figure 4.1.2** in **Appendix 2**).

813. With respect to the onshore works the principal visual receptors are likely to be people walking on the Norfolk Coast Path and other public rights of way in proximity to the onshore infrastructure. Views of the onshore infrastructure may also be experienced by residents of settlements such as Swardeston, Swainsthorpe and Stoke Holy Cross as well as residents of scattered individual farm houses and estates and by motorists travelling within the study area.



## 4.1.2 Potential Impacts

814. The Seascape, Landscape and Visual assessment is likely to have key inter-relationships with Shipping and Navigation, Traffic and Transport, Tourism and Recreation, and Archaeology and Cultural Heritage. These will be considered where relevant.

### 4.1.2.1 Potential Impacts During Construction

#### *Offshore*

815. Potential visual impacts related to the offshore construction would be seen in the context of the existing shipping and other offshore commercial activities, including the presence of the existing wind farms. The seascape, landscape and visual impacts that could arise during construction include:

- Temporary impacts on coastal/seascape character;
- Temporary impacts on landscape character; and
- Temporary visual impacts on views.

#### *Onshore*

816. Potential impacts during construction would occur in relation to the construction of the landfall, onshore cable corridor, onshore substation and National Grid infrastructure. These would include potential impacts on the landscape character and visual amenity of the site and surrounding area. The impacts would relate principally to the construction process, and presence of associated plant, materials, infrastructure and temporary structures, as well as the presence of emerging structures, where they would be visible above ground.

### 4.1.2.2 Potential Impacts During Operation

#### *Offshore*

817. The potential for significant visual impacts to arise in respect of the offshore components during operation would be in the context of the existing Sheringham Shoal and Dudgeon offshore wind farm turbines. The extension areas are typically located seaward of the existing turbine arrays – Equinor deliberately selected the boundaries of the SEP array to be no closer to the coastline than the existing wind farm. However, the extensions would introduce taller turbines and effectively widen the footprint of the existing wind farms on the horizon. The following impacts will be assessed:

- Impacts on coastal / seascape character – either affecting the pattern of elements that define the character or affecting the visual/perceptual seascape characteristics;
- Impacts on landscape character – within onshore landscape types and landscape designations, primarily as a result of visibility of the offshore wind turbines during operation; and
- Impacts upon visual receptors (groups of people) associated with the visibility of the proposed offshore extension sites; including specific viewpoints and on the visual amenity/experience of the landscape.

*Onshore*

818. Potential impacts during operation relate principally to the presence of the onshore substation (since the onshore cables will be buried). Potential impacts on landscape character and visual amenity will be assessed, with particular consideration of sensitive receptors such as valued landscapes, residents, recreational users of the countryside and road-users. Potential impacts during operation would be considered in the context of the proximity of this infrastructure to the existing electrical infrastructure at Norwich Main.

**4.1.2.3 Potential Impacts During Decommissioning**

819. It is anticipated that the decommissioning impacts would be similar in nature to those of construction, but would be more limited in geographical extent and timescale.

820. Decommissioning will include potential impacts on the landscape character and visual amenity of the sites and surrounding area. The impacts would relate principally to the decommissioning process, associated plant, materials, infrastructure and temporary structures, as well as the presence of dismantled structures, where they would be visible above ground.

**4.1.2.4 Potential Cumulative Impacts**

821. Potential cumulative impacts would relate to the association with other large scale developments (existing and proposed), located either in, or close to the study area. Further consideration will be given to these potential cumulative scenarios as part of the EIA in-combination with other projects.

**4.1.2.5 Summary of Potential Impacts**

*Table 4-1 Summary of impacts relating to seascape, landscape and visual*

Potential Impacts	Construction	Operation	Decommissioning
Impacts of the offshore works on seascape / landscape character and visual amenity	✓	✓	✓
Impacts of the offshore works on seascape, landscape and visual receptors	✓	✓	✓
Impacts of the offshore works on the landscape character of the Norfolk and Suffolk Broads National Park	x	x	x
Impacts of the onshore works on landscape character and visual amenity	✓	✓	✓
Impacts of the onshore works on landscape and visual receptors	✓	✓	✓
Cumulative impacts with other offshore projects	✓	✓	✓
Cumulative impacts with other onshore projects	✓	✓	✓

### 4.1.3 Approach to Assessment and Data Gathering

822. The assessment will be undertaken in accordance with the methods outlined in the following best practice guidance documents:
- The Landscape Institute with the Institute of Environmental Management and Assessment (2013). Guidelines for the Assessment of Landscape and Visual Impacts, Third Edition;
  - Landscape and Seascape Character Assessments published by Natural England and the Department for Environment, Food and Rural Affairs (2014);
  - An Approach to Landscape Character Assessment (2014). Natural England;
  - Scottish Natural Heritage (2012). Assessing the Cumulative Impact of Onshore Wind Energy Developments;
  - Scottish Natural Heritage (February 2017). Visual Representation of Wind Farms: Version 2.2; and
  - The Landscape Institute (2011). Landscape Institute Advice Note 01/11, Photography and photomontage in landscape and visual impact assessment.
823. Data will be gathered from official, reliable and the most up-to-date sources. This will include Ordnance Survey map based data as well as data on landscape characterisation, landscape designations and other Governmental and local authority data of relevance.
824. The methodology to undertake the SLVIA will reflect 'Guidelines for Landscape and Visual Impact Assessment: Third Edition' (GLVIA3) (Landscape Institute, 2013). The significance of effects will take into account the sensitivity of the landscape or visual receptor / view and the magnitude of change that will result from DEP and SEP. In accordance with GLVIA3, the approach will require the application of professional judgment, but generally, the higher the sensitivity and the higher the magnitude of change, the increased likelihood there is for a significant effect.
825. The SLVIA will determine whether the impacts are beneficial, neutral or adverse in accordance with defined criteria; and will be assessed as short-term or long-term, and permanent or temporary/reversible.

*Table 4-2 Data sources that will be used to inform the assessments*

Data source	Data
Ordnance Survey	Mapping information
North Norfolk District Council	North Norfolk Landscape Character Assessment
Broadland District Council	Broadland Landscape Character Assessment
Norfolk Coast Partnership	Norfolk Coast AONB Management Plan
The Broads Authority	Identification of a landscape of national importance
MAGIC website	AONBs, Historic Parks and Gardens, National Character Areas, National Trails.
Norfolk County Council	PRoW definitive map

## 4.2 Socio-Economics

826. The specific assessment requirements for socio-economics are set out within National Policy Statement EN-1 and are summarised in **Table A1-23** in **Appendix 1**.

827. Tourism aspects of socio-economics are considered in **Section 4.4**.

### 4.2.1 Existing Environment

828. The existing environment relevant to the EIA would consider two receptor groups:

- Economic receptors, essentially people or businesses that would benefit from or be adversely affected by DEP and SEP and associated development; and
- Social receptors, which are the social infrastructure relevant to a community, that would benefit from or be adversely affected by DEP and SEP and associated development. Impacts on social receptors subsequently impact on the population often in ways that influence their health and wellbeing.

829. Norfolk is one of three counties in the East Anglia region of Eastern England. It has a population of just over 900,000 people and is administered by Norfolk County Council. Forty percent of the county's population live in the built-up areas of Norwich (213,000), Great Yarmouth (63,000), King's Lynn (46,000) and Thetford (25,000). Norwich also has a population of roughly 20,000 students attending its two universities (University of East Anglia (UEA) and Norwich University of the Arts).

830. Of the population in Norfolk, 58.8% is aged between 16 and 64 and of those 74.4% are employed and 3.9% are unemployed (ONS, 2018). Skilled trades, technical and professionals comprise 52.7% of employment, the remainder being retail, leisure, caring, plant and process, and elementary and unskilled occupations (ONS, 2018) of which construction (14.3%), professional, scientific and technical (13.4%), and agriculture (10.2%) are the largest employers by number followed by the retail (7.8%) and accommodation/food services (7.1%) (ONS, 2018).

831. The scoping area includes areas managed by Norfolk County Council and the local district councils of North Norfolk, Broadland and South Norfolk. The substation search area slightly encroaches on land managed by Norwich City Council.

832. The scoping area passes through the jurisdiction of North Norfolk, Broadland and South Norfolk District Councils, and is predominantly located on agricultural land.
833. Businesses within the immediate vicinity of the cable corridor include pubs, tourist attractions such as a dinosaur park and heritage railway (see [Section 4.4](#)), hotels, restaurants, farms, garages, a motorcycle training centre, various types of shop, garden centre, shooting ground, paintball centre, swimming pool, and a country park.
834. Areas within the landfall search area have suffered from coastal erosion and flooding. A coastal 'sand scaping' protection scheme has recently been approved for the coastline adjacent to Bacton Gas Terminal.
835. The main economic activities within the landfall search areas are associated with arable farming and tourism, as well as employment associated with the Bacton Gas Terminal. Mundesley Holiday Village and Castaways Holiday Park are located within 50m of the Bacton landfall search area.
836. Settlements within/near to the landfall search area include Weybourne, Sheringham, Bacton and Mundesley. All of these settlements have B&Bs, hotels, cafes and restaurants, and public houses.
837. The substation search area is in the district of South Norfolk. The area contains some notable tourist attractions (see [Section 4.4](#)) as well as the settlements of Keswick, Intwood, Caistor St Edmund, Dunston, Stoke Holy Cross, Swainsthorpe, and Mulbarton.
838. The offshore project area is primarily used by commercial fisheries (see [Section 2.7](#)) and shipping (see [Section 2.8](#)). Significant natural gas infrastructure exists to the north of the site and much of it feeds into the Bacton Gas Terminal at the north end of the landfall search area.

#### 4.2.2 Potential Impacts

839. Offshore wind farm projects, particularly at the scale planned for DEP and SEP, can have positive socio-economic effects in terms of providing local and national employment, and continuing to develop the wind energy market at a national level, i.e. encouraging wind energy manufacturers to be based in the UK. It is anticipated that the economic impact, both direct and indirect will be most significant during the construction phase, with a lesser direct impact on the local economy during the operational phase. However, there are potential negative impacts on social infrastructure where the project components and activities to construct them impact on specific receptors, unless they are identified and avoided through micro-siting and mitigation measures. The impacts described below exclude tourism and recreation, which are considered in [Section 4.4](#).
840. Economic impacts will vary considerably at each stage, dependent on a range of factors, such as:
- The technologies and infrastructure to be deployed onshore and offshore;
  - Construction, O&M and decommissioning methodologies;
  - Procurement/contracting strategy;
  - Availability and capacity of the supply chain;
  - Number of workers;
  - Where the workers come from; and

- The duration of employment.

841. The Socio-economics assessment is likely to have key inter-relationships with Commercial Fisheries, Tourism and Recreation, and Land Use and Agriculture. These will be considered where relevant.

#### 4.2.2.1 Potential Impacts During Construction

- Supply chain: The proposed wind farms will require local goods and services, which will be supplied by local businesses such as security, catering, hotel facilities or maintenance;
- Infrastructure: Potential for upgrade of existing or new ports and improved infrastructure;
- Employment: Whilst some of the offshore work contractors are likely to be non-UK residents, the onshore and landfall works have the potential to use local contractors certainly for some elements of the work and may also require local recruitment. Though it is likely that contractors could come from anywhere within the UK. Overall, there is likely to be some local recruitment / employment but linked to relevant contractor location.
- Local expenditure: There will be a social and economic impact that relates to the new spending power generated from employees directly and indirectly attached to the wind farms. A significant amount of the earning capacity of these individuals is expected to be spent locally, boosting the local economy.
- Loss of or disruption to social infrastructure: The working areas and exclusion areas during construction could result in the obstruction to or disruption of key social infrastructure elements. This could be loss of area or complete cessation of the activities present at such receptors for the duration of construction.
- Disturbance (noise, air, visual, and traffic) to social infrastructure: During the installation of the onshore infrastructure, noise, dust and visual disturbance could all cause potential impacts on social infrastructure receptors or the users thereof. However, these will be temporary in nature. Impacts from dust and noise are considered in **Section 3.6** and **Section 3.7**, and visual impacts are considered in **Section 4.1**.

#### 4.2.2.2 Potential Impacts During Operation

- Employment: The design life of the offshore wind farm is 25 years, rising to potentially 60 years following any future re-powering, and will require the employment of staff for operations, maintenance, potentially re-powering after 25 years, and ultimately decommissioning.
- Wider impacts: The potential wider social economic impacts over an operational life of up to 50 years are wide ranging but relate to aspects such as indirect economic expenditure and in-migration and the associated demographic change that could arise, and these will be identified and assessed as part of the EIA.



- Loss of or disruption to social infrastructure: The permanent footprint of the project infrastructure could result in the obstruction to or disruption of key social infrastructure elements. This could result in the permanent loss of area or complete cessation of the activities present at such receptors.
- Disturbance (noise, air, visual, and traffic) to social infrastructure: There would be no ongoing activities during the operation phase that would result in disturbance to social infrastructure receptors with the exception of maintenance activities, which could result in increased noise, dust, traffic, or visual disturbance. However, these will be temporary in nature albeit intermittent throughout the operational phase. Impacts from dust and noise are considered in **Section 3.6** and **Section 3.7**, and visual impacts are considered in **Section 4.1**.

#### 4.2.2.3 Potential Impacts During Decommissioning

842. Impacts from decommissioning are anticipated to be similar to those from construction activities.

#### 4.2.2.4 Potential Cumulative Impacts

843. There is potential for Dudgeon and Sheringham Shoal to bring socio-economic benefits, for example by providing opportunities for business, jobs and training. The clustering of offshore wind farm development in the southern North Sea will, over time, provide longer term opportunities for the supply chain and skills sectors than a single development.

844. Conversely, there is also potential to cumulatively impact upon other industries negatively as a result of displacement of workers currently employed in other industries. This will be considered further in the EIA.

#### 4.2.2.5 Summary of Potential Impacts

*Table 4-3 Summary of socioeconomic impacts to be considered Transport (scoped in (✓) and scoped out (x))*

Potential impacts	Construction	Operation	Decommissioning
Direct economic benefit	✓	✓	✓
Increased employment	✓	✓	✓
Change in demographics due to in-migration	x	✓	x
Loss of or disruption to local infrastructure	✓	✓	✓
Disturbance (noise, air, visual, and traffic) to social infrastructure	✓	✓	✓
Pressure on local health infrastructure (doctors' surgeries / hospitals / dentists)	✓	✓	✓

Potential impacts	Construction	Operation	Decommissioning
Cumulative socio-economic impacts	✓	✓	✓

### 4.2.3 Approach to Assessment and Data Gathering

845. A review of the socio-economic baseline features will be undertaken and presented in the ES, including:
- Regional and local labour market and trends;
  - High level indication of temporary and rented accommodation supply and trends;
  - Current workforce;
  - Local and regional population and trends;
  - Local and regional employment and trends; and
  - Education (including special educational needs and school standards).
846. Social data relating to crime, health and leisure will also be considered where this is available, along with the identification of social infrastructure such as schools, nurseries, libraries, doctors, dentists, pharmacies, social care homes, post offices, public houses, community halls, churches and other places of worship. Data on health is presented in **Section 4.3**.
847. Data sources for this baseline review would include:
- ONS (Office for National Statistics);
  - norfolkinsight.co.uk; and
  - NOMIS.
848. All data will be linked to the Lower Layer Super Output Areas (LLSOAs) for the areas within the relevant disturbance zone of the likely impacts, whether they are direct (physical) or indirect (transport and access, noise, air / dust) impacts. All LLSOAs for Norfolk will be linked to the tabulated data on social and economic data listed above.
849. The Overarching NPS for Energy (EN-1) states that where a project is likely to have an impact on socio-economics at a local or national scale the assessment should consider all relevant impacts, including those listed at the start of this section.
850. There is no set of recognised standards for the assessment of socio-economic impacts. In light of this, the socio-economic assessment will present a qualitative assessment of the anticipated impacts and benefits, their extent and when they are expected to occur.
851. The absolute scale of economic impacts (i.e. the number of jobs which construction, operation and maintenance, and decommissioning activity is expected to support) would be calculated using an approach consistent with methods for economic impact assessment set out in HM Treasury Green Book (2003). The socio-economic impact magnitude will be determined by consideration of the predicted deviation from baseline conditions.

## 4.3 Health

852. The specific assessment requirements for human health are set out within National Policy Statement EN-1 and are summarised in **Table A1-24** in **Appendix 1**. Information on assessment requirements for specific impacts on health can be found in the relevant chapters.

### 4.3.1 Existing Environment

853. Human health will be considered within the relevant onshore technical topics during the EIA, including noise and vibration, flood risk, traffic and transport, air quality, and ground contamination.

854. Receptors that are sensitive to potential impacts on health will be identified within the topic specific ES chapters, and a review of these will be presented within the health assessment. A review of the health interactions of the project and those in the receiving environment will be drawn from those other assessments.

#### 4.3.1.1 Overview

855. Life expectancy in Norfolk is 80 years for males and 83.7 years for females.

856. Ninety four percent of the population of Norfolk considered themselves to be in very good to fair health, and only 5.6% of the population considered themselves to be in bad or very bad health (ONS, 2011). However, 27% of households had a person with a long-term health issue or disability (ONS, 2011).

857. Of the adult population, smokers comprised 11.6% and 16.2% of females and males respectively, whilst 7.9% of 15-year olds considered themselves to be regular smokers (ONS, 2011).

858. Nearly 3,000 people died as a result of preventable (lifestyle) cardiovascular disease or cancer. Over 60% of adults are classified as overweight or obese, with 22.7% of 4-5 year olds overweight and 32.1% of 10-11 year olds overweight. Though over 65% of adults considered themselves to be active.

859. There were 6,150 hospital admissions for alcohol related conditions and 1,498 emergency admissions for self-harm in one year. There were 39.07 people per 100,000 killed or severely injured on roads in Norfolk in 2011 (The Guardian, 2012).

860. Thirty seven percent of households had an adult residing in them who was unemployed, and 3.8% of the working age population was long-term unemployed. Twenty five percent of households had dependent children, and 14.8% of children lived in low-income families.

861. Additional data on health-related statistics will be sought to highlight key sensitivities within the County and the various districts and parishes of Norfolk. In terms of deprivation Norfolk is around the average for the UK (ranked 85 out of 152), though there are pockets of high deprivation in urban locations such as Norwich, Dereham, Swaffham, Great Yarmouth, but also coastal areas including Hemsby, and Cromer.

### 4.3.2 Potential Impacts

862. The Health assessment is likely to have key inter-relationships with Noise and Vibration, Air Quality and Tourism and Recreation. These will be considered where relevant.

#### 4.3.2.1 Potential Impacts During Construction

863. Potential health related effects experienced during construction would be determined through the topic specific assessments, but are expected to include:

- Noise disturbance;
- Dust and other air emissions;
- Exposure to contaminated soils;
- Hazardous waste and substances;
- Increased flood risk;
- Navigation risk;
- Obstruction to or loss of green space;
- Disruption to local road network (reduced access to services and amenities);
- Transport related accidents;
- Community anxiety and stress; and
- Loss of or increased pressure on existing healthcare services.

#### 4.3.2.2 Potential Impacts During Operation

864. Potential health related impacts during operation would be determined through the topic specific assessments, but are expected to include:

- Noise disturbance associated with the operational substation and National Grid Infrastructure;
- Obstruction to or loss of green space;
- Generation of electromagnetic fields (EMFs);
- Increased flood risk;
- Navigation risk; and
- Community anxiety and stress.

#### 4.3.2.3 Potential Impacts During Decommissioning

865. It is anticipated that the decommissioning impacts would be similar in nature and extent to those of construction.

#### 4.3.2.4 Potential Cumulative Impacts

866. Cumulative impacts will be considered as part of the EIA process. Any other projects with the potential to result in impacts that may act cumulatively with DEP and SEP will be identified during consultation. These projects will then be included in the CIA and therefore are scoped into the assessment.

867. The assessment would consider the potential for significant cumulative impacts to arise as a result of the construction, operation, and decommissioning of DEP and SEP in the context of other developments that are existing, consented or at application stage.

#### 4.3.2.5 Summary of Potential Impacts

*Table 4-4 Summary of impacts relating to human health Transport (scoped in (✓) and scoped out (x))*

Potential Impacts	Construction	Operation	Decommissioning
Noise disturbance	✓	✓	✓
Emissions to air (including dust)	✓	X	✓
Exposure to contaminated soils	✓	X	✓
Accidental / incidental chemical spills / leaks to surface / ground / coastal waters or soils	✓	X	✓
Increased Flood Risk	✓	✓	✓
Navigation Risk	✓	✓	✓
Obstruction to or loss of open space and associated health benefits	✓	✓	✓
Disruption to local road network (reduced access to services and amenities)	✓	✓	✓
Transport related accidents	✓	✓	✓
Community stress and anxiety as a result of increased pollution (water) risk, flood risk, noise, visual, heavy traffic, or crime due to in-migrant workers	✓	✓	✓
Loss of or pressure on existing healthcare services	✓	✓	✓
Cumulative impacts	✓	✓	✓
Transboundary impacts	X	X	X

### 4.3.3 Approach to Assessment and Data Gathering

868. There are no specific guidelines which inform the management or assessment of health impacts. The Overarching National Policy Statement for Energy (EN-1) (DECC, 2011a) states that where the proposed project has an effect on human beings, the ES should assess these effects for each element of the project, identifying any adverse health impacts, and identifying measures to avoid, reduce or compensate for these impacts as appropriate.

869. In line with good practice, the assessment process will include the identification and review of the potential public health impacts of the full life-cycle (i.e. construction, operation and decommissioning) of the project’s features, including their emissions. The findings will be taken from individual chapters from the ES and collated in the health assessment. In addition, feedback will be sought from consultees on potential health impacts, with particular reference to the Health and Safety Executive (HSE) and Public Health England (PHE).

870. Data sources relating to human receptors are discussed in the following sections:

- 2.2 Marine Water and Sediment Quality
- 3.1 Onshore Ground Conditions and Contamination
- 3.6 Air Quality
- 3.7 Noise and Vibration
- 4.1 Seascape, Landscape and Visual
- 4.2 Socio-Economics; and
- 4.4 Tourism and Recreation.

871. **Table 4-5** summarises the data sources used to obtain the baseline scoping data.

*Table 4-5 Baseline data sources*

Data source	Date	Data contents
ONS	29/07/2019	Health statistics at local, county, and regional levels.
OS Maps	29/07/2019	OS maps combined with ONS data for lower level super output areas to identify detailed community and population data at relevant spatial locations.
Public Health England	29/07/2019	Health statistics for various regions and demographics.

#### 4.4 Tourism and Recreation

872. The specific assessment requirements for tourism and recreation are set out within National Policy Statement EN-1 (under socio-economics), and are summarised in **Table A1-25** in **Appendix 1**.

873. Socio-economic aspects of tourism and recreation are considered in **Section 4.2**.

##### 4.4.1 Existing Environment

874. Tourism is very important to the economy of Norfolk, providing over 65,000 jobs and contributing more than £3.25 billion to the local economy (Visit Norfolk, 2017). Norfolk’s attractions include its un-spoilt coastline, beautiful countryside, internationally important nature reserves, picturesque market towns and traditional seaside resorts. **Figure 4.4.1** in **Appendix 2** shows the most notable features in the immediate vicinity of the landfall search areas.



#### 4.4.1.1 Coastal Tourism and Recreation

875. The Weybourne landfall search area is within the Norfolk Coast Area of Outstanding Natural Beauty (AONB). North Norfolk is described as ‘an extremely diverse tourism offer, primarily due to its varying landscape comprising an attractive coastline, much of which is AONB, extensive countryside, coastal birdlife, seaside resorts, historic towns and villages and the Norfolk Broads’. Coastal recreational activities include coastal walks, cycling and sight-seeing amongst many others. Both landfall search areas are within Norfolk’s Deep History Coast, known for its archaeological finds.
876. The main coastal resort in proximity to the Weybourne landfall search area is the village of Weybourne and its associated beach. The larger coastal settlement of Sheringham is approximately 2km east of the landfall site and is itself a popular tourist resort. Weybourne is known for its beach-angling (due to deep water), the Muckleburgh Tank Collection, and as a stop on the North Norfolk steam railway, as well as various other recreational activities.
877. Bacton and Mundesley are the two resorts in proximity to Bacton landfall search area, both known for their wide, sandy beaches. Mundesley is the larger of the two resorts and has a Blue Flag beach as well as various recreation amenities (see [Table 4-6](#)).
878. Marine recreational activities include sailing and motor craft activities, and include fishing, SCUBA diving and other water sports. Offshore, in the vicinity of the proposed wind farm extensions, any sailing would likely consist of offshore cruising and racing. A number of offshore routes fan out from the coastal area, which are likely to intersect the proposed developments. These routes will be identified in the NRA, included in [Section 2.8](#).
879. Within the inshore area, which is traversed by the proposed export cable route options and encompasses a RYA general boating area, inshore sailing is typically undertaken by smaller vessels including dinghies and recreational craft. Inshore racing takes place around racing marks and navigational buoyage. Recreational SCUBA diving is known to take place at locations within the Cromer Shoal Chalk Beds MCZ as well as on local wrecks. There are no boat trips or water sports facilities within the coastal and near-shore scoping area, although there are some operating out of/in Sheringham, close to Weybourne landfall search area. Recreational sailing and vessels are covered separately in [Section 2.8](#). Other water sport activities including surfing, wind and kite surfing, kayaking, canoeing and recreational fishing are pursued close to shore, and potentially in proximity to the proposed export cable routes.
880. The Blue Flag beach at Mundesley (Bacton landfall search area) provides good swimming opportunities.
881. Various Public Right of Ways (PRoWs) and cycle routes are located within the study area of both landfall options, including national cycle routes 30 and 33 (see [Figure 4.4.1](#) in [Appendix 2](#)). The Weybourne landfall search area crosses the Peddars Way and Norfolk Coastal Path (see [Figure 4.4.1](#) in [Appendix 2](#)). The specific amenities offered by each resort are detailed in [Table 4-6](#).

*Table 4-6 Coastal resort amenities*

Resort	Landfall search area	Assets
Sheringham	Weybourne	Blue Fag beach, clifftop walking, public houses, restaurants, theatre, heritage steam railway, Norfolk Coast AONB, Heritage Coast.
Weybourne	Weybourne	Military museum, park, steam railway, pebbled beach, public house, windmill, deep nearshore waters for beach angling, Norfolk Coast AONB, Heritage Coast.
Mundesley	Bacton	Victorian seaside village with Blue Flag beach, clifftop walking, cinema, public houses, golf course, museum, WWII memorial, windmill, restaurants, Norfolk Coast AONB.
Bacton	Bacton	Beaches, clifftop walking, 15 <sup>th</sup> century church, public houses.

#### 4.4.1.2 Inland Tourism and Recreation

882. The onshore scoping area runs through the North Norfolk, Broadland and South Norfolk Districts. The majority of North Norfolk’s tourism is at its coasts and within the main towns, although the North Norfolk AONB is approximately 3.5km wide as it follows the coast, which offers an inland attraction to tourists.
883. The Broadland, Norwich and South Norfolk Joint Core Strategy describe a ‘rich concentration of historic assets, dominated by the medieval city of Norwich and its surrounding market towns, and also includes historic buildings, halls and parklands in the surrounding countryside’.
884. Amenities in proximity to the onshore scoping area include campsites, caravan parks, some B&Bs/guesthouses, fishing lakes, Sheringham Park, PRowWs, national cycle routes 1, 30 and 33, commons/public open spaces, archery and paintball parks, Baconsthorpe Castle, and the North Norfolk and Bure Valley steam railways. The award-winning ‘Roarr!’ Dinosaur adventure centre is also located within the onshore scoping area.
885. Ventura Icenorum Roman town, Dunston Common, and Dunston Hall hotel and golf course are located within the substation search area.

#### 4.4.2 Potential Impacts

886. The Tourism and Recreation assessment is likely to have key inter-relationships with Socio-economics, Seascape, Landscape and Visual, and Traffic and Transport (in particular with regard to labour resources). These will be considered where relevant.

##### 4.4.2.1 Potential Impacts During Construction

###### *Coastal*

- Visual impacts: Associated with cable laying vessels and vessels moving to and from the offshore construction zone, as well as plant, machinery, personnel at the coastal landfall (see **Section 4.1**).

- Disruption to marine and coastal recreational activities: Offshore and landfall construction activities and associated Safety Zones may disrupt marine and coastal recreational activities, and these will need to be identified and assessed. This obstruction or disruption will be temporary in nature. Marine users will be informed of Safety Zones, and these will be removed or reduced following completion of construction. The risk of collision with structures and reduced navigable area as a result of the construction activity will be assessed and is discussed in [Section 2.8](#).
- Restricted beach access: There is the potential for beach access to be obstructed during works at the landfall, for health and safety purposes. However, this will be temporary in nature, with access restored upon completion of construction.
- Deterioration of Bathing water / Blue flag beaches and resulting effect on tourism and recreation: The landfall and associated nearshore cable construction works could result in deterioration to the Bathing Water / Blue Flag beach status of nearby beaches. Such deterioration could discourage visits by both residents and non-residents and result in local economic decline. Impacts to water quality are discussed in [Section 2.2](#).

#### *Onshore (inland)*

- Loss of or disruption to recreation / tourism assets: The working areas and exclusion areas during construction could result in the obstruction to or disruption of key recreational assets or activities.
- Obstruction to local recreation and tourism provisions and businesses: Local businesses and tourism facilities may be temporarily disrupted through access route diversions as a result of construction work (see [Section 3.7.3](#)).
- Alternate routes/closure of PRowS and cycle paths: Temporary closures or alternative routes for PRowS (including National Trails), cycle routes and other long-distance paths could discourage visitors.
- Disturbance to recreation / tourism assets from noise, dust and visual impact: During the installation of the onshore infrastructure, noise, dust and visual disturbance could all cause potential impacts to tourism or recreational receptors. However, these will be temporary in nature. Impacts from dust and noise are considered in [Section 3.6](#) and [Section 3.7](#), and visual impacts are considered in [Section 4.1](#).
- Reduction in available accommodation due to construction personnel: Where there is a non-resident construction workforce there will need to be temporary / short-term accommodation during the construction phase. Whilst this will be a positive economic impact for accommodation providers, the reduction in available accommodation could reduce the availability of accommodation for tourists and could be considered a potential negative impact. This could have both temporary, short- and longer-term impacts.

#### 4.4.2.2 Potential Impacts During Operation

- Disruption to coastal and marine recreational activities: The main source of impact is associated with Safety Zones during maintenance activities in the coastal and marine environment. Impacts on recreational vessels from a navigational perspective will be considered in **Section 2.8**.
- Permanent closure of PRoWs: If any PRoWs require permanent closure as a result of the proposed infrastructure, this would reduce availability of access as well as attractiveness the area for informal recreational activities such as walking. However, the project will seek to avoid placing permanent operational above ground infrastructure on a PRoW.
- Disturbance to recreation / tourism assets from onshore noise, dust and visual impact: There would be no ongoing activities during the operational phase that would result in disturbance to tourism or recreation receptors with the exception of maintenance activities, which could result in increased noise, dust, traffic, or visual disturbance. However, these will be temporary in nature albeit intermittent throughout the operational phase. Impacts from dust and noise are considered in **Section 3.6** and **Section 3.7**, and visual impacts are considered in **Section 4.1**.
- Disturbance to recreation / tourism assets from offshore visual impact: The operational offshore wind farms may be located as close as 15.9km to the North Norfolk coast (SEP). The largest turbines under consideration would have a tip height of 276m, which would have visibility along a large stretch of the North Norfolk coast and inland. Whilst the existing Sheringham Shoal and Dudgeon Offshore Wind Farm turbines are visible from the coast the larger turbines proposed have the potential to increase the zone of theoretical visibility of the wind farms, which may result in an effect on tourism and recreation receptors. Visual impacts are considered in more detail in **Section 4.1**.
- Reduction in available accommodation due to maintenance personnel: The attendance of non-resident maintenance personnel during the annual maintenance season represents a need for temporary / short-term accommodation throughout the operational lifetime. Accommodation providers may prioritise workers' accommodation over tourist visitors, thus reducing the available provision (albeit intermittently) and resulting in a potential long-term impact.

#### 4.4.2.3 Potential Impacts During Decommissioning

887. No decision has been made regarding the final decommissioning policy for the substation as it is recognised that industry best practice, rules and legislation change over time. However, the substation and cable relay station equipment will likely be removed and reused or recycled. It is expected the onshore cables will be removed from ducts and recycled, with the transition pits and ducts left in situ.

888. The detail and scope of the decommissioning works will be determined by the relevant legislation and guidance at the time of decommissioning and agreed with the regulator. A decommissioning plan would be provided.

889. It is anticipated that the decommissioning impacts will be similar in nature to those of construction. There is the potential for a positive impact as a result of reverting land to previous or improved condition, making the area more attractive to visitors.

#### 4.4.2.4 Potential Cumulative Impacts

890. Onshore cumulative impacts will be considered as part of the EIA process. Any other project with the potential to result in impacts that may act cumulatively with DEP and SEP will be identified during consultation and following a review of available information.

891. The assessment would consider the potential for significant cumulative impacts to arise as a result of the construction, operation and decommissioning of DEP and SEP in the context of other developments that are existing, consented or at application stage.

892. For a cumulative impact to arise during construction, for example, on beach users, recreational sea users and on tourism and recreational facilities, a development would have to happen at the same time and be within a similar area.

#### 4.4.2.5 Summary of Potential Impacts

*Table 4-7 Summary of potential impacts on Tourism and Recreation Transport (scoped in (✓) and scoped out (x))*

Potential impacts	Construction	Operation	Decommissioning
<b>Coastal and marine</b>			
Visual impacts	✓	✓	✓
Disruption to marine and coastal recreational activities	✓	✓	✓
Restricted beach access	✓	x	✓
Deterioration to Bathing water / Blue flag beaches and resulting effect on tourism and recreation	✓	x	✓
<b>Onshore (inland)</b>			
Visual impacts	✓	✓	✓
Loss of and disturbance to local tourism and recreation assets	✓	x	✓
Alternate routes / temporary/permanent closure of PRoWs	✓	✓	✓

Potential impacts	Construction	Operation	Decommissioning
Disturbance to recreation / tourism assets from noise, dust and visual impact	✓	x	✓
Reduction in available accommodation due to construction personnel	✓	✓	✓
Cumulative impacts	✓	✓	✓

#### 4.4.3 Approach to Assessment and Data Gathering

893. There are no specific statutory guidelines which inform the assessment of impacts upon tourism and recreation receptors. The assessment will focus on the factors that have the potential to reduce the number of tourists visiting or returning to an area. The tourism baseline will be described on the basis of trends for visitor numbers, visitor origin, expenditure, secondary benefits from tourism, and the timing of visitor periods.

894. A desk-based study will be undertaken to identify tourism and recreation features which may be affected by the proposed DEP and SEP, using sources of information online (see **Table 4-8**) and through continued consultation with statutory stakeholders, as well as feedback and information from survey teams carrying out other surveys in the cable corridor and landfall areas (such as terrestrial ecology).



*Table 4-8 Tourism and Recreation data sources*

Data source	Data contents
visitnorfolk.co.uk	General information on tourism in Norfolk and location/details of specific attractions.
Google Maps	Locating/searching for attractions within the development area.
Bing OS Maps	Searching for tourism assets within the development area including PRowS and cycle paths.
North Norfolk District Council	Information on local plans and designations.
Broadland District Council	Information on local plans and designations.
RYA	UK Coastal Atlas of Recreational Boating (September 2019). GIS dataset of recreational boating activity around the UK, comprising spatial data including indicators of intensity of use, general boating areas, offshore routes, as well as the locations of clubs, training centers and marinas.
Defra Sea Angling Survey (2012)	A survey of shore-based and private boat recreational sea angling activity and economic value of sea angling in England.
SeaSearch	A project for volunteer scuba divers and snorkelers who survey and map types of near-shore sea bed around Britain.
Finstrokes dive sites	Source of dive site information for SCUBA divers.

895. The assessment will be undertaken in accordance with following relevant guidance:

- The RYA's Position on Offshore Renewable Energy Developments: Paper 1 (of 4) – Wind Energy, June 2019 (RYA, 2019); and
- Guidance on Environmental Impact Assessment of Offshore Renewable Energy Development on Surfing Resources and Recreation (SAS, 2009).

896. Consultation with the local communities and landowners will be undertaken to further understand features of importance for local tourism and recreation.

## 5 PART 5: CONSULTATION

897. This Scoping Report supports the submission to the Planning Inspectorate for the purposes of requesting a Scoping Opinion under the Planning Act 2008 and associated EIA Regulations.
898. Informal consultation will be undertaken with key stakeholders throughout the EIA process to build on the feedback provided in the Scoping Opinion and to further define the scope of studies, surveys and assessments, as required. This will be supported by an Evidence Plan Process for certain topics and issues, as described in **Section 1.6.2**.
899. In line with the requirements of the Planning Act a process of pre-application formal consultation will also be undertaken with prescribed bodies, Local Planning Authorities and people with an interest in the land to which the application relates (under Section 42 of the Planning Act), with local communities (under Section 47) and more widely through the general notification of a proposed application (under Section 48).
900. In accordance with Section 47 of the Planning Act a Statement of Community Consultation (SoCC) will be prepared setting out how the applicant proposes to consult people living in the vicinity about the proposed application, for example through public consultation events. The applicant will make the SoCC available for inspection by the public in a way that is reasonably convenient for people living in the vicinity of the land and also publish a notice stating where and when the SoCC can be inspected.

## 6 PART 6: SUMMARY AND CONCLUSIONS

901. **Table 6-1** summarises the potential impacts for each of the environmental receptors outlined in the sections above. All impacts that have been scoped in for assessment are considered to represent potential likely significant effects under Regulation 10 of the Infrastructure Planning (Environmental Impact Assessment) Regulations 2017.

902. PINS is requested to specifically confirm that the topics listed as scoped out in the table are agreed as scoped out.

*Table 6-1 Summary of impacts scoped in (✓) and out (x)*

Potential impacts	Construction	Operation	Decommissioning
<b>Marine Geology, Oceanography and Physical Processes</b>			
Effects on hydrodynamic regime (waves and tidal currents)	x	✓	✓
Effects on bedload sediment transport	✓	✓	✓
Effects on suspended sediment concentrations and transport	✓	✓	✓
Cumulative impacts	✓	✓	✓
Transboundary impacts	x	x	x
<b>Marine water and sediment quality</b>			
Potential for increases in suspended sediment	✓	x	✓
Potential for the release of contamination	✓	x	✓
Potential for accidental spills and leaks	x	x	x
Cumulative impacts	✓	✓	✓
Transboundary impacts	x	x	x
<b>Benthic and intertidal ecology</b>			
Temporary physical disturbance	✓	✓	✓
Permanent habitat loss	x	✓	✓
Increased suspended sediment concentrations	✓	✓	✓
Re-mobilisation of contaminated sediments	✓	x	✓

Potential impacts	Construction	Operation	Decommissioning
Underwater noise and vibration	✓	x	✓
Colonisation of foundations and cable protection	x	✓	x
Invasive species	x	✓	✓
Potential impacts on sites of marine conservation importance	✓	✓	✓
Impact of electromagnetic fields	x	x	x
Cumulative impacts	✓	✓	✓
Transboundary impacts	x	x	x
<b>Fish and shellfish ecology</b>			
Physical disturbance and temporary loss of sea bed habitat, spawning or nursery grounds during intrusive works	✓	x	✓
Permanent habitat loss	x	✓	x
Increased suspended sediments and sediment re-deposition	✓	✓	✓
Re-mobilisation of contaminated sediment during intrusive works	✓	✓	✓
Underwater noise impacts to acoustically sensitive species during foundation piling	✓	x	x
Underwater noise impacts to acoustically sensitive species due to other activities (vessels, seabed preparation, cable installation etc.)	✓	✓	✓
Introduction of wind turbine foundations, scour	x	✓	x

Potential impacts	Construction	Operation	Decommissioning
protection and hard substrate			
Impacts from electromagnetic fields	x	✓	x
Impacts on commercially exploited species associated with their displacement from the area of activity / works	✓	✓	✓
Cumulative impacts	✓	✓	✓
Transboundary impacts	✓	✓	✓
<b>Marine mammal ecology</b>			
Underwater noise during UXO clearance	✓	x	x
Underwater noise during piling	✓	x	x
Underwater noise from other activities (for example rock placement and cable laying)	✓	✓	✓
Underwater noise and presence of vessels	✓	✓	✓
Underwater noise from operational wind turbines	x	✓	x
Barrier effects from underwater noise	✓	x	✓
Collision risk with vessels	✓	✓	✓
Disturbance at seal haul-out sites	✓	✓	✓
Changes in water quality	✓	✓	✓
Changes to prey availability (including from habitat loss and EMF)	✓	✓	✓
Barrier effects from physical presence of wind farm	x	x	x
Electromagnetic fields direct effects	x	x	x

Potential impacts	Construction	Operation	Decommissioning
Cumulative impacts from underwater noise	✓	✓	✓
Cumulative impacts from collision risk	✓	✓	✓
Cumulative barrier impacts	x	x	X
Cumulative disturbance at seal haul-out sites	✓	✓	✓
Cumulative changes to prey availability (including habitat loss)	✓	✓	✓
Transboundary impacts	✓	✓	✓
<b>Offshore ornithology</b>			
Disturbance and displacement (work activity, vessel movements, presence of turbines and infrastructure, lighting)	✓	✓	✓
Indirect impacts through effects on habitats and prey species	✓	✓	✓
Collision risk with turbines	x	✓	x
Barrier effect due to presence of turbines	x	✓	x
Cumulative impacts (disturbance and displacement, collision and barrier effect)	✓	✓	✓
Transboundary impacts	✓	✓	✓
<b>Commercial fisheries</b>			
Impacts on commercially exploited species associated with their displacement from the area of activity / works	✓	✓	✓
Displacement of fishing activity leading to increased pressure on other areas outside the wind farm sites	✓	✓	✓



Potential impacts	Construction	Operation	Decommissioning
Loss of, or restricted access to, traditional fishing grounds	✓	✓	✓
Loss of, or damage to, fishing gear	✓	✓	✓
Increased collision risk	Included in shipping and navigation assessment	Included in shipping and navigation assessment	Included in shipping and navigation assessment
Increased transit times to reach fishing grounds	✓	✓	✓
Cumulative impacts with other activities	✓	✓	✓
Transboundary impacts	✓	✓	✓
<b>Shipping and navigation</b>			
Displacement of vessel routeing activities	✓	✓	✓
Increased collision risk	✓	✓	✓
Increased allision risk	✓	✓	✓
Interaction with subsea cables	✓	✓	✓
Impacts on emergency response resources	✓	✓	✓
Cumulative impacts	✓	✓	✓
Transboundary impacts	✓	✓	✓
<b>Offshore Archaeology and Cultural Heritage</b>			
Direct, physical, impacts to designated heritage assets.	✓	x	✓
Direct, physical, impacts to non-designated heritage assets.	✓	x	✓
Indirect, physical, impacts to designated heritage assets.	✓	✓	✓
Indirect, physical, impacts to non-designated heritage assets.	✓	✓	✓

Potential impacts	Construction	Operation	Decommissioning
Change to the setting of designated heritage assets, which could affect their heritage significance.	✓	✓	✓
Change to the setting of non-designated heritage assets, which could affect their heritage significance.	✓	✓	✓
Cumulative impacts	✓	✓	✓
Transboundary impacts	✓	✓	✓
<b>Aviation and MoD</b>			
Effects on aviation radar	✓	✓	✓
Risk of aviation collision	✓	✓	✓
Effect on HMRs and offshore platforms	✓	✓	✓
Effects on military training areas	x	✓	x
Cumulative impacts	✓	✓	✓
Transboundary impacts	x	x	x
<b>Air Quality</b>			
Impacts at human receptors	x	x	x
Impacts at ecological receptors	x	x	x
Cumulative impacts	x	x	x
Transboundary impacts	x	x	x
<b>Offshore Designated Sites</b>			
Impacts at human receptors	x	x	x
Impacts at ecological receptors	x	x	x
Cumulative impacts	x	x	x
Transboundary impacts	x	x	x
<b>Other Marine Users</b>			
Potential interference with other wind farms	x	x	x
Potential interference with oil and gas operations	✓	✓	✓

Potential impacts	Construction	Operation	Decommissioning
Potential impacts on subsea cables and pipelines	✓	✓	✓
Impacts on aggregate dredging activities	x	x	x
Impacts on disposal sites	x	x	x
Detonation of UXO	x	x	x
Cumulative impacts	✓	✓	✓
Transboundary impacts	x	x	x
<b>Onshore ground conditions and contamination</b>			
Impacts to human health due to: <ul style="list-style-type: none"> <li>• Disturbance and mobilisation of contaminants from existing sources;</li> <li>• Alterations to exposure pathways; and</li> <li>• Introduction of new contaminant sources.</li> </ul>	✓	x	x
Impacts to controlled waters due to: <ul style="list-style-type: none"> <li>• Disturbance and mobilisation of contaminants from existing sources;</li> <li>• Alterations to exposure pathways; and</li> <li>• Introduction of new contaminant sources.</li> </ul>	✓	x	x
Impact to geologically significant areas and designated geological sites	✓	x	✓
Cumulative impacts	✓	x	✓
Transboundary impacts	x	x	x
<b>Water resources and flood risk</b>			
Direct disturbance of surface water bodies	✓	x	✓
Increased sediment supply	✓	✓	✓
Supply of contaminants	✓	✓	✓

Potential impacts	Construction	Operation	Decommissioning
Changes to surface water runoff and flood risk	✓	✓	✓
Cumulative impacts	✓	✓	✓
Transboundary impacts	x	x	x
<b>Land Use and Agriculture</b>			
Agricultural productivity	✓	✓	✓
Drainage	✓	✓	✓
Disruption to farming practices	✓	✓	✓
Temporary closure of PRowS/cycle paths	✓	x	✓
Existing utilities	✓	x	✓
Permanent loss of land	x	✓	x
Permanent closure/diversion of PRowS	x	✓	x
Soil heating	x	✓	x
Cumulative impacts	✓	✓	✓
Transboundary impacts	x	x	x
<b>Ecology and Ornithology (Including Sites of Nature Conservation Interest)</b>			
Direct impacts to statutory and non-statutory designated nature conservation sites and associated qualifying features	✓	✓	✓
Indirect impacts (e.g. noise, dust, groundwater supply) to statutory and non-statutory designated nature conservation sites and associated qualifying features	✓	✓	✓
Direct impacts (permanent and temporary loss) to habitats due to the footprint of the onshore works	✓	✓	✓
Direct and indirect impacts (disturbance – noise, lighting etc / potential killing)	✓	✓	✓

Potential impacts	Construction	Operation	Decommissioning
to adjacent habitats and protected species			
Spread of invasive non-native species as a result of construction activities	✓	X	✓
Cumulative impacts	✓	✓	✓
Transboundary impacts	✓	✓	✓
<b>Onshore Archaeology and Cultural Heritage</b>			
Direct, physical, impacts to designated heritage assets.	✓	X	✓
Direct, physical, impacts to non-designated heritage assets.	✓	X	✓
Indirect, physical, impacts to designated heritage assets.	✓	✓	✓
Indirect, physical, impacts to non-designated heritage assets.	✓	✓	✓
Change to the setting of designated heritage assets, which could affect their heritage significance.	✓	✓	✓
Change to the setting of non-designated heritage assets, which could affect their heritage significance.	✓	✓	✓
Cumulative impacts	✓	✓	✓
Transboundary impacts	✓	✓	✓
<b>Air Quality</b>			
Generation of dust and particulate matter affecting human and ecological receptors	✓	X	✓
Increases in road traffic emissions affecting human and ecological receptors	✓	X	✓
Cumulative impacts	✓	X	✓
Transboundary impacts	X	X	X

Potential impacts	Construction	Operation	Decommissioning
<b>Noise and Vibration</b>			
Noise affecting human and ecological receptors	✓	✓	✓
Vibration affecting human and ecological receptors	✓	X	✓
Cumulative impacts	✓	✓	✓
Transboundary impacts	X	X	X
<b>Traffic and Transport</b>			
Driver Delay	✓	X	✓
Severance	✓	X	✓
Pedestrian/Cycle amenity	✓	X	✓
Road safety	✓	X	✓
Abnormal loads	✓	X	✓
Onshore traffic associated with the offshore construction	X	X	X
Cumulative impacts	✓	X	✓
Transboundary impacts	X	X	X
<b>Seascape, Landscape and Visual</b>			
Impacts of the offshore works on seascape / landscape character and visual amenity	✓	✓	✓
Impacts of the offshore works on seascape, landscape and visual receptors	✓	✓	✓
Impacts of the offshore works on the landscape character of the Norfolk and Suffolk Broads National Park	X	X	X
Impacts of the onshore works on landscape character and visual amenity	✓	✓	✓



Potential impacts	Construction	Operation	Decommissioning
Impacts of the onshore works on landscape and visual receptors	✓	✓	✓
Cumulative impacts with other offshore projects	✓	✓	✓
Cumulative impacts with other onshore projects	✓	✓	✓
<b>Socio-Economics</b>			
Direct economic benefit	✓	✓	✓
Increased employment	✓	✓	✓
Change in demographics due to in-migration	x	✓	x
Loss of or disruption to local infrastructure	✓	✓	✓
Disturbance (noise, air, visual, and traffic) to social infrastructure	✓	✓	✓
Pressure on local health infrastructure (doctors' surgeries / hospitals / dentists)	✓	✓	✓
Cumulative socio-economic impacts	✓	✓	✓
<b>Health</b>			
Noise disturbance	✓	✓	✓
Emissions to air (including dust)	✓	x	✓
Exposure to contaminated soils	✓	x	✓
Accidental / incidental chemical spills / leaks to surface / ground / coastal waters or soils	✓	x	✓
Increased Flood Risk	✓	✓	✓
Navigation Risk	✓	✓	✓
Obstruction to or loss of open space and associated health benefits	✓	✓	✓

Potential impacts	Construction	Operation	Decommissioning
Disruption to local road network (reduced access to services and amenities)	✓	✓	✓
Transport related accidents	✓	✓	✓
Community stress and anxiety as a result of increased pollution (water) risk, flood risk, noise, visual, heavy traffic, or crime due to in-migrant workers	✓	✓	✓
Loss of or pressure on existing healthcare services	✓	✓	✓
Cumulative impacts	✓	✓	✓
Transboundary impacts	X	X	X
<b>Tourism and Recreation</b>			
<b>Coastal and marine</b>			
Visual impacts	✓	✓	✓
Disruption to marine and coastal recreational activities	✓	✓	✓
Restricted beach access	✓	X	✓
Deterioration to Bathing water / Blue flag beaches and resulting effect on tourism and recreation	✓	X	✓
<b>Onshore (inland)</b>			
Visual impacts	✓	✓	✓
Loss of and disturbance to local tourism and recreation assets	✓	X	✓
Alternate routes / temporary/permanent closure of PRoWs	✓	✓	✓
Disturbance to recreation / tourism assets from noise, dust and visual impact	✓	X	✓

Potential impacts	Construction	Operation	Decommissioning
Reduction in available accommodation due to construction personnel	✓	✓	✓
Cumulative impacts	✓	✓	✓

## 7 REFERENCES

Ashwin, T. and Bates, S., (2000). Excavations on the Norwich Southern Bypass, 1989–91 Part I: Excavations at Bixley, Caistor St Edmund, Trowse, Cringleford and Little Melton, East Anglian Archaeology 91

Band, W. (2012) SOSS-02: Using a Collision Risk Model to Assess Bird Collision Risks For Offshore Wind Farms (No. SOSS-02).

Bat Conservation Trust and Institute of Lighting Engineers (2018) Bats and Artificial Lighting in the UK;

BEIS (2018). Record of The Habitats Regulations Assessment Undertaken Under Regulation 65 of The Conservation of Habitats and Species (2017), and Regulation 33 of The Conservation of Offshore Marine Habitats and Species Regulations (2017). Review of Consented Offshore Wind Farms in the Southern North Sea Harbour Porpoise SCI.

BERR (2008). Review of Cabling Techniques and Environmental Effects applicable to the Offshore Windfarm Industry

Bing OS Maps (undated). (Online) Available from: [www.bing.com/maps](http://www.bing.com/maps) (Accessed: 16/07/19)

Blyth-Skyrme, R. E. (2010) Options and opportunities for marine fisheries mitigation associated with wind farms. Final report for Collaborative Offshore Wind Research into the Environment contract FISHMITIG09. COWRIE Ltd, London. 125 pp.

BMAPA (2009) Renewable Energy & Cables. Dredger transit routes (Online) Available from the British Marine Aggregate Producers Association (BMAPA) website: [https://bmapa.org/issues/renewable\\_energy.php](https://bmapa.org/issues/renewable_energy.php)

Bochert & Zettler (2006) Effect of Electromagnetic Fields on Marine Organisms. Chapter 14 in Offshore Wind Energy; Research on Environmental Impacts

Brasseur S., Cremer J., Czeck R., Galatius A., Jeß A., Körber P., Pund R., Siebert U., Teilmann J. and Klöpper S. (2018). TSEG grey seal surveys in the Wadden Sea and Helgoland in 2017-2018. Common Wadden Sea Secretariat, Wilhelmshaven, Germany.

British Geological Survey (undated) Online Viewer. (Online) Available from: <https://www.bgs.ac.uk/geoindex/>

British Standards Institution (2013) 42020:2013 – Biodiversity. Code of Practice for planning and development;

British Standard (2017) BS10175:2011 +A2:2017 Investigation of Potentially Contaminated Sites. Code of Practice

British Standards Institution (1991) BS7445-2:1991 - Description and measurement of environmental noise. Guide to the acquisition of data pertinent to land use. London, BSI.

British Standards Institution (2003) BS EN 61672-1:2003 Electroacoustics. Sound level meters. Specifications. London, BSI.

British Standards Institution (2003) BS7445-1:2003 - Description and measurement of environmental noise. Guide to quantities and procedures. London, BSI.

British Standards Institution (2008) BS6472-1:2008 Guide to evaluation of human exposure to vibration in buildings. Part 1: Vibration sources other than blasting. London, BSI.

British Standards Institution (2014) BS4142:2014 Methods for rating and assessing industrial and commercial sound. London, BSI.

British Standards Institution (2014a) BS5228-1:2009+A1:2014 “Code of practice for noise and vibration control on construction and open sites – Part 1: Noise”. London, BSI.

British Standards Institution (2014b) BS5228-2:2009+A1:2014 “Code of practice for noise and vibration control on construction and open sites – Part 2: Vibration”. London, BSI.

British Standards Institution (2014c) BS8233: Sound Insulation and Noise Reduction for Buildings. London, BSI.

Broadland District Council (2014) Joint Core Strategy for Broadland, Norwich and South Norfolk. Available from: [https://www.broadland.gov.uk/downloads/file/1310/joint\\_core\\_strategy\\_adopted\\_document\\_2014uk](https://www.broadland.gov.uk/downloads/file/1310/joint_core_strategy_adopted_document_2014uk) (Accessed: 31/07/19).

Brown, A., Russell, J., Scaife, R., Tizzard, L., Whittaker, J. and Wyles, S. F. (2018) Lateglacial/early Holocene palaeoenvironments in the southern North Sea Basin: new data from the Dudgeon offshore wind farm. *Journal of Quaternary Science* 33 (6) 6 August 2018 pp. 597-610.

BSI (2015). Environmental Impact Assessment for offshore renewable energy project – guide. PD 6900:2015.

CAA (2016) CAP 393 The air Navigation: Order 2019 and the Regulations

CAA (2016) CAP 764 Policy and Guideline on Wind Turbines

CAA (2017) Visual Flight Rules Chart

CAA (2018) CAP 032 UK Integrated Aeronautical Information Package (UKIAIP)

CAA (2014) CAP 670 Air Traffic Services Safety Requirements

CAA, VFR (2017) Visual Flight Rules Chart- lower airspace rules

Cefas (2011) Guidelines for Data Acquisition to Support Marine Environmental Assessments of Offshore Renewable Energy Projects.

Cefas (2015) Cromer Shoal Chalk Beds rMCZ Post-survey Site Report (Online) Available from:

[http://randd.defra.gov.uk/Document.aspx?Document=12825\\_Cromer\\_Shoal\\_Chalk\\_Beds\\_rMCZ\\_SummarySiteReport\\_v5.pdf](http://randd.defra.gov.uk/Document.aspx?Document=12825_Cromer_Shoal_Chalk_Beds_rMCZ_SummarySiteReport_v5.pdf)

Cefas (2004) Offshore Wind Farms: Guidance Note for Environmental Impact Assessment in respect of Food and Environmental Protection Act (FEPA) and Coast Protection Act (CPA) requirements: Version 2

Centre for Ecology and Hydrology (2019) Air Pollution Information System. (Online) Available from: <http://www.apis.ac.uk/>

Centre for Economics and Business Research (CEBR) (2012). Economic Impact of Offshore Wind. (Online) Available from: <http://www.cebr.com/reports/economic-impact-of-offshore-wind/>

Chartered Institute of Ecology and Environmental Management (CIEEM) (2018) Guidelines for Ecological Impact Assessment in the UK and Ireland: Terrestrial, Freshwater and Coastal.

Cheesman, S. (2016) Measurements of operational wind turbine noise in UK waters. In *The Effects of Noise on Aquatic Life II* (pp. 153-160). Springer, New York, NY

ClfA (2014) Code of Conduct. Reading, University of Reading.

ClfA (2017) Standard and guidance for historic environment desk-based assessment. Reading, University of Reading

CIRIA (2007) C665 Assessing Risks Posed by Hazardous Ground Gases to Buildings

CIRIA Guidance note C692 Environmental Good Practice on Site Guide (3rd Edition)

Cleasby, I.R., Owen, E., Wilson, L.J., Bolton, M., (2018) Combining habitat modelling and hotspot analysis to reveal the location of high density seabird areas across the UK (Research Report No. 63). RSPB Centre for Conservation Science.

Committee on Climate Change (2015) Reducing emissions and preparing for climate change: 2015 Progress Report to Parliament.

Collier, M.P., Burton, N.H.K., Thaxter, C.B., Clark, N.A., Wright, L.J., Fijn, R.C., (2016) Tracking breeding Sandwich terns on the North Norfolk Coast: Fieldwork report 2016 (No. 16–129). Bureau Waardenburg bv, Culemborg.

Collier, M.P., Scragg, E., Fijn, R.C. (2017) Tracking breeding Sandwich terns on the North Norfolk Coast: Fieldwork report 2017 (No. 17–150). Bureau Waardenburg bv, Culemborg.

Collier, M.P., Taylor, R.C., Scragg, E.S., Fijn, R.C. (2018) Tracking breeding Sandwich terns on the North Norfolk Coast: Fieldwork report 2018 (No. 18–239). Bureau Waardenburg bv, Culemborg.

Committee on Climate Change (2015) The Fifth Carbon Budget: The next step towards a low-carbon economy. (Online) Available from: <https://www.theccc.org.uk/wp-content/uploads/2015/11/Committee-on-Climate-Change-Fifth-Carbon-Budget-Report.pdf> (Accessed: 05/08/2019)



Coull, K.A., Johnstone, R., and S.I. Rogers (1998) Fisheries Sensitivity Maps in British Waters

COWRIE (2009) Coastal Process Modelling for Offshore Windfarm Environmental Impact Assessment

Climate Science Special Report (CSSR) (2017) Climate Science Special Report (Online) Available from: <https://science2017.globalchange.gov/>

Dean et al. (2016) The Water Vole Mitigation Handbook (The Mammal Society Guidance Series);

DECC (2009) UK Offshore Energy Strategic Environmental Assessment (OESEA).

DECC (2011a) Overarching National Policy Statement for Energy (EN-1).

DECC (2011b) National Policy Statement for Renewable Energy Infrastructure (EN-3).

DECC (2011c) National Policy Statement for Electricity Networks Infrastructure (EN-5).

DECC (2012) Record of the Appropriate Assessment Undertaken for Applications Under Section 36 of the Electricity Act 1989: Docking Shoal Offshore Wind Farm (as amended), Race Bank Offshore Wind Farm (as amended), Dudgeon Offshore Wind Farm. DECC.

DECC (2016). UK Offshore Energy Strategic Environmental Assessment 3 (OESEA3).

DECC (2016). UK Offshore Energy Strategic Environmental Assessment, OESEA3, Post Consultation Report, July 2016

DECC (2019) Digest of UK Energy Statistics 2019

DEFRA (1990) Environmental Protection Act 1990: Part 2A, Contaminated Land Statutory Guidance

DEFRA (2009) Construction Code of Practice for the Sustainable Use of Soils on Construction Sites

DEFRA (2010) Guidance on the duties on public authorities in relation to Marine Conservation Zones. Guidance on the duties which will be placed on public authorities in relation to Marine Conservation Zones under Part 5 of the Marine and Coastal Access Act 2009. Dated November 2010.

DEFRA (2014) Charting Progress 2. The State of UK Seas. (Online) Available from: <https://webarchive.nationalarchives.gov.uk/20141203170558/http://chartingprogress.defra.gov.uk/>

DEFRA (2016) Local Air Quality Management Technical Guidance LAQM.TG(16).

Department for Environment, Food and Rural Affairs (DEFRA) (2016) Cromer Shoal Chalk Beds Marine Conservation Zone. (Online). Available from: [https://assets.publishing.service.gov.uk/government/uploads/system/uploads/attachment\\_data/file/492323/mcz-cromer-shoal-chalk-beds-factsheet.pdf](https://assets.publishing.service.gov.uk/government/uploads/system/uploads/attachment_data/file/492323/mcz-cromer-shoal-chalk-beds-factsheet.pdf)

DEFRA (undated) MAGIC map. (Online) Available from: [www.magic.defra.gov.uk](http://www.magic.defra.gov.uk) (Accessed 16/07/2019)

DEFRA and Environment Agency (2004) Model Procedures for the Management of Contaminated Land, R & D Publication CLR11

DEFRA and Environment Agency (2016) Anglian river basin district river basin management plan

DEFRA Biodiversity Metric calculation tool, user guide and technical supplement (Version 2.0) (2019)

Department for Transport (2015) Transport Analysis Guidance UA3: Environmental Impact Appraisal.

Department for Transport, Welsh Office (1988) Calculation of Road Traffic Noise. London, HMSO.

Diederichs, A., Nehls, G., Dähne, M., Adler, S., Koschinski, S. and Verfuß, U. (2008). Methodologies for measuring and assessing potential changes in marine mammal behaviour, abundance or distribution arising from the construction, operation and decommissioning of offshore windfarms. Commissioned by COWRIE Ltd, 231.

Dudgeon Offshore Wind Limited (DOW) (2009) Dudgeon Offshore Wind Farm Environmental Statement

EC (2008). 56/EC of the European Parliament and of the Council of 17 June 2008 establishing a framework for community action in the field of marine environmental policy (Marine Strategy Framework Directive). OJEC L, 164, p.40.

Edgar et al. (2010) Reptile Habitat Management Handbook

Ellis, J.R., Milligan, S.P., Readdy, L., Taylor, N. and Brown, M.J. (2012) Spawning and nurserygrounds of selected fish species in UK waters. Sci. Ser. Tech. Rep., Cefas Lowestoft, 147: 56

EMODnet EUSeaMap (2019) Broad-Scale Predictive Habitat Map - EUNIS classification. (Online) Available from: <http://gis.ices.dk/geonetwork/srv/eng/catalog.search#/metadata/01bf1f24-fdcd-4ee7-af8b-e62cf72fe2f9>

English Nature (2001) Great Crested Newt Mitigation Guidelines

Environment Agency (2012) Flood zone maps. (Online) Available from: <https://flood-map-for-planning.service.gov.uk/> (Accessed 17/07/2019)

Environment Agency (2019a). Catchment Data Explorer. Data available online at: <https://environment.data.gov.uk/catchment-planning/>

Environment Agency (2019b). Bathing Water quality. Available from: <https://environment.data.gov.uk/bwq/profiles/>

Environmental Protection Act (1990). London, HMSO.

Equinor (2019) Dudgeon OWF – ST18692. Environmental Post Construction Survey Report. North Sea. August – September 2018.

Fijn, R.C., Gyimesi, A. (2018) Behaviour related flight speeds of Sandwich Terns and their implications for wind farm collision rate modelling and impact assessment. *Environmental Impact Assessment Review* 71, 12–16. <https://doi.org/10.1016/j.eiar.2018.03.007>

FLOWW (2014) Best Practice Guidance for Offshore Renewables Developments. Recommendations for Fisheries Liaison. FLOWW (Fishing Liaison with Offshore Wind and Wet Renewables Group).

FLOWW (2015) Best Practice Guidance for Offshore Renewables Developments: Recommendations for Fisheries Disruption Settlements and Community Funds. FLOWW (Fishing Liaison with Offshore Wind and Wet Renewables Group).

Fugro (2015) ST14916 Dudgeon Offshore Wind Farm Development Pre-construction Baseline ecology Study. Fugro EMU Report No: 14/J/1/03/2326/1780. Statoil Report No: C177-FUG-U-RA-0002.

Galatius, A., Brasseur, S., Cremer, J., Czeck, R., Jeß, A., Körber, P., Pund, R., Siebert, U., Teilmann, J. and Klöpffer, S. (2018). Aerial surveys of Harbour Seals in the Wadden Sea in 2018. Common Wadden Sea Secretariat, Wilhelmshaven, Germany.

GB Non-native Species Secretariat (2015) Species Information.

Gibb N, Tillin H, Pearce B. & Tyler-Walters H. (2014) Assessing the sensitivity of *Sabellaria pinulosa* reef biotopes to pressures associated with marine activities

Gill A., Gloyne-Phillips, I., Neal, K. and Kimber, J. (2005). The potential effects of electromagnetic fields generated by sub-sea power cables associated with offshore wind farm developments on electrically and magnetically sensitive marine organisms – a review. Report to Collaborative Offshore Wind Research into the Environment (COWRIE) group, Crown Estates.

Gill, A. B. and Bartlett, M. (2010) Literature review on the potential effects of electromagnetic fields and subsea noise from marine renewable energy developments on Atlantic salmon, sea trout and European eel. Scottish Natural Heritage, Commissioned Report No. 401.

Gilles, A., Peschko, V., Scheidat, M. and Siebert, U. (2012). Survey for small cetaceans over the Dogger Bank and adjacent areas in summer 2011. Document submitted by Germany to 19th ASCOBANS Advisory Committee Meeting in Galway, Ireland, 20-22 March 2012. AC19/Doc.5-08(P). 16pp.

Gilles, A., Viquerat, S., Becker, E. A., Forney, K. A., Geelhoed, S. C. V., Haelters, J., Nabe-Nielsen, J., Scheidat, M., Siebert, U., Sveegaard, S., van Beest, F. M., van Bemmelen, R. and Aarts, G. (2016). Seasonal habitat-based density models for a marine top predator, the harbour porpoise, in a dynamic environment. *Ecosphere* 7(6): e01367. [10.1002/ecs2.1367](https://doi.org/10.1002/ecs2.1367).

Google Earth (2018). (Online) Available from: <https://earth.google.com/web>

Gubbay (2007) Defining and managing Sabellaria spinulosa reefs: Report of an inter-agency workshop 1-2 May 2007; June 2007. JNCC Report No. 405

Hammond, P.S., Lacey, C., Gilles, A., Viquerat, S., Boerjesson, P., Herr, H., Macleod, K., Ridoux, V., Santos, M., Scheidat, M. and Teilmann, J. (2017). Estimates of cetacean abundance in European Atlantic waters in summer 2016 from the SCANS-III aerial and shipboard surveys. Wageningen Marine Research.

Harwood, A.J.P., Perrow, M.R., Berridge, R.J., Tomlinson, M.L. (2018) Ornithological monitoring during the construction and operation of Sheringham Shoal Offshore Wind Farm: February 2009 – February 2016 inclusive. ECON Ecological Consultancy Ltd.

Heinänen, S. and Skov, H. (2015). The identification of discrete and persistent areas of relatively high harbour porpoise density in the wider UK marine area, JNCC Report No.544 JNCC, Peterborough.

Highways Agency (2001) Design Manual for Roads and Bridges, Volume 11, Section 3, Part 6 – Land Use.

Highways Agency (2008) Design Manual for Roads and Bridges, Volume 11 Environmental Assessment, Section 2 Environmental Impact Assessment, Part 5 Assessment and management of environmental effects. HA205/08.

Highways Agency (2011) Design Manual for Roads and Bridges, Volume 11, Section 3, Part 7: Noise and Vibration. The Highways Agency.

Highways Agency (now Highways England) (2007) Design Manual for Roads and Bridges HA207/07 Air Quality

Historic England (2013) Marine Geophysics Data Acquisition, Processing and Interpretation. Guidance prepared by Plets, R., Dix, J., Bates, R. (Online) Available from: <https://content.historicengland.org.uk/images-books/publications/marine-geophysics-data-acquisition-processing-interpretation/MGDAPAI-guidance-notes.pdf/> (Accessed: 18/07/2019}

Historic England (2015a) The Historic Environment in Local Plans. Historic Environment Good Practice Advice in Planning: 1

Historic England (2015b) Making Significance in Decision-Taking in the Historic Environment. Historic Environment Good Practice Advice in Planning: 2.

Historic England (2017) The Setting of Heritage Assets (2nd Edition). Historic Environment Good Practice Advice in Planning: 3.

HM Government (2009). The UK Low Carbon Transition Plan; National strategy for climate and energy

HM Government (2011). Marine Policy Statement. Available from: [https://www.gov.uk/government/uploads/system/uploads/attachment\\_data/file/69322/pb3654-marine-policy-statement-110316.pdf](https://www.gov.uk/government/uploads/system/uploads/attachment_data/file/69322/pb3654-marine-policy-statement-110316.pdf).

HM Government (2014). East Inshore and East Offshore Marine Plans.

HM Government (2016). Andrea Leadsom Speech to Utility Week Energy Summit. (Online) Available from: <https://www.gov.uk/government/speeches/andrea-leadsom-speech-to-utility-week-energy-summit>. (Accessed 05/08/2019)

HM Government (2017). Green Paper: Building our Industrial Strategy (Online) Available from: [https://beisgovuk.citizenspace.com/strategy/industrial-strategy/supporting\\_documents/buildingourindustrialstrategygreenpaper.pdf](https://beisgovuk.citizenspace.com/strategy/industrial-strategy/supporting_documents/buildingourindustrialstrategygreenpaper.pdf) (Accessed 05/08/2019)

HR Wallingford, 2006. Sheringham Shoal Wind farm: Coastal and seabed processes. HRW Report EX5117.

IAMMWG (2015). Management Units for cetaceans in UK waters (January 2015). JNCC Report No. 547, JNCC Peterborough.

IAQM (2019) A Guide to the Assessment of Air Quality Impacts on Designated Nature Conservation Sites;

IAQM and Environmental Protection UK (EPUK) (2017) Land-Use Planning and Development Control: Planning for Air Quality;

IMO (2018) Revised Guidelines for Formal Safety Assessment (FSA) for use in the IMO Rule Making Process. MSC-MEPC.2/Circ.12/Rev.2. April 2018

Independent Oil and Gas (2019). Blyth. Available on website: <https://www.independentoilandgas.com/blythe.php>

Institute of Air Quality Management (IAQM) (2014) Guidance on the Assessment of Dust from Demolition and Construction;

Institute of Environmental Assessment (1993) Guidelines for the Environmental Assessment of Road Traffic (GEART)

Institute of Environmental Management and Assessment (2014) Guidelines for Environmental Noise Impact Assessment. Lincoln, IEMA.

International Organization for Standardization (1996) ISO9613-2:1996 Acoustics – Attenuation of sound during propagation outdoors – Part 2: General method of calculation. Switzerland, ISO.

Irving, R (2009) The identification of the main characteristics of stony reef habitats under the Habitats Directive. Peterborough, UK: Joint Nature Conservation Committee.

JNCC (2010a). Statutory nature conservation agency protocol for minimising the risk of injury to marine mammals from piling noise. August 2010.

JNCC (2010b). JNCC guidelines for minimising the risk of injury to marine mammals from using explosives. August 2010.

JNCC (2014) EUNIS Level 3 Seabed habitat map integrating data originating from maps from field surveys and the EUSeaMap model. (Online) Available from: [http://archive.jncc.gov.uk/pdf/20140311\\_InformationSheet\\_combinedEUNISL3map\\_v1.pdf](http://archive.jncc.gov.uk/pdf/20140311_InformationSheet_combinedEUNISL3map_v1.pdf)



JNCC (2016) Annex I Sandbanks in the UK. (Online) Available from: [http://archive.jncc.gov.uk/PDF/P20161217\\_InformationSheet\\_AnnexI Sandbanks.pdf](http://archive.jncc.gov.uk/PDF/P20161217_InformationSheet_AnnexI Sandbanks.pdf)

JNCC (2019) *Nephtys cirrosa* and *Bathyporeia* spp. in infralittoral sand - JNCC Marine Habitat Classification. (Online) Available from: <https://mhc.jncc.gov.uk/biotopes/JNCCMNCR00000785> (Accessed 26 Jul. 2019).

JNCC, Natural England and CCW (2010). Draft EPS Guidance - The protection of marine European Protected Species from injury and disturbance. Guidance for the marine area in England and Wales and the UK offshore marine area. Joint Nature Conservation Committee, Natural England and Countryside Council for Wales. October 2010.

Johnston, A., Cook, A.S.C.P., Wright, L.J., Humphreys, E.M., Burton, N.H.K. (2014a) Modelling flight heights of marine birds to more accurately assess collision risk with offshore wind turbines. *Journal of Applied Ecology* 51, 31–41. <https://doi.org/10.1111/1365-2664.12191>

Johnston, A., Cook, A.S.C.P., Wright, L.J., Humphreys, E.M., Burton, N.H.K. (2014b) Corrigendum. *Journal of Applied Ecology* 51, 1126–1130. <https://doi.org/10.1111/1365-2664.12191>

JNCC (2003) Herpetofauna Worker's Manual;

KIS-ORCA (2019) Offshore map. Kingfisher Information Service - Offshore Renewable & Cable Awareness project (KIS-ORCA). (Online) Available from: <http://www.kis-orca.eu/map#.XVKiruhKiUk>.

Landmark Envirocheck (2019). (Online) Available from: <http://www.envirocheck.co.uk/>

Landscape Institute (2011). Landscape Institute Advice Note 01/11, Photography and photomontage in landscape and visual impact assessment

Landscape Institute and Institute of Environmental Management and Assessment (2013) Guidelines for Landscape and Visual Impact Assessment: Third Edition, London: Routledge.

Lindeboom, H.J., Kouwenhoven, H.J., Bergman, M.J.N., Bouma, S., Brasseur, S., Daan, Fijn, R.C., de Haan, D., Dirksen, S., van Hal, R, Hille Ris Lambers, R, ter Hofstede, Krijgsveld, R.K.L., Leopold, M. and Scheidat, M. (2011). Short-term ecological effects of an offshore wind farm in the Dutch coastal zone; a compilation. *Environ. Res. Lett.* 6 (3).

LUC (2017a) National Historic Seascape Characterisation (NHSC): Technical Advice Document. (Online) Available from: [http://archaeologydataservice.ac.uk/archiveDS/archiveDownload?t=arch-2958-1/dissemination/pdf/National\\_HSC\\_Database\\_Technical\\_Advice\\_Document.pdf](http://archaeologydataservice.ac.uk/archiveDS/archiveDownload?t=arch-2958-1/dissemination/pdf/National_HSC_Database_Technical_Advice_Document.pdf) (Accessed 17/07/2019)

LUC (2017b) National Historic Seascape Characterisation (NHSC): User Guide. (Online) Available from:



[http://archaeologydataservice.ac.uk/archiveDS/archiveDownload?t=arch-2958-1/dissemination/pdf/National\\_HSC\\_Database\\_User\\_Guide.pdf](http://archaeologydataservice.ac.uk/archiveDS/archiveDownload?t=arch-2958-1/dissemination/pdf/National_HSC_Database_User_Guide.pdf) (Accessed 17/07/2019)

LUC (2017c) Historic Seascape Characterisation (HSC): Consolidating the National HSC Database. (Online) Available from: [http://archaeologydataservice.ac.uk/archiveDS/archiveDownload?t=arch-2958-1/dissemination/pdf/Consolidating\\_the\\_National\\_HSC\\_Database\\_Project\\_Report\\_-\\_Final\\_Report.pdf](http://archaeologydataservice.ac.uk/archiveDS/archiveDownload?t=arch-2958-1/dissemination/pdf/Consolidating_the_National_HSC_Database_Project_Report_-_Final_Report.pdf) (Accessed: 17/07/2019)

Lucke, K., Siebert, U., Lepper, P. A. and Blanchet, M. A. (2009). Temporary shift in masked hearing thresholds in a harbor porpoise (*Phocoena phocoena*) after exposure to seismic airgun stimuli. J. Acoust. Soc. Am., 125 (6), pp. 4060-4070.

Marine Scotland (2012). Marine Scotland Offshore Renewables Research: Work Package A3: Request for advice about the displacement of marine mammals around operational offshore windfarms. Available from: <http://www.gov.scot/Resource/0040/00404921.pdf>.

MARINELife (2019). Marine mammal sightings from southern North Sea ferry routes, (Online), Available from: <http://www.marine-life.org.uk/sightings>

MarLIN (2019) MarLIN - The Marine Life Information Network - UK Marine habitat classification (04.05) list. (Online) Available from: <https://www.marlin.ac.uk/habitats/biotopes> (Accessed 26 Jul. 2019).

MarLIN (2019b) MarLIN - The Marine Life Information Network - *Nephtys cirrosa* and *Bathyporeia* spp. in infralittoral sand. (Online) Available from: [https://www.marlin.ac.uk/habitats/detail/154#policy\\_legislation](https://www.marlin.ac.uk/habitats/detail/154#policy_legislation) (Accessed 26 Jul. 2019).

MCA (2008) MGN 543 Safety of Navigational Practice, Safety and Emergency Response

MCA (2008) Offshore Renewable Energy Installations (OREIs): Guidance to Mariners Operating in the Vicinity of UK OREIs (M+F). August 2008

MCA (2015) Methodology for Assessing the Marine Navigational Safety Risks of Offshore Renewable Energy Installations

MCA (2016) MGN 543 (M+F): Safety of Navigation: Offshore Renewable Energy Installations (OREIs) – Guidance on UK Navigational Practice, Safety and Emergency Response. February 2016

McConnell, B., Lonergan, M. and Dietz, R. (2012). Interactions between seals and offshore wind farms. The Crown Estate. ISBN: 978-1-906410-34-5.

McGregor, R.M., King, S., Donovan, C.R., Caneco, B., Webb, A. (2018) A Stochastic Collision Risk Model for Seabirds in Flight. Marine Scotland.

Ministry of Housing, Communities & Local Government (2018) Conserving and enhancing the historic environment. Planning Practice Guidance.

Ministry of Housing, Communities & Local Government (2018) National Planning Policy Framework. London, OGL.

Ministry of Housing, Communities & Local Government (2019) Planning Practice Guidance. London, OGL. (Online) Available from: <https://www.gov.uk/guidance/noise--2> (Accessed 29/07/19).

Ministry of Housing, Communities and Local Government (2014) Planning Practice Guidance: Flood Risk and Coastal Change. (Online) Available from: <https://www.gov.uk/guidance/flood-risk-and-coastal-change> (Accessed 19/07/2019)

MMO (2013) Marine conservation zones and marine licensing. Dated April 2013.

MMO (2014) Mapping UK Shipping Density and Routes from AIS. A report produced for the Marine Management Organisation, pp 35. MMO Project No: 1066. ISBN: 978-1-909452-26-8.

MMO (2014) Review of environmental data associated with post-consent monitoring of licence conditions of offshore wind farms. (Online) Available from: [https://assets.publishing.service.gov.uk/government/uploads/system/uploads/attachment\\_data/file/317787/1031.pdf](https://assets.publishing.service.gov.uk/government/uploads/system/uploads/attachment_data/file/317787/1031.pdf) (Accessed 17/07/2019)

MMO (2014). Marine Licensing: sediment analysis and sample plans. Guidance. (Online) Available from: <https://www.gov.uk/guidance/marine-licensing-sediment-analysis-and-sample-plans###Suitability%20of%20material>

MMO (2017) Anonymised AIS Derived Track Lines 2015. (Online) Available from: <https://data.gov.uk/dataset/963c1a7b-5b72-4cce-93f5-3f1e223fd575/anonymised-ais-derived-track-lines-2015>

MMO (2018) UK sea fisheries annual statistics report 2017. (Online) Available from: <https://www.gov.uk/government/statistics/uk-sea-fisheries-annual-statistics-report-2017> (Accessed 16/07/2019)

Moan, P. (2018) Archaeological Excavations along the Norwich Northern Distributor Road, Norfolk. Oxford Archaeology East Grey Literature Report (Unpublished).

MoD (2011) MoD UK Low-Flying System (UK FLS) Priority Map

MoD (2014) MoD Obstruction Lighting Guidance

Moriarty, M., Greenstreet, S (2017) Greater North Sea International Otter Trawl Quarter 3 Groundfish Survey Monitoring and Assessment Data Products

National Air Traffic Services (NATS) (2015) East Anglia Tranche 1 North Technical and Operational Assessment (TOPA).

National Marine Fisheries Service (NMFS) (2018). Revisions to: Technical guidance for Assessing the Effects of Anthropogenic Sound on Marine Mammal Hearing (Version 2.0): Underwater Thresholds for Onset of Permanent and Temporary Threshold Shifts. U.S. Dept of Commer., NOAA. NOAA Technical Memorandum NMFS-OPR-59.

Natural England (2012) NE124 – Look after your land with Environmental Stewardship

Natural England (2015) Standing advice on protected species (bats (all species), great crested newt *Triturus cristatus*, badger, water vole *Arvicola amphibius*, otter *Lutra lutra*, reptiles, protected plants, invertebrates, white-clawed crayfish *Austropotamobius pallipes*, ancient woodlands and veteran trees);

Natural England / Department for Environment, Food and Rural Affairs. (2014) Landscape and Seascape Character Assessments.

Natural England (2019). Net Gain for intertidal environments. Draft guidance dated April 2019.

NOMIS Norfolk County Local Area Report. (Online) Available from: <https://www.nomisweb.co.uk/reports/localarea?compare=E10000020> (Accessed 30/06/2019)

Norfolk Boreas Limited (2019) Norfolk Boreas Offshore Wind Farm Environmental Statement

Norfolk Insight Overview (2019). (Online) Available from: [www.norfolkinsight.org.uk](http://www.norfolkinsight.org.uk) (Accessed 30/06/19)

Norfolk Vanguard Limited (2018). Norfolk Vanguard Offshore Wind Farm Chapter 12 Marine Mammals: Environmental Statement Volume 1.

Normandeau, Exponent, Tricas, T. and Gill, A. (2011). Effects of EMFs from Undersea Power Cables on Elasmobranchs and Other Marine Species. OCS Study BOEMRE 2011-09, U.S. Department of the Interior, Bureau of Ocean Energy Management, Regulation, and Enforcement, Pacific OCS Region, Camarillo, California. Available from: <https://www.boem.gov/Environmental-Stewardship/Environmental-Studies/Pacific-Region/Studies/2011-09-EMF-Effects.aspx>

Office for National Statistics. (2018). (Online) Available from: [www.ons.gov.uk](http://www.ons.gov.uk) (Accessed 31/07/2019)

Office of the Deputy Prime Minister, 2001. Guidance on Environmental Impact Assessment in Relation to Dredging Applications

Offshore Renewable Energy (ORE) Catapult2017. Cost Reduction Monitoring Framework 2016. Summary Report to the Offshore Wind Programme Board. (Accessed 05/08/2019)

Oppel, S., Bolton, M., Carneiro, A.P.B., Dias, M.P., Green, J.A., Masello, J.F., Phillips, R.A., Owen, E., Quillfeldt, P., Beard, A., Bertrand, S., Blackburn, J., Boersma, P.D., Borges, A., Broderick, A.C., Catry, P., Cleasby, I., Clingham, E., Creuwels, J., Crofts, S., Cuthbert, R.J., Dallmeijer, H., Davies, D., Davies, R., Dilley, B.J., Dinis, H.A., Dossa, J., Dunn, M.J., Efe, M.A., Fayet, A.L., Figueiredo, L., Frederico, A.P., Gjerdrum, C., Godley, B.J., Granadeiro, J.P., Guilford, T., Hamer, K.C., Hazin, C., Hedd, A., Henry, L., Hernández-Montero, M., Hinke, J., Kokubun, N., Leat, E., Tranquilla, L.M., Metzger, B., Militão, T., Montrond, G., Mullié, W., Padget, O., Pearmain, E.J., Pollet, I.L., Pötz, K., Quintana, F., Ratcliffe, N., Ronconi, R.A., Ryan, P.G., Saldanha, S., Shoji, A., Sim, J., Small, C., Soanes, L., Takahashi, A., Trathan, P., Trivelpiece, W., Veen, J., Wakefield, E., Weber, N., Weber, S., Zango, L., Daunt, F., Ito, M., Harris, M.P., Newell,

M.A., Wanless, S., González-Solís, J., Croxall, J. (2018) Spatial scales of marine conservation management for breeding seabirds. *Marine Policy* 98, 37–46. <https://doi.org/10.1016/j.marpol.2018.08.024>

ORE Catapult (2017) Impact Report 2016/17 (Online) Available from: <https://ore.catapult.org.uk/app/uploads/2017/11/IMPACT-REPORT-2016-17-FINAL.pdf>

Paxton, C.G.M., Scott-Hayward, L., Mackenzie, M., Rexstad, E. and Thomas, L. (2016). Revised Phase III Data Analysis of Joint Cetacean Protocol Data Resources with Advisory Note, JNCC Report 517, ISSN 0963-8091: <http://jncc.defra.gov.uk/page-7201>.

Planning Inspectorate (2017a). Advice Note Three: EIA consultation and notification

Planning Inspectorate (2017b). Advice Note Seven: Environmental Impact Assessment, Preliminary Environmental Information, Screening and Scoping

Planning Inspectorate (2017c). Advice Note Nine: Using the Rochdale Envelope

Planning Inspectorate (2017d). Advice Note Nine Habitats Regulations Assessment

Planning Inspectorate (2018a). Advice Note Twelve: Transboundary Impacts

Planning Inspectorate (2018b) Advice Note Seventeen: Cumulative effects assessment relevant to nationally significant infrastructure projects. (Online) Available from: <https://infrastructure.planninginspectorate.gov.uk/wp-content/uploads/2015/12/Advice-note-17V4.pdf>

Planning Inspectorate (2016a). Advice Note Ten: Habitats Regulations Assessment

Planning Inspectorate (2017) Advice Note 18: The Water Framework Directive. (Online) Available from: [https://infrastructure.planninginspectorate.gov.uk/wp-content/uploads/2017/06/advice\\_note\\_18.pdf](https://infrastructure.planninginspectorate.gov.uk/wp-content/uploads/2017/06/advice_note_18.pdf) (Accessed: 19/07/2019)

RenewableUK (2017) Report on Offshore Wind UK Content (Online) Available from: [https://cdn.ymaws.com/www.renewableuk.com/resource/resmgr/publications/Offshore\\_Wind\\_Investment\\_V4.pdf](https://cdn.ymaws.com/www.renewableuk.com/resource/resmgr/publications/Offshore_Wind_Investment_V4.pdf) (Accessed: 19/07/2019)

Royal HaskoningDHV UK Ltd., (2009) Dudgeon Offshore Wind Farm Environmental Statement and associated technical supporting documents

Royal HaskoningDHV UK Ltd., (2009) Sheringham Shoal Offshore Wind Farm Environmental Statement and associated technical supporting documents

Royal Yachting Association (RYA) (2019). The RYA's Position on Offshore Renewable Energy Developments: Paper 1 (of 4) – Wind Energy, June 2019. Available at: <https://www.rya.org.uk/SiteCollectionDocuments/legal/Web%20Documents/Environment/RYA%20Position%20OREI%20Wind%20Energy.pdf>. [Accessed 17/09/2019]

Russell, D.J.F (2016). Movements of grey seal that haul out on the UK coast of the southern North Sea. Report for the Department of Energy and Climate Change (OESEA-14-47).

Russell, D.J.F, Jones, E.L. and Morris, C.D. (2017). Updated Seal Usage Maps: The Estimated at-sea Distribution of Grey and Harbour Seals. *Scottish Marine and Freshwater Science* Vol 8 No 25, 25pp. DOI: 10.7489/2027-1.

Russell, D.J.F. and McConnell, B.J. (2014). Seal at-sea distribution, movements and behaviour. Report to DECC. URN: 14D/085. March 2014 (final revision).

Russell, D.J.F., Brasseur, S.M.J.M., Thompson, D., Hastie, G.D., Janik, V.M., Aarts, G., McClintock, B.T., Matthiopoulos, J., Moss, S.E.W. and McConnell, B. (2014). Marine mammals trace anthropogenic structures at sea'. *Current Biology* Vol 24 No 14: R638–R639.

Russell, D.J.F., Hastie, G.D., Thompson, D., Janik, V.M., Hammond, P.S., Scott-Hayward, L.A.S., Matthiopoulos, J., Jones, E.L. and McConnell, B.J. (2016). Avoidance of wind farms by harbour seals is limited to pile driving activities. *Journal of Applied Ecology*: doi: 10.1111/1365-2664.12678.

Scheidat, M., Tougaard, J., Brasseur, S., Carstensen, J., van Polanen Petel, T., Teilmann, J., and Reijnders, P. (2011). Harbour porpoise (*Phocoena phocoena*) and wind farms: a case study in the Dutch North Sea. *Environ. Res. Lett.* 6 (April-June 2011) 025102.

Scira (2006). Sheringham Shoal Offshore Wind Farm. Second Post-Construction Benthic Monitoring Survey. Prepared for Scira Ltd by Marine Ecological Surveys Limited.

Scira Offshore Energy Ltd. (2006) Sheringham Shoal Offshore Wind Farm Environmental Statement

SCOS (2018). Scientific Advice on Matters Related to the Management of Seal Populations: 2018. Available from: <http://www.smru.st-andrews.ac.uk>.

Scottish Natural Heritage (2012) Assessing the Cumulative Impact of Onshore Wind Energy Developments.

Scottish Natural Heritage (2017) Visual Representation of Wind Farms: Version 2.2, February 2017.

Sea Watch Foundation (2019). Reports of cetacean sightings eastern England, (Online) Available from: <http://www.seawatchfoundation.org.uk/recent sightings/>

Sharples R.J., Matthiopoulos, J. and Hammond, P.S. (2008) Distribution and movements of harbour seals around the coast of Britain: Outer Hebrides, Shetland, Orkney, the Moray Firth, St Andrews Bay, The Wash and the Thames, Report to DTI July 2008.

Skov, H., Heinänen, S., Norman, T., Ward, R.M., Méndez-Roldán, R.S., Ellis, I. (2018) ORJIP Bird Collision and Avoidance Study. Final report – April 2018. The Carbon Trust.

Southall, B.L., Finneran, J.J., Reichmuth, C., Nachtigall, P.E., Ketten, D.R., Bowles, A.E., Ellison, W.T., Nowacek, D.P. and Tyack, P.L. (2019). Marine Mammal Noise Exposure Criteria: Updated Scientific Recommendations for Residual Hearing Effects. *Aquatic Mammals* 2019, 45(2), 125-232, DOI 10.1578/AM.45.2.2019.125.



Statoil (2015) Dugdeon Offshore Wind Farm Aviation Lighting Plan. Document number C177-DOW-S-TB-003 February 2015

Stern, N. (2006) The Stern Review: The Economics of Climate Change

Strachan and Moorhouse (2011) Water Vole Conservation Handbook, 3rd Edition

Surfers Against Sewage (SAS) (2009). Guidance on environmental impact assessment of offshore renewable energy development on surfing resources and recreation. Available online at: <https://www.sas.org.uk/wp-content/uploads/sas-guidance-on-environmental-impact-assessment-1.pdf>

Teilmann, J., Carstensen, J., Dietz, R., Edrén, S. and Andersen, S. (2006). Final report on aerial monitoring of seals near Nysted Offshore Wind Farm Technical report to Energi E2 A/S. Ministry of the Environment Denmark.

Thaxter, C., Lascelles, B., Sugar, K., Cook, A., Roos, S., Bolton, M., Langston, R., Burton, N. (2012) Seabird foraging ranges as a preliminary tool for identifying candidate Marine Protected Areas. *Biological Conservation* 156. <https://doi.org/10.1016/j.biocon.2011.12.009>

The Crown Estate (2019) Record of the Habitats Regulations Assessment Undertaken under Regulation 63 of The Conservation of Habitats and Species Regulations 2017 and Regulation 28 of The Conservation of Offshore Marine Habitats and Species Regulations 2017. 2017 Offshore Wind Extensions Plan. Dated 28 August 2019

Topham, G. (2012) 'Road accident statistics: how safe are our roads?' The Guardian, 2nd February. (Online) Available from: <https://www.theguardian.com/news/datablog/2012/feb/02/road-accident-statistics-cyclists> (Accessed 31/07/2019)

Tougaard, J., Carstensen, J. and Teilmann, J. (2009a). Pile driving zone of responsiveness extends beyond 20km for harbour porpoises (*Phocoena (L.)*) (L. J. *Acoust. Soc. Am.*, 126, pp. 11-14.

Tougaard, J., Carstensen, J., Wisch, M.S., Teilmann, J., Bech, N., Skov, H. and Henriksen, O.D. (2005). Harbour porpoises on Horns reef — effects of the Horns Reef Wind farm. Annual Status Report 2004 to Elsam. NERI, Roskilde (Also Available from: [www.hornsrev.dk](http://www.hornsrev.dk)).

Tougaard, J., Henriksen, O.D. and Miller, L.A. (2009b). Underwater noise from three types of offshore wind turbines: estimation of impact zones for harbour porpoise and harbour seals. *Journal of the Acoustic Society of America* 125(6): 3766.

Tudor, C. (2014) An approach to landscape character assessment. Natural England.

UK SNCBs, (2014) Joint Response from the Statutory Nature Conservation Bodies to the Marine Scotland Science Avoidance Rate Review.

UK SNCBs, (2017) Joint SNCB Interim Displacement Advice Note: Advice on how to present assessment information on the extent and potential consequences of seabird displacement from Offshore Wind Farm (OWF) developments.



Visit Norfolk (2019) (Online) Available from: [www.visitnorfolk.co.uk](http://www.visitnorfolk.co.uk) (Accessed 16/07/19)

Wakefield, E.D., Owen, E., Baer, J., Carroll, M.J., Daunt, F., Dodd, S.G., Green, J.A., Guilford, T., Mavor, R.A., Miller, P.I., Newell, M.A., Newton, S.F., Robertson, G.S., Shoji, A., Soanes, L.M., Votier, S.C., Wanless, S., Bolton, M. (2017) Breeding density, fine-scale tracking, and large-scale modeling reveal the regional distribution of four seabird species. *Ecological Applications* 27, 2074–2091. <https://doi.org/10.1002/eap.1591>

Ware, S.J & Kenny, A.J (2011) *Guidelines for the Conduct of Benthic Studies at Marine Aggregate Extraction Sites* (2nd edition). Marine Aggregate Levy Sustainability Fund 80pp.

Wessex Archaeology (2006) *Sheringham Shoal Offshore Windfarm Stage 2 Archaeological Recording and Sampling of Vibrocores*. WA Ref. 61032.02.

Wildfowl and Wetland Trust (WWT) (2009). *Distributions of Cetaceans, Seals, Turtles, Sharks and Ocean Sunfish recorded from Aerial Surveys 2001-2008: Report to Department of Energy and Climate Change*.

Wilson, B. Batty, R. S., Daunt, F. and Carter, C. (2007). *Collision risks between marine renewable energy devices and mammals, fish and diving birds*. Report to the Scottish Executive. Scottish Association for Marine Science, Oban, Scotland.

Wind Energy and Aviation Interests (2002) *Interim Guidelines*

Wischniewski, S., Fox, D.S., McCluskie, A., Wright, L.J. (2017) *Seabird tracking at the Flamborough & Filey Coast: Assessing the impacts of offshore wind turbines (Pilot study 2017 Fieldwork report & recommendations: Report to Orsted)*. RSPB Centre for Conservation Science, Sandy.

World Health Organization (2000) *Guideline for Community Noise*. Geneva, World Health Organization.

World Health Organization (2009) *Night Noise Guidelines for Europe*. Denmark, World Health Organization.

World Health Organization (2018) *Environmental Noise Guidelines for the European Region*. Denmark, World Health Organization.

Wuebbles, D.J, D.W. Fahey, K.A. Hibbard, B. DeAngelo, S. Doherty, K. Hayhoe, R. Horton, J.P. Kossin, P.C. Taylor, A.M. Waple, and C.P. Weaver, (2017) *Climate Science Special Report: Fourth National Climate Assessment, Volume I*. U.S. Global Change Research Program, Washington D.C., USA, pp. 12-34

## APPENDIX 1 NPS ASSESSMENT REQUIREMENTS

1. NPS EN-1 and EN-3 assessment requirements relevant to EIA topics are summarised below.

*Table A1-1 Marine Geology, Oceanography and Physical Processes*

NPS Requirement	NPS reference
‘where relevant, applicants should undertake coastal geomorphological and sediment transfer modelling to predict and understand impacts and help identify relevant mitigating or compensatory measures’	EN-1 – 5.5.6
<p>‘the ES should include an assessment of the effects on the coast. In particular, applicants should assess:</p> <ul style="list-style-type: none"> <li>the impact of the proposed project on coastal processes and geomorphology, including by taking account of potential impacts from climate change. If the development will have an impact on coastal processes the applicant must demonstrate how the impacts will be managed to minimise adverse impacts on other parts of the coast.</li> <li>the vulnerability of the proposed development to coastal change, taking account of climate change, during the project’s operational life and any decommissioning period.’</li> </ul>	EN-1 – 5.5.7
‘the applicant should be particularly careful to identify any effects of physical changes on the integrity and special features of Marine Conservation Zones, candidate marine Special Areas of Conservation (SACs), coastal SACs and candidate coastal SACs, coastal Special Protection Areas (SPAs) and potential SCIs and Sites of Special Scientific Interest (SSSI).’	EN-1 – 5.5.9
<p>‘an assessment of the effects of installing cable across the intertidal zone should include information, where relevant, about:</p> <ul style="list-style-type: none"> <li>increased suspended sediment loads in the intertidal zone during installation.’</li> </ul>	EN-3 – 2.6.81
<p>‘where necessary, assessment of the effects on the subtidal environment should include:</p> <ul style="list-style-type: none"> <li>loss of habitat due to foundation type including associated seabed preparation, predicted scour, scour protection and altered sedimentary processes.</li> <li>environmental appraisal of inter-array and cable routes and installation methods.</li> <li>increased suspended sediment loads during construction.’</li> </ul>	EN-3 – 2.6.113
‘the assessment should include predictions of the physical effect that will result from the construction and operation of the required infrastructure and include effects such as the scouring that may result from the proposed development.’	EN-3 – 2.6.194

*Table A1-2 Marine Water and Sediment Quality*

NPS Requirement	NPS reference
Adverse effects on the water environment, including transitional waters and coastal waters, from discharges and increased risk of spills and leaks of pollutants. Could result in surface and ground waters of protected areas failing to meet environmental objectives established under the Water Framework Directive [WFD].	EN1 - 5.15.1
The application should undertake an assessment of the existing status of, and impacts of the proposed project, on water quality, water resources and physical characteristics of the water environment.	EN-1 – 5.15.2
Marine water quality affected through the disturbance of sea bed sediments or the release of contaminants with subsequent indirect effects on habitats, biodiversity and fish stocks.	EN-3 – 2.6.189
The Environment Agency regulates emissions to land, air and water out to 3 nautical miles (nm). Where development is located within 3nm of the coast, the Environment Agency should be consulted at the pre-application stage.	EN-3 – 2.6.191
Beyond 3nm, the Marine Management Organisation (MMO) is the regulator. The applicant should consult the MMO and Centre for Environment, Fisheries and Aquaculture Science (Cefas) at the pre-application stage.	EN-3 – 2.6.192

*Table A1-3 Benthic and Intertidal Ecology*

NPS Requirement	NPS reference
Clearly set out any effects on internationally, nationally and locally designated sites of ecological or geological conservation importance, on protected species and on habitats and other species identified as being of principal importance for the conservation of biodiversity.	EN-1 - 5.3.3
The ES should include an assessment of the effects on the coast. In particular, applicants should assess...the effects of the proposed project on marine ecology, biodiversity and protected sites	EN-1 – 5.5.7
Assessment of offshore ecology and biodiversity should be undertaken by the applicant for all stages of the lifespan of the proposed offshore wind farm and in accordance with the appropriate policy for offshore wind farm EIAs.	EN-3 – 2.6.64
Any relevant data that has been collected as part of post-construction ecological monitoring from existing, operational offshore wind farm should be referred to where appropriate.	EN-3 – 2.6.66
The assessment should include the potential for the scheme to have both positive and negative impacts on marine ecology and biodiversity.	EN-3 – 2.6.67

NPS Requirement	NPS reference
<p>An assessment of the effects of installing cable across the intertidal zone should include information, where relevant, about:</p> <ol style="list-style-type: none"> <li>1. Any alternative landfall sites that have been considered by the applicant during the design phase and an explanation for the final choice;</li> <li>2. Any alternative cable installation methods that have been considered by the applicant during the design phase and an explanation for the final choice;</li> <li>3. Potential loss of habitat;</li> <li>4. Disturbance during cable installation and removal (decommissioning);</li> <li>5. Increased suspended sediment loads in the intertidal zone during installation; and</li> <li>6. Predicted rates at which the intertidal zone might recover from temporary effects.</li> </ol>	<p>EN-3 – 2.6.81</p>
<p>Where necessary, assessment of the effects on the subtidal environment should include:</p> <ol style="list-style-type: none"> <li>7. Loss of habitat due to foundation type including associated sea bed preparation, predicted scour, scour protection and altered sedimentary processes;</li> <li>8. Environmental appraisal of array cables and cable routes and installation methods;</li> <li>9. Habitat disturbance from construction vessels' extendible legs and anchors;</li> <li>10. Increased suspended sediment loads during construction; and</li> <li>11. Predicted rates at which the subtidal zone might recover from temporary effects.</li> </ol>	<p>EN-3 – 2.6.113</p>
<p>Construction and decommissioning methods should be designed appropriately to minimise effects on subtidal habitats, taking into account other constraints. Mitigation measures which the Infrastructure Planning Commission (IPC) (now the Planning Inspectorate) should expect the applicants to have considered may include:</p> <ul style="list-style-type: none"> <li>• surveying and micrositing of the export cable route to avoid; adverse effects on sensitive habitat and biogenic reefs;</li> <li>• burying cables at a sufficient depth, taking into account other constraints, to allow the seabed to recover to its natural state; and</li> <li>• the use of anti-fouling paint might be minimised on subtidal surfaces, to encourage species colonisation on the structures.</li> </ul>	<p>EN-3 – 2.6.119</p>
<p>Where cumulative effects on subtidal habitats are predicted as a result of the cumulative effects of multiple cable routes, it may be appropriate for applicants for various schemes to work together to ensure that the number of cables crossing the subtidal zone is minimised and installation/decommissioning phases are coordinated to ensure that disturbance is reasonably minimised.</p>	<p>EN-3 – 2.6.120</p>

*Table A1-4 Fish and Shellfish Ecology*

NPS Requirement	NPS reference
Clearly set out any effects on internationally, nationally and locally designated sites of ecological or geological conservation importance, on protected species and on habitats and other species identified as being of principal importance for the conservation of biodiversity.	EN-1 - 5.3.3
There is the potential for the construction and decommissioning phases...to interact with seabed sediments and therefore have the potential to impact fish communities, migration routes, spawning activities and nursery areas of particular species. In addition, there are potential noise impacts, which could affect fish during construction and decommissioning and to a lesser extent during operation.	EN-3 – 2.6.73
<p>The applicant should identify fish species that are the most likely receptors of impacts with respect to:</p> <ul style="list-style-type: none"> <li>• spawning grounds;</li> <li>• nursery grounds;</li> <li>• feeding grounds;</li> <li>• over-wintering areas for crustaceans; and</li> <li>• migration routes.</li> </ul>	EN-3 – 2.6.74
EMF during operation may be mitigated by use of armoured cable for inter-array and export cables that should be buried at a sufficient depth. Some research has shown that where cables are buried at depths greater than 1.5m below the seabed impacts are likely to be negligible. However, sufficient depth to mitigate impacts will depend on the geology of the seabed.	EN-3 – 2.6.76
During construction, 24 hour working practices may be employed so that the overall construction programme and the potential for impacts to fish communities is reduced in overall time.	EN-3 – 2.6.77

*Table A1-5 Marine Mammal Ecology*

NPS Requirement	NPS reference
Clearly set out any effects on internationally, nationally and locally designated sites of ecological or geological conservation importance, on protected species and on habitats and other species identified as being of principal importance for the conservation of biodiversity.	EN-1 – 5.3.3
Assessment of offshore ecology and biodiversity should be undertaken by the applicant for all stages of the lifespan of the proposed offshore wind farm and in accordance with the appropriate policy for offshore wind farm EIAs.	EN-3 – 2.6.64
Any relevant data that has been collected as part of post-construction ecological monitoring from existing, operational offshore wind farm should be referred to where appropriate.	EN-3 – 2.6.66

NPS Requirement	NPS reference
The assessment should include the potential for the scheme to have both positive and negative impacts on marine ecology and biodiversity.	EN-3 – 2.6.67
There are specific considerations from piling noise which apply to offshore wind energy infrastructure proposals with regard to marine mammals, including cetaceans and seals, which have statutory protection. Offshore piling may reach noise levels which are high enough to cause injury, or even death, to marine mammals. If piling associated with an offshore wind farm is likely to lead to the commission of an offence (which would include deliberately disturbing, killing or capturing a European Protected Species), an application may have to be made for a wildlife licence to allow the activity to take place.	EN-3 – 2.6.90 and 2.6.91
<p>Where necessary, assessment of the effects on marine mammals should include details of:</p> <ul style="list-style-type: none"> <li>• likely feeding areas;</li> <li>• known birthing areas/haul out sites;</li> <li>• nursery grounds;</li> <li>• known migration or commuting routes;</li> <li>• duration of the potentially disturbing activity including cumulative / in-combination effects with other plans or projects;</li> <li>• baseline noise levels;</li> <li>• predicted noise levels in relation to mortality, permanent threshold shift (PTS) and temporary threshold shift (TTS);</li> <li>• soft-start noise levels according to proposed hammer and pile design; and</li> <li>• operational noise.</li> </ul>	EN-3 – 2.6.92

Table A1-6 Offshore Ornithology

NPS Requirement	NPS reference
Clearly set out any effects on internationally, nationally and locally designated sites of ecological conservation importance, on protected species and on habitats and other species identified as being of principal importance for the conservation of biodiversity.	EN-1 – 5.3.3
Assessment of offshore ecology and biodiversity should be undertaken by the applicant for all stages of the lifespan of the proposed offshore wind farm and in accordance with the appropriate policy for offshore wind farm EIAs.	EN-3 – 2.6.64
Any relevant data that has been collected as part of post-construction ecological monitoring from existing, operational offshore wind farm should be referred to where appropriate.	EN-3 – 2.6.66
The assessment should include the potential of the scheme to have both positive and negative effects on marine ecology and biodiversity.	EN-3 – 2.6.67



NPS Requirement	NPS reference
The scope, effort and methods required for ornithological surveys should have been discussed with the relevant statutory advisor.	EN-3 – 2.6.102
Relevant data from operational offshore wind farms should be referred to in the applicant’s assessment.	EN-3 – 2.6.103
It may be appropriate for assessment to consider collision risk modelling for certain species of birds.	EN-3 – 2.6.104

*Table A1-7 Commercial Fisheries*

NPS Requirement	NPS reference
Where the project is likely to have socio-economic impacts at local or regional levels, the applicant should undertake and include in their application an assessment of these impacts as part of the ES.	EN-1 – 5.12.2
The construction and operation of offshore windfarms can have both positive and negative effects on fish and shellfish stocks.	EN-3 – 2.6.122
The offshore windfarm and any associated infrastructure may be a hindrance to certain types of commercial fishing activity such as trawling and longlining, but other fishing activities may be able to take place within operational windfarms without unduly disrupting or compromising navigational safety. Consequently, the establishment of a windfarm can increase the potential for some fishing activities, such as potting.	EN-3 – 2.6.123
In some circumstances, transboundary issues may be a consideration as fishermen from other countries may fish in waters within which offshore windfarms are sited.	EN-3 – 2.6.124
Early consultation should be undertaken with statutory advisors and with representatives of the fishing industry which could include discussion of impact assessment methodologies. Where any part of the proposal involves a grid connection to shore, appropriate inshore fisheries groups should be consulted.	EN-3 – 2.6.127
Where a number of offshore windfarms have been proposed within an identified zone, it may be beneficial to undertake such consultation at a zonal, rather than a site specific, level.	EN-3 – 2.6.128
The assessment by the applicant should include surveys of the effects on fish stocks of commercial interest and any potential reduction in such stocks, as well as any likely constraints on fishing activity within the project boundaries. Robust baseline data should have been collected and studies conducted as part of the assessment.	EN-3 – 2.6.129

NPS Requirement	NPS reference
Where there is a possibility that safety zones will be sought around offshore infrastructure, potential effects should be included in the assessment on commercial fishing.	EN-3 – 2.6.130
Where the precise extents of potential safety zones are unknown, a realistic worst case scenario should be assessed. Applicants should consult the MCA. Exclusion of certain types of fishing may make an area more productive for other types of fishing. The assessment by the applicant should include surveys of the effects on fish stocks of commercial interest and the potential reduction or increase in such stocks that will result from the presence of the windfarm development and of any safety zones.	EN-3 – 2.6.131

*Table A1-8 Shipping and Navigation*

NPS Requirement	NPS reference
Applicants should establish stakeholder engagement with interested parties in the navigation sector early in the development phase of the proposed offshore wind farm and this should continue throughout the life of the development including during the construction, operation and decommissioning phases. Such engagement should be taken to ensure that solutions are sought that allow offshore wind farms and navigation uses of the sea to successfully co-exist.	EN-3 – 2.6.153
Assessment should be underpinned by consultation with the MMO, Maritime and Coastguard Agency (MCA), the relevant General Lighthouse Authority, the relevant industry bodies (both national and local) and any representatives of recreational users of the sea, such as the Royal Yachting Association (RYA), who may be affected.	EN-3 – 2.6.154
Information on internationally recognised sea lanes is publicly available and this should be considered by applicants prior to undertaking assessments. The assessment should include reference to any relevant, publicly available data available on the Maritime Database.	EN-3 – 2.6.155
Applicants should undertake a Navigational Risk Assessment (NRA) in accordance with relevant Government guidance prepared in consultation with the MCA and the other navigation stakeholders listed above.	EN-3 – 2.6.156
Where there is a possibility that safety zones will be sought around offshore infrastructure, potential effects should be included in the assessment on navigation and shipping.	EN-3 – 2.6.158
Where the precise extents of potential safety zones are unknown, a realistic worst-case scenario should be assessed. Applicants should consult the MCA and refer to the Government guidance on safety zones.	EN-3 – 2.6.159
The potential effect on recreational craft, such as yachts, should be considered in any assessment.	EN-3 – 2.6.160

*Table A1-9 Offshore Archaeology and Cultural Heritage (historic environment)*

NPS Requirement	NPS reference
As part of the ES the applicant should provide a description of the significance of the heritage assets affected by the proposed development and the contribution of their setting to that significance. The level of detail should be proportionate to the importance of the heritage assets and no more than is sufficient to understand the potential impact of the proposal on the significance of the heritage asset.	EN-1 – 5.8.8
Where a development site includes, or the available evidence suggests it has the potential to include, heritage assets with an archaeological interest, the applicant should carry out appropriate desk-based assessment and, where such desk-based research is insufficient to properly assess the interest, a field evaluation.	EN-1 – 5.8.9
Where proposed development will affect the setting of a heritage asset, representative visualisations may be necessary to explain the impact.	EN-1 – 5.8.9
The applicant should ensure that the extent of the impact of the proposed development on the significance of any heritage assets affected can be adequately understood from the application and supporting documents.	EN-1 – 5.8.10
Consultation with the relevant statutory consultees (including English Heritage) should be undertaken by the applicants at an early stage of the development.	EN-3 – 2.6.140
Assessment should be undertaken as set out in Section 5.8 of EN-1. Desk based studies should take into account any geotechnical or geophysical surveys that have been undertaken to aid the wind farm design,	EN-3 – 2.6.141
Assessment should also include the identification of any beneficial effects on the historic marine environment, for example through improved access or the contribution to new knowledge that arises from investigation.	EN-3 – 2.6.142
Where elements of an application (whether offshore or onshore) interact with features of historic maritime significance that are located onshore, the effects should be assessed in accordance with the policy at Section 5.8 in EN-1.	EN-3 – 2.6.143

*Table A1-10 Aviation and MoD*

NPS Requirement	NPS reference
Where the proposed development may have an effect on civil or military aviation and/or other defence assets an assessment of potential effects should be set out in the ES.	EN-1 – 5.4.10

NPS Requirement	NPS reference
<p>The applicant should consult the MoD, CAA, NATS and any aerodrome – licenses or otherwise- likely to be affected by the proposed development in preparing an assessment of the proposal on aviation or other defence interests.</p>	<p>EN-1 – 5.4.11</p>
<p>Any assessment of aviation or other defence interests should include potential impacts on the project upon the operation of CNS infrastructure, flight patterns (both civil and military), other defence assets and aerodrome operational procedures. It should also assess the cumulative effects of the project with other relevant projects in relation to aviation and defence.</p>	<p>EN-1 – 5.4.12</p>
<p>If any relevant changes are made to proposals during the pre-application and determination period, it is the responsibility of the applicant to ensure that the relevant aviation and defence consultees are informed as soon as reasonably possible.</p>	<p>EN-1 – 5.4.13</p>
<p>The effects on civil and military aerodromes, aviation technical sites and other defence assets have been addressed by the applicant and that any necessary assessment of the proposal on aviation or defence interests has been carried out. In particular, it should be satisfied that the proposal has been designed to minimise adverse impacts on the operation and safety of aerodromes and that reasonable mitigation is carried out.</p>	<p>EN-1 – 5.4.14</p>
<p>If there are conflicts between the Government’s energy and transport policies and military interests in relation to the application, the decision maker should expect the relevant parties to have made appropriate efforts to work together to identify realistic and pragmatic solutions to the conflicts. In so doing, the parties should seek to protect the aims and interests of the other parties as far as possible.</p>	<p>EN-1 – 5.4.15</p>
<p>There are statutory requirements concerning lighting to tall structures where lighting is requested on structures that go beyond statutory requirements by any of the relevant aviation and defence consultees, the decision maker should satisfy itself of the necessity of such lighting taking into account the case put forward by the consultees. The effect of such lighting on the landscape and ecology may be a relevant consideration.</p>	<p>EN-1 – 5.4.16</p>
<p>Where after reasonable mitigation, operational changes, obligations and requirements have been proposed, the decision maker considers that:</p> <ul style="list-style-type: none"> <li>• A development would prevent a licensed aerodrome from maintaining its licence;</li> <li>• The benefits of the proposed development are outweighed by the harm to aerodromes serving business, training or emergency service needs, taking into account the relevant importance and needs for such aviation infrastructure;</li> </ul>	<p>EN-1 – 5.4.17</p>

NPS Requirement	NPS reference
<ul style="list-style-type: none"> <li>• The development would significantly impede or compromise the safe and effective use of defence assets or significantly limit military training; or</li> <li>• The development would have an impact on the safe and efficient provision of en route air traffic control services for civil aviation, in particular through an adverse effect on the infrastructure required to support communications, navigation or surveillance systems; consent should not be granted.</li> </ul>	
<p>Where a potential offshore wind farm is proposed close to existing operational offshore infrastructure, or has the potential to affect activities for which a licence has been issued by Government, the applicant should undertake an assessment of the potential effect of the proposed development on such existing or permitted infrastructure or activities. The assessment should be undertaken for all stages of the lifespan of the proposed wind farm in accordance with the appropriate policy for offshore wind farm EIAs.</p>	<p>EN-3 – 2.6.179</p>
<p>Applicants should engage with interested parties in the potentially affected offshore sectors early in the development phase of the proposed offshore wind farm, with an aim to resolve as many issues as possible prior to the submission of an application to the IPC.</p>	<p>EN-3 – 2.6.180</p>
<p>Such stakeholder engagement should continue throughout the life of the development including construction, operation and decommissioning phases where necessary. As many of these offshore industries are regulated by Government, the relevant Secretary of State should also be a consultee where necessary. Such engagement should be taken to ensure that solutions are sought that allow offshore wind farms and other uses of the sea to successfully co-exist.</p>	<p>EN-3 – 2.6.181</p>

*Table A1-11 Offshore Designated Sites*

NPS Requirement	NPS reference
<p>Where the development is subject to EIA the applicant should ensure that the ES clearly sets out any effects on internationally, nationally and locally designated sites of ecological or geological conservation importance, on protected species and on habitats and other species identified as being of principal importance for the conservation of biodiversity. The applicant should provide environmental information proportionate to the infrastructure where EIA is not required to help the IPC consider thoroughly the potential effects of a proposed project.</p>	<p>EN-1 – 5.3.3</p>
<p>The ES (see <b>Section 4.2</b>) should include an assessment of the effects on the coast. In particular, applicants should assess:</p> <ul style="list-style-type: none"> <li>• the effects of the proposed project on marine ecology, biodiversity and protected sites;</li> </ul>	<p>EN-1 – 5.5.7</p>

NPS Requirement	NPS reference
<p>The applicant should be particularly careful to identify any effects of physical changes on the integrity and special features of Marine Conservation Zones, candidate marine Special Areas of Conservation (SACs), coastal SACs and candidate coastal SACs, coastal Special Protection Areas (SPAs) and potential coastal SPAs, Ramsar sites, Sites of Community Importance (SCIs) and potential SCIs and Sites of Special Scientific Interest.</p>	<p>EN-1 – 5.5.9</p>
<p>Factors that will determine the likely noise impact include:</p> <ul style="list-style-type: none"> <li>the proximity of the proposed development to designated sites where noise may have an adverse impact on protected species or other wildlife</li> </ul>	<p>EN-1 – 5.11.3</p>
<p>Infrastructure development can have adverse effects on the water environment, including transitional waters and coastal waters. During the construction, operation and decommissioning phases, discharges would occur. There may also be an increased risk of spills and leaks of pollutants to the water environment. These effects could lead to adverse impacts on health or on protected species and habitats and could, in particular, result in surface waters, ground waters of protected areas failing to meet environmental objectives established under the Water Framework Directive [WFD].</p>	<p>EN-1 - 5.15.1</p>
<p>In sites with nationally recognised designations (Sites of Special Scientific Interest, National Nature Reserves, National Parks, the Broads, Areas of Outstanding Natural Beauty and Registered Parks and Gardens), consent for renewable energy projects should only be granted where it can be demonstrated that the objectives of designation of the area will not be compromised by the development, and any significant adverse effects on the qualities for which the area has been designated are clearly outweighed by the environmental, social and economic benefits.</p>	<p>EN-3 – 2.5.33</p>

*Table A1-12 Offshore Air Quality*

NPS Requirement	NPS reference
<p>Where the project is likely to have adverse effects on air quality the applicant should undertake an assessment of the impacts of the proposed project as part of the Environmental Statement (ES).</p>	<p>EN-1 5.2.6</p>
<p>The ES should describe:</p> <ul style="list-style-type: none"> <li>any significant air emissions, their mitigation and any residual effects distinguishing between the project stages and taking account of any significant emissions from any road traffic generated by the project;</li> <li>the predicted absolute emission levels of the proposed project, after mitigation methods have been applied;</li> <li>existing air quality levels and the relative change in air quality from existing levels; and</li> <li>any potential eutrophication impacts</li> </ul>	<p>EN-1 5.2.7</p>



*Table A1-13 Other Marine Users*

NPS Requirement	NPS reference
Where a potential offshore wind farm is proposed close to existing operational offshore infrastructure, or has the potential to affect activities for which a licence has been issued by Government, the applicant should undertake an assessment of the potential effect of the proposed development on such existing or permitted infrastructure or activities for all stages of the lifespan of the proposed wind farm.	EN-3 – 2.6.179
Applicants should engage with interested parties in the potentially affected offshore sectors early in the development phase of the proposed offshore wind farm, with an aim to resolve as many issues as possible prior to the submission of an application.	EN-3 – 2.6.180
Such stakeholder engagement should continue throughout the life of the development including construction, operation and decommissioning phases where necessary. As many of these offshore industries are regulated by Government, the relevant Secretary of State should also be a consultee where necessary. Such engagement should be taken to ensure that solutions are sought that allow offshore wind farms and other uses of the sea to successfully co-exist.	EN-3 – 2.6.181

*Table A1-14 Ground Conditions and Contamination*

NPS Requirement	NPS reference
‘Clearly set out any effects on internationally, nationally and locally designated sites of ecological or geological conservation importance, on protected species and on habitats and other species identified as being of principal importance for the conservation of biodiversity.’	EN-1 – 5.3.3
‘The applicant should show how the project has taken advantage of opportunities to conserve and enhance biodiversity and geological conservation interests’.	EN-1 – 5.3.4
‘The development should aim to avoid significant harm to biodiversity and geological conservation interests, including through mitigation and consideration of reasonable alternatives; where significant harm cannot be avoided, then appropriate compensation measures should be sought’.	EN-1- 5.3.7
‘For developments on previously developed land, Applicants should ensure that they have considered the risk posed by land contamination.’	EN-1 Section 5.10.8.
‘Applicants should safeguard any mineral resources on the proposed site as far as possible, taking into account the long-term potential of the land use after any future decommissioning has taken place’.	EN-1- 5.10.9
‘The applicant should include an assessment of the impact of the waste arising from development on the capacity of waste management	EN-1- 5.14.6

NPS Requirement	NPS reference
facilities to deal with other waste arising in the area for at least five years of operation.	

*Table A1-15 Water Resources and Flood Risk (freshwater quality and resource)*

NPS Requirement	NPS reference
‘Applications for energy projects of 1 hectare or greater in Flood Zone 1 in England or Zone A in Wales and all proposals for energy projects located in Flood Zones 2 and 3 in England or Zones B and C in Wales should be accompanied by a flood risk assessment (FRA).’	EN-1 – 5.7
<p>‘Where the project is likely to have effects on the water environment, the applicant should undertake an assessment of the existing status of, and impacts of the proposed project on, water quality, water resources and physical characteristics of the water environment as part of the ES or equivalent.</p> <p>The ES should in particular describe:</p> <ul style="list-style-type: none"> <li>• The existing quality of waters affected by the proposed project and the impacts of the proposed project on water quality, noting any relevant existing discharges, proposed new discharges and proposed changes to discharges;</li> <li>• Existing water resources affected by the proposed project and the impacts of the proposed project on water resources;</li> <li>• Existing physical characteristics of the water environment (including quantity and dynamics of flow) affected by the proposed project and any impact of physical modifications to these characteristics; and</li> <li>• Any impacts of the proposed project on water bodies or protected areas under the Water Framework Directive and source protection zones (SPZs) around potable groundwater abstractions.’</li> </ul>	EN-1 – 5.15

*Table A1-16 Land Use and Agriculture*

NPS Requirement	NPS reference
The ES should identify existing and proposed land uses near the project, any effects of replacing an existing development or use of the site with the proposed project or preventing a development or use on a neighbouring site from continuing. Applicants should also assess any effects of precluding a new development or use proposed in the development plan.	EN-1 Section 5.10.5.
Applicants should seek to minimise impacts on the best and most versatile agricultural land (defined as land in grades 1, 2 and 3 of the Agricultural Land Classification) and preferably use land in areas of poorer quality (grades 4 and 5) except where this would be inconsistent with other sustainability considerations. Applicants should also identify	EN-1 Section 5.10.8.

NPS Requirement	NPS reference
any effects and seek to minimise impacts on soil quality taking into account any mitigation measures proposed.	
Applicants should determine whether their proposal, or any part of it, is within an established Green Belt and if it is, whether their proposal may be inappropriate development within the meaning of Green Belt policy.	EN-1 Section 5.10.10.

*Table A1-17 Onshore Ecology and Ornithology*

NPS Requirement	NPS reference
The applicant should ensure that the ES clearly sets out any effects on internationally, nationally and locally designated sites of ecological or geological conservation importance, on protected species and on habitats and other species identified as being of principal importance for the conservation of biodiversity.	EN-1 – 5.3.3
The applicant should show how the project has taken advantage of opportunities to conserve and enhance biodiversity and geological conservation interests.	EN-1 – 5.3.4
'Many SSSIs are also designated as sites of international importance and will be protected accordingly. Those that are not, or those features of SSSIs not covered by an international designation, should be given a high degree of protection.'	EN-1 – 5.3.10
<p>The applicant should include appropriate mitigation measures as an integral part of the proposed development and demonstrate that:</p> <ul style="list-style-type: none"> <li>• During construction, they will seek to ensure that activities will be confined to the minimum areas required for the works;</li> <li>• During construction and operation best practice will be followed to ensure that risk of disturbance or damage to species or habitats is minimised, including as a consequence of transport access arrangements;</li> <li>• Habitats will, where practicable, be restored after construction works have finished; and</li> <li>• Opportunities will be taken to enhance existing habitats and, where practicable, to create new habitats of value within the site landscaping proposals.</li> </ul>	EN-1 – 5.3.18

*Table A1-18 Onshore Archaeology and Cultural Heritage (historic environment)*

NPS Requirement	NPS reference
As part of the ES the applicant should provide a description of the significance of the heritage assets affected by the proposed development and the contribution of their setting to that significance.	EN-1 – 5.8.8
Where a development site includes, or the available evidence suggests it has the potential to include, heritage assets with an archaeological	EN-1 – 5.8.9

NPS Requirement	NPS reference
interest, the applicant should carry out appropriate desk-based assessment and, where such desk-based research is insufficient to properly assess the interest, a field evaluation.	
Where proposed development will affect the setting of a heritage asset, representative visualisations may be necessary to explain the impact.	EN-1 – 5.8.9
The applicant should ensure that the extent of the impact of the proposed development on the significance of any heritage assets affected can be adequately understood from the application and supporting documents.	EN-1 – 5.8.10
There should be a presumption in favour of the conservation of designated heritage assets and the more significant the designated heritage asset, the greater the presumption in favour of its conservation should be. Substantial harm to or loss of a grade II listed building, park or garden should be exceptional. Substantial harm to or loss of designated assets of the highest significance, including Scheduled Monuments; registered battlefields; grade I and II* listed buildings; grade I and II* registered parks and gardens; and World Heritage Sites, should be wholly exceptional.	EN-1 – 5.8.14

Table A1-19 Air Quality

NPS Requirement	NPS reference
Where the project is likely to have adverse effects on air quality the applicant should undertake an assessment of the impacts of the proposed project as part of the Environmental Statement (ES).	EN-1 5.2.6
<p>The ES should describe:</p> <ul style="list-style-type: none"> <li>any significant air emissions, their mitigation and any residual effects distinguishing between the project stages and taking account of any significant emissions from any road traffic generated by the project;</li> <li>the predicted absolute emission levels of the proposed project, after mitigation methods have been applied;</li> <li>existing air quality levels and the relative change in air quality from existing levels; and any potential eutrophication impacts</li> </ul>	EN-1 5.2.7

Table A1-20 Noise and Vibration

NPS Requirement	NPS reference
<p>Where noise impacts are likely to arise, the applicant should include:</p> <ul style="list-style-type: none"> <li>A description of the noise generating aspects of the development proposal leading to noise impacts including the identification of any distinctive tonal, impulsive or low frequency characteristics of the noise;</li> <li>Identification of noise sensitive premises and noise sensitive areas that may be affected;</li> <li>The characteristics of the existing noise environment;</li> </ul>	EN-1 – 5.11.4

NPS Requirement	NPS reference
<ul style="list-style-type: none"> <li>• A prediction of how the noise environment will change with the proposed development;</li> <li>• In the shorter term such as during the construction period;</li> <li>• In the longer term during the operating life of the infrastructure;</li> <li>• At particular times of the day, evening and night as appropriate;</li> <li>• An assessment of the effect of predicted changes in the noise environment on any noise sensitive premises and noise sensitive areas; and</li> <li>• Measures to be employed in mitigating noise.</li> <li>• The nature and extent of the noise assessment should be proportionate to the likely noise impact.</li> </ul>	
<p>The noise impact of ancillary activities associated with the development, such as increased road and rail traffic movements, or other forms of transportation, should also be considered.</p>	<p>EN-1 – 5.11.5</p>
<p>Operational noise, with respect to human receptors, should be assessed using the principles of the relevant British Standards and other guidance.</p>	<p>EN-1 – 5.11.6</p>

*Table A1-21 Traffic and Transport*

NPS Requirement	NPS reference
<p>If a project is likely to have significant transport implications, the applicant's ES should include a transport assessment, using the NATA/WebTAG methodology stipulated in Department for Transport guidance, or any successor to such methodology. Applicants should consult the Highways Agency and Highways Authorities as appropriate on the assessment and mitigation.</p>	<p>EN-1 5.13.3</p>
<p>Where appropriate, the applicant should prepare a travel plan including demand management measures to mitigate transport impacts. The applicant should also provide details of proposed measures to improve access by public transport, walking and cycling, to reduce the need for parking associated with the proposal and to mitigate transport impacts.</p>	<p>EN-1 5.13.4</p>
<p>The applicant should have assessed the various potential routes to the site for delivery of materials and components where the source of the materials is known at the time of the application and selected the route that is the most appropriate. It is possible that the exact location of the source of construction materials, such as crushed stone or concrete will not be known at the time of the application to the IPC. In these circumstances, the impact of additional vehicles on the likely potential routes should have been assessed.</p>	<p>EN-3 2.7.75</p>
<p>The applicant should assess whether the access roads are suitable for the transportation of components which will include whether they are sufficiently wide, or bridges sufficiently strong for the heavier components to be transported to the site. Any sections of the route which will require modification to allow for the transportation of components to site should be identified and potential effects assessed as part of the ES.</p>	<p>EN-3 2.7.76</p>

NPS Requirement	NPS reference
<p>There may be a number of wind farms proposed that use a common port and/or access route and pass through the same towns. Where a cumulative impact is likely then a cumulative transport assessment should form part of the EIA to consider the impacts of abnormal traffic movements relating to the project in question in-combination with those from any other relevant development. Consultation with the relevant local highways authorities is likely to be necessary</p>	<p>EN-3 2.7.77</p>

*Table A1-22 Seascape, Landscape and Visual*

NPS Requirement	NPS reference
<p>The landscape and visual assessment should include reference to any landscape character assessment and associated studies as a means of assessing landscape impacts relevant to the proposed project.</p>	<p>EN-1 – 5.9.5</p>
<p>The applicant’s assessment should include the effects during construction of the project and the effects of the completed development and its operation on landscape components and landscape character.</p>	<p>EN-1 – 5.9.6</p>
<p>The assessment should include the visibility and conspicuousness of the project during construction and of the presence and operation of the project and potential impacts on views and visual amenity. This should include light pollution effects, including on local amenity, and nature conservation.</p>	<p>EN-1 – 5.9.7</p>
<p>Where a proposed offshore wind farm will be visible from the shore, an SVIA should be undertaken which is proportionate to the scale of the potential impacts.</p>	<p>EN-3 – 2.6.202</p>
<p>Where necessary, assessment of the seascape should include an assessment of three principal considerations on the likely effect of offshore wind farms on the coast:</p> <ul style="list-style-type: none"> <li>• limit of visual perception from the coast;</li> <li>• individual characteristics of the coast which affect its capacity to absorb a development; and</li> <li>• how people perceive and interact with the seascape.</li> </ul>	<p>EN-3 – 2.6.203</p>
<p>As part of the SVIA, photomontages are likely to be required. Viewpoints to be used for the SVIA should be selected in consultation with the statutory consultees at the EIA Scoping stage.</p>	<p>EN-3 – 2.6.204</p>
<p>Magnitude of change to both the identified seascape receptors (such as seascape units and designated landscapes) and visual receptors (such as viewpoints) should be assessed in accordance with the standard methodology for SVIA.</p>	<p>EN-3 – 2.6.205</p>
<p>Where appropriate, cumulative SVIA should be undertaken in accordance with the policy on cumulative assessment outlined in Section 4.2 of EN-1.</p>	<p>EN-3 – 2.6.206</p>



**Table A1-23 Socio-Economics**

NPS Requirement	NPS reference
<p>The assessment should consider all relevant socio-economic impacts, which may include:</p> <ul style="list-style-type: none"> <li>• The creation of jobs and training opportunities;</li> <li>• The provision of additional local services and improvements to local infrastructure, including the provision of educational and visitor facilities;</li> <li>• Effects on tourism;</li> <li>• The impact of a changing influx of workers during the different construction, operation and decommissioning phases of the energy infrastructure; and</li> <li>• Cumulative impacts.</li> </ul>	<p>EN-1 – 5.12.3</p>

**Table A1-24 Health**

NPS Requirement	NPS reference
<p>Where the proposed project has an effect on human beings, the ES should assess these effects for each element of the project, identifying any adverse health impacts, and identifying measures to avoid, reduce or compensate for these impacts as appropriate.</p> <p>EN-1 indicates that direct impacts on health may include:</p> <ul style="list-style-type: none"> <li>• Increased traffic;</li> <li>• Air or water pollution;</li> <li>• Dust;</li> <li>• Odour;</li> <li>• Hazardous waste and substances;</li> <li>• Noise;</li> <li>• Exposure to radiation; and</li> <li>• Increase in pests.</li> </ul>	<p>EN-1 – 4.13.2</p>

**Table A1-25 Tourism and Recreation**

NPS Requirement	NPS reference
<p>This assessment should consider all relevant socio-economic impacts, which may include:</p> <ul style="list-style-type: none"> <li>• The provision of additional local services and improvements to local infrastructure, including the provision of educational and visitor facilities;</li> <li>• Effects on tourism; and</li> <li>• Cumulative impacts</li> </ul>	<p>EN-1 – 5.12.3</p>

## APPENDIX 2 FIGURES

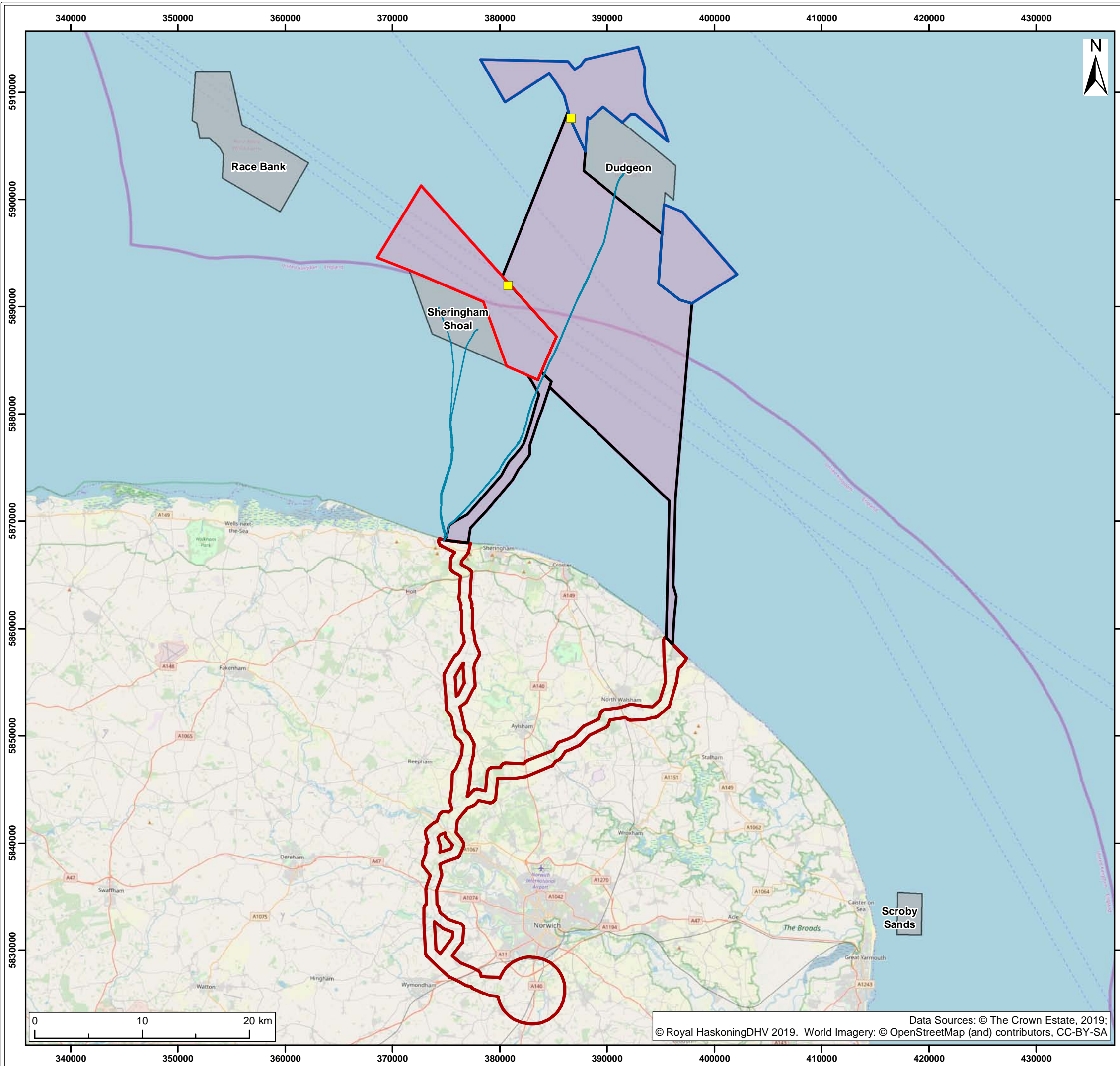

- Legend:
- Dudgeon Extension Project AfL Area
  - Sheringham Extension Project AfL Area
  - Indicative Offshore Substation Location
  - Offshore Cable Corridor
  - Offshore Scoping Area
  - Onshore Scoping Area
  - Existing Offshore Wind Farms
  - Existing Offshore Wind Farm Export Cable
  - UK 12nm limit

A1	C01	02/10/2019	Approved & accepted stage complete	LB	MW	AP
SUI	REV	DATE	DESCRIPTION	DRW	CHK	APR

Title:  
**Scoping Study Areas**

Figure: 1.1.1      Drawing No: PB8164-RHD-ZZ-XX-DR-Z-0003

Co-ordinate system: WGS 1984 UTM Zone 31N      Page Size: A3      Scale: 1:350,000

Project: Dudgeon and Sheringham Shoal Offshore Wind Farm Extensions      Report: Scoping Report





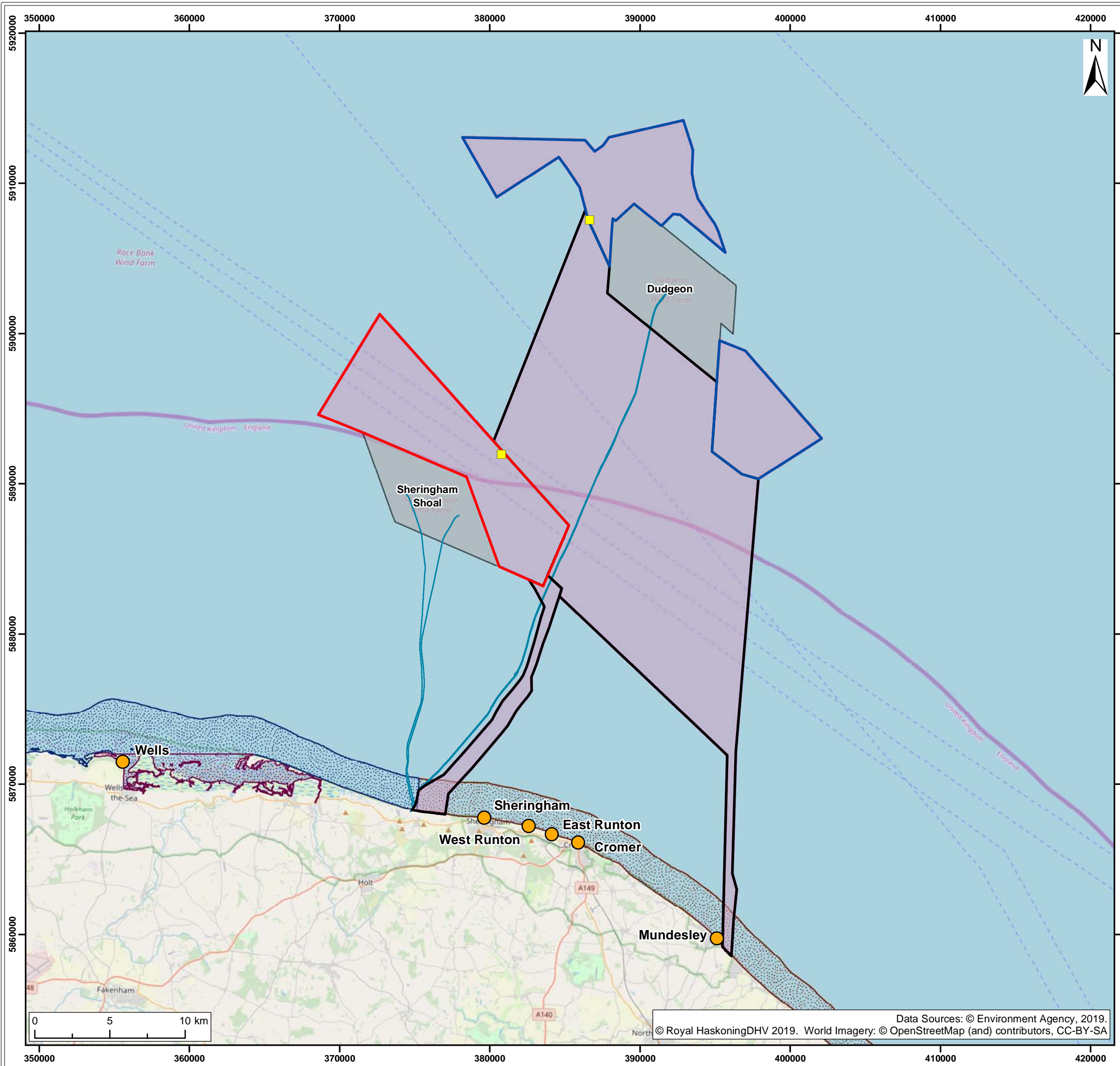

- Legend:
- Dudgeon Extension Project AfL Area
  - Sheringham Extension Project AfL Area
  - Offshore Cable Corridor
  - Offshore Scoping Area
  - Indicative Offshore Substation Location
  - Existing Offshore Wind Farm
  - Existing Offshore Wind Farm Export Cable
  - Bathing Water Monitoring Location
- WFD Transitional and Coastal Water Bodies**
- Norfolk East
  - Norfolk North
  - Stiffkey & Glaven

A1	C01	01/10/2019	Approved & accepted stage complete	LB	RS	AP
SUI	REV	DATE	DESCRIPTION	DRW	CHK	APR

Title:  
WFD water bodies and Protected Areas (Bathing Waters)

Figure: 2.2.1      Drawing No: PB8164-RHD-ZZ-OF-DR-Z-0010

Co-ordinate system: WGS 1984 UTM Zone 31N      Page Size: A3      Scale: 1:250,000

Project: Dudgeon and Sheringham Shoal Offshore Wind Farm Extensions      Report: Scoping Report





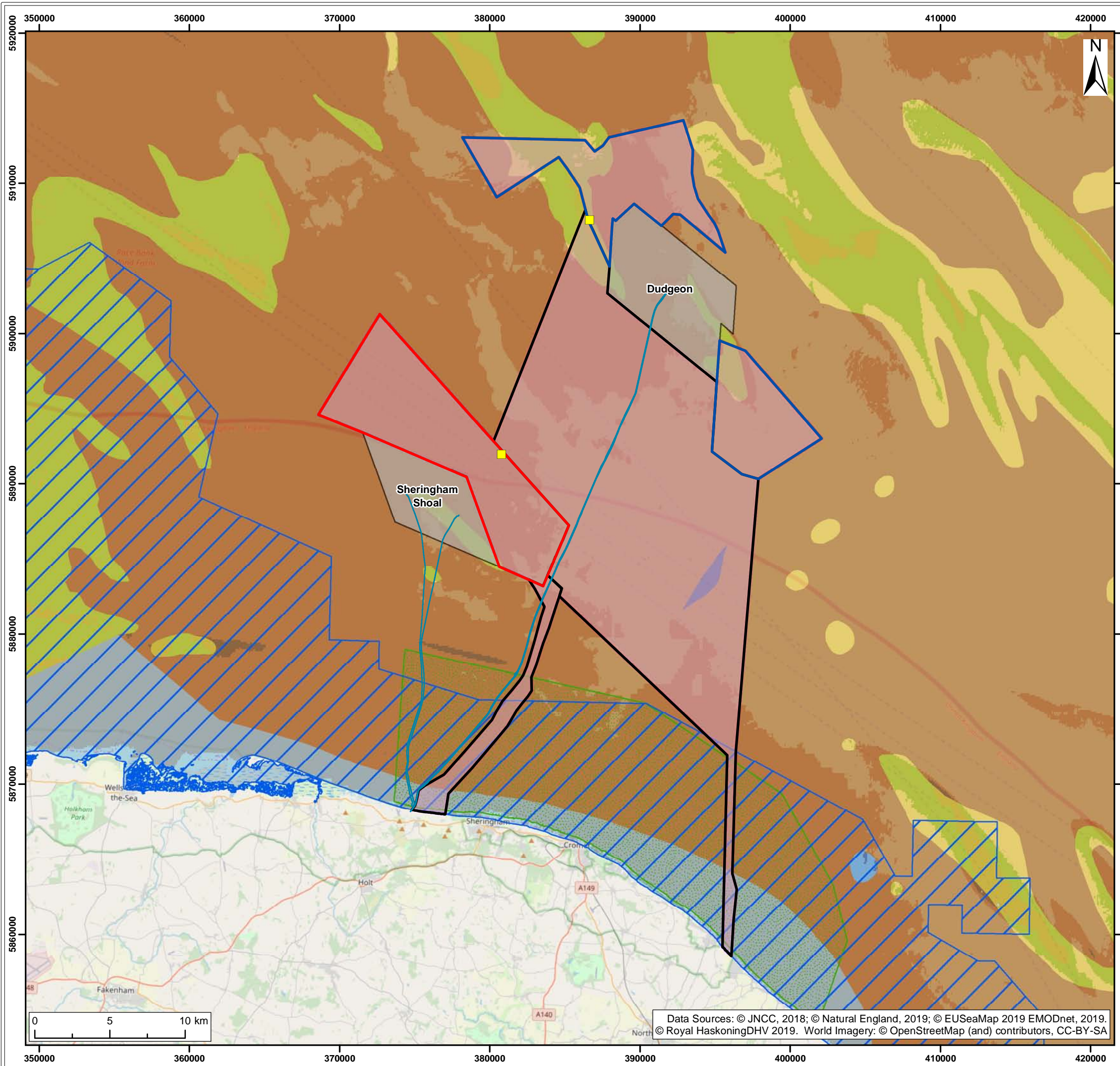

- Legend:**
- Dudgeon Extension Project AfL Area
  - Sheringham Extension Project AfL Area
  - Offshore Cable Corridor
  - Offshore Scoping Area
  - Indicative Offshore Substation Location
  - Existing Offshore Wind Farm
  - Existing Offshore Wind Farm Export Cable
  - Cromer Shoal Chalk Beds Marine Conservation Zones (MCZ)
  - Greater Wash Special Protection Area (SPA)

- EUNIS Habitat**
- A5.13: Infralittoral coarse sediment
  - A5.14: Circalittoral coarse sediment
  - A5.15: Deep circalittoral coarse sediment
  - A5.23 or A5.24: Infralittoral fine sand or Infralittoral muddy sand
  - A5.25 or A5.26: Circalittoral fine sand or Circalittoral muddy sand
  - A5.27: Deep circalittoral sand
  - A5.44: Circalittoral mixed sediments
  - A5.45: Deep circalittoral mixed sediments
  - No EUNIS habitat assigned

A1	C01	01/10/2019	Approved & accepted stage complete	LB	RS	AP
SUI	REV	DATE	DESCRIPTION	DRW	CHK	APR

Title:  
**Marine Designated Sites and Habitats**

Figure: 2.3.1      Drawing No: PB8164-RHD-ZZ-OF-DR-Z-0005

Co-ordinate system: WGS 1984 UTM Zone 31N      Page Size: A3      Scale: 1:250,000

Project: Dudgeon and Sheringham Shoal Offshore Wind Farm Extensions      Report: Scoping Report

Data Sources: © JNCC, 2018; © Natural England, 2019; © EUSeaMap 2019 EMODnet, 2019. © Royal HaskoningDHV 2019. World Imagery: © OpenStreetMap (and) contributors, CC-BY-SA









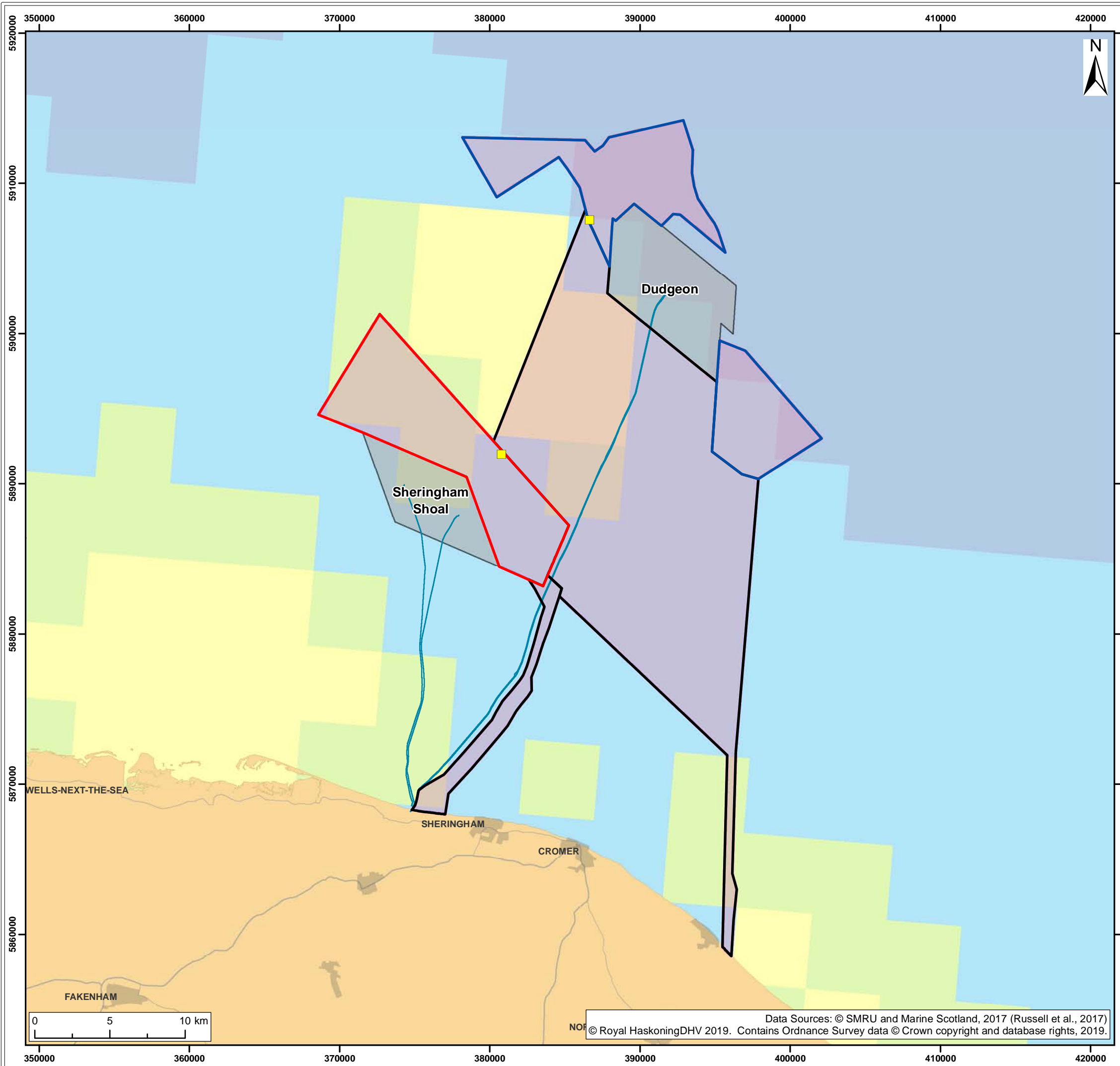

- Legend:
- Dudgeon Extension Project AfL Area
  - Sheringham Extension Project AfL Area
  - Offshore Cable Corridor
  - Offshore Scoping Area
  - Indicative Offshore Substation Location
  - Existing Offshore Wind Farm
  - Existing Offshore Wind Farm Export Cable

- Grey Seal at-sea Usage**
- Density of seals per 25km<sup>2</sup>*
- 0-1
  - 1-5
  - 5-10
  - 10-50
  - 50-100
  - 100-150
  - 150+

A1	C01	01/10/2019	Approved & accepted stage complete	LB	RS	AP
SUI	REV	DATE	DESCRIPTION	DRW	CHK	APR

Title:  
**Grey Seal Density**

Figure: 2.5.1      Drawing No: PB8164-RHD-ZZ-OF-DR-Z-0008

Co-ordinate system: WGS 1984 UTM Zone 31N      Page Size: A3      Scale: 1:250,000

Project: Dudgeon and Sheringham Shoal Offshore Wind Farm Extensions      Report: Scoping Report



Data Sources: © SMRU and Marine Scotland, 2017 (Russell et al., 2017)  
© Royal HaskoningDHV 2019. Contains Ordnance Survey data © Crown copyright and database rights, 2019.





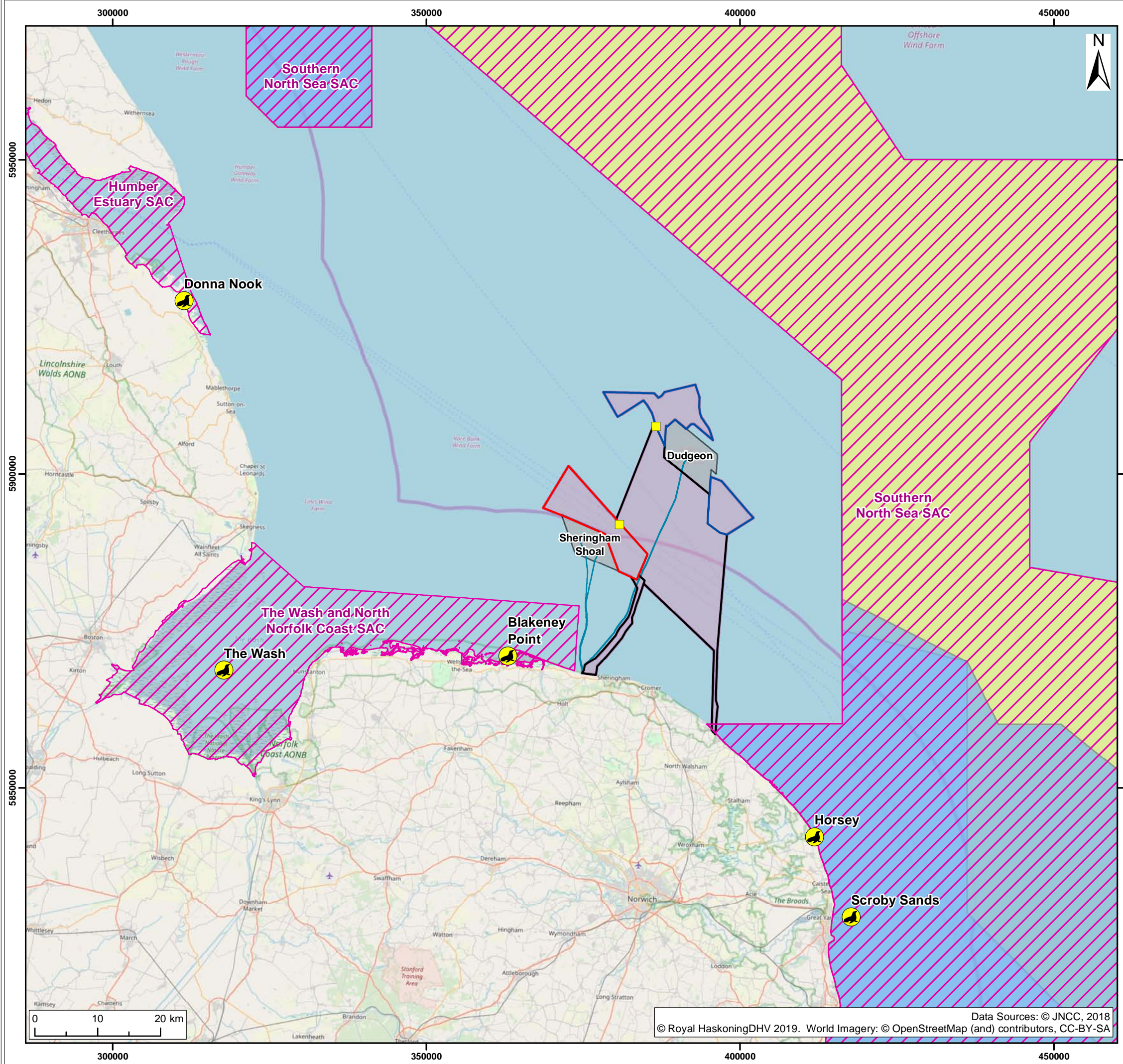

- Legend:
- Dudgeon Extension Project AfL Area
  - Sheringham Extension Project AfL Area
  - Offshore Cable Corridor
  - Offshore Scoping Area
  - Indicative Offshore Substation Location
  - Existing Offshore Wind Farm
  - Existing Offshore Wind Farm Export Cable
  - Special Area of Conservation (SAC)
  - Summer Area
  - Winter Area
  - Seal Haul Out Area

A1	C01	01/10/2019	Approved & accepted stage complete	LB	RS	AP
SUI	REV	DATE	DESCRIPTION	DRW	CHK	APR

Title:  
**Marine Mammal Special Areas of Conservation (SAC) and Seal Haul Out Sites**

Figure: 2.5.3      Drawing No: PB8164-RHD-ZZ-OF-DR-Z-0007

Co-ordinate system: WGS 1984 UTM Zone 31N      Page Size: A3      Scale: 1:600,000

Project: Dudgeon and Sheringham Shoal Offshore Wind Farm Extensions      Report: Scoping Report





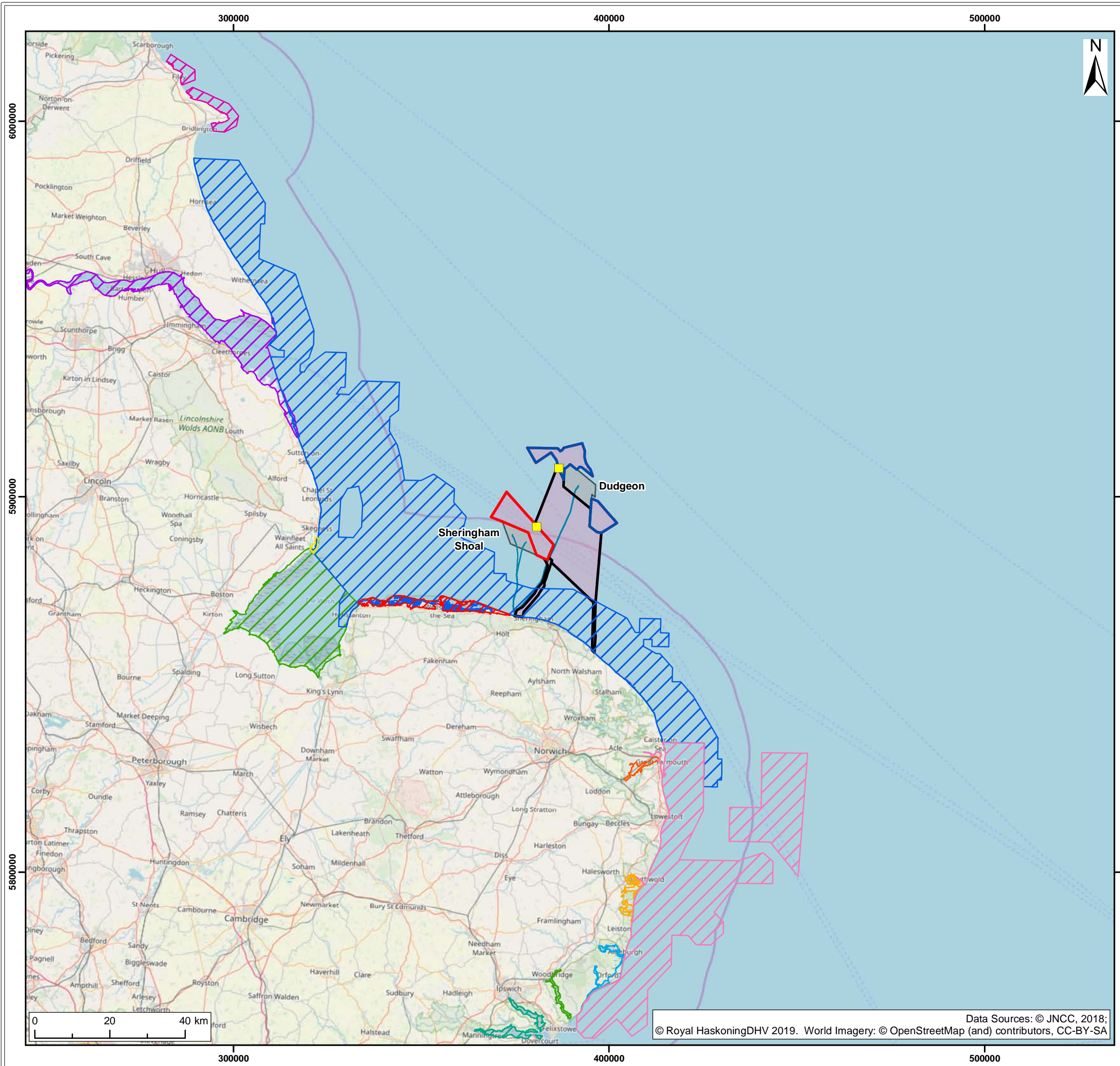

- Legend:**
- Dudgeon Extension Project AfL Area
  - Sheringham Extension Project AfL Area
  - Offshore Cable Corridor
  - Offshore Scoping Area
  - Indicative Offshore Substation Location
  - Existing Offshore Wind Farm
  - Existing Offshore Wind Farm Export Cable
- Special Protection Areas (SPA)**
- Alde-Ore Estuary
  - Breydon Water
  - Deben Estuary
  - Flamborough and Filey Coast
  - Gibraltar Point
  - Greater Wash
  - Humber Estuary
  - Minsmere-Walberswick
  - North Norfolk Coast
  - Outer Thames Estuary
  - Stour and Orwell Estuaries
  - The Wash

A1	C01	01/10/2019	Approved & accepted stage complete	LB	RS	AP
SUI	REV	DATE	DESCRIPTION	DRW	CHK	APR

Title:  
 SPAs located near the Dudgeon and Sheringham Shoal Extensions

Figure: 2.6.1      Drawing No: PB8164-RHD-ZZ-OF-DR-Z-0006

Co-ordinate system: WGS 1984 UTM Zone 31N      Page Size: A3      Scale: 1:1,000,000

Project: Dudgeon and Sheringham Shoal Offshore Wind Farm Extensions      Report: Scoping Report





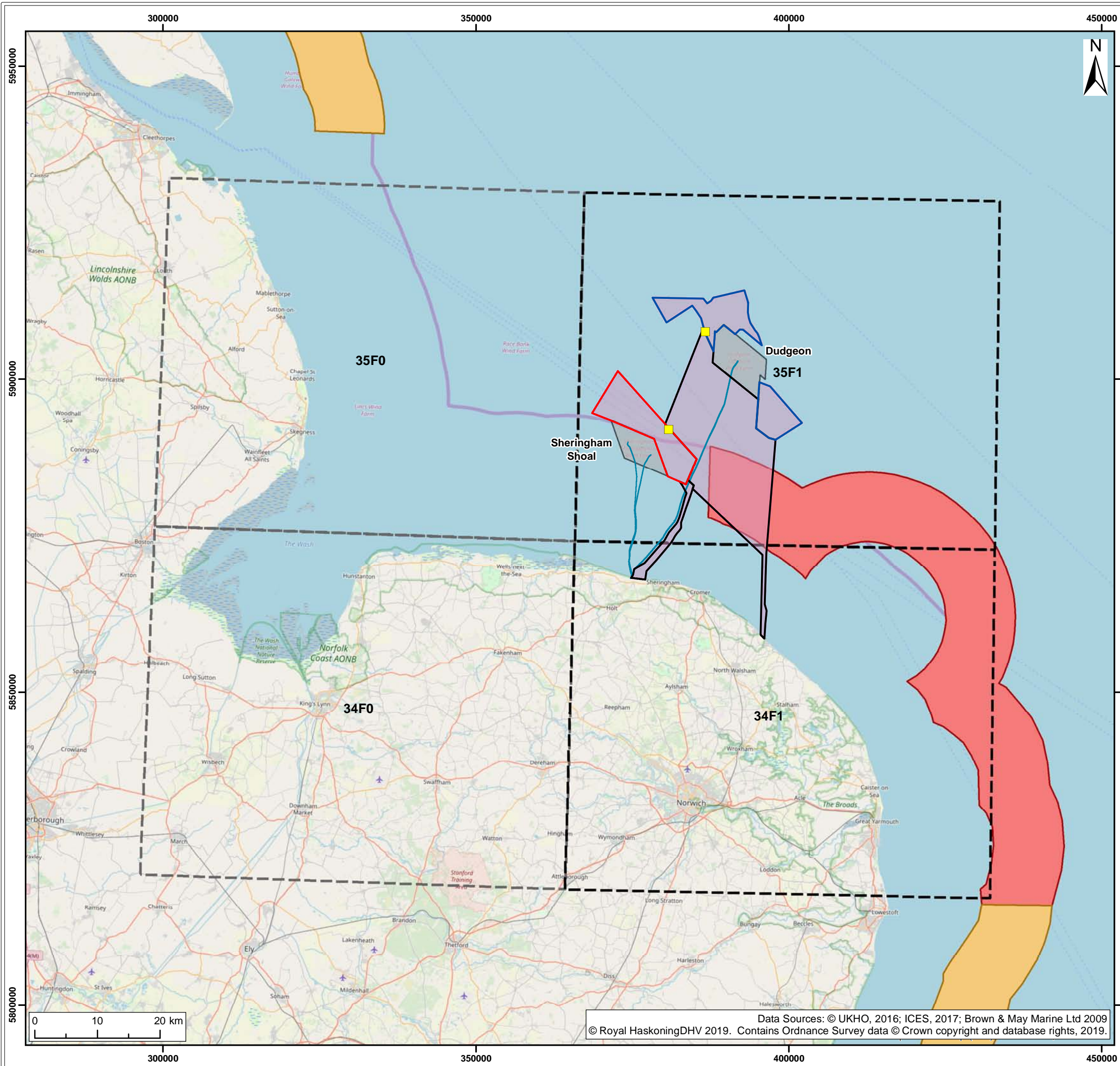

- Legend:
- Dudgeon Extension Project AfL Area
  - Sheringham Extension Project AfL Area
  - Offshore Cable Corridor
  - Offshore Scoping Area
  - Indicative Offshore Substation Location
  - Existing Offshore Wind Farm
  - Existing Offshore Wind Farm Export Cable
  - Regional Study Area
  - Local Study Area
- Historic Fishing Rights**
- Belgian
  - French

A1	C01	01/10/2019	Approved & accepted stage complete	LB	RS	AP
SUI	REV	DATE	DESCRIPTION	DRW	CHK	APR

Title:  
**Historic Fishing Rights**

Figure: 2.7.1      Drawing No: PB8164-RHD-ZZ-OF-DR-Z-0013

Co-ordinate system: WGS 1984 UTM Zone 31N      Page Size: A3      Scale: 1:600,000

Project: **Dudgeon and Sheringham Shoal Offshore Wind Farm Extensions**      Report: **Scoping Report**

Data Sources: © UKHO, 2016; ICES, 2017; Brown & May Marine Ltd 2009  
© Royal HaskoningDHV 2019. Contains Ordnance Survey data © Crown copyright and database rights, 2019.





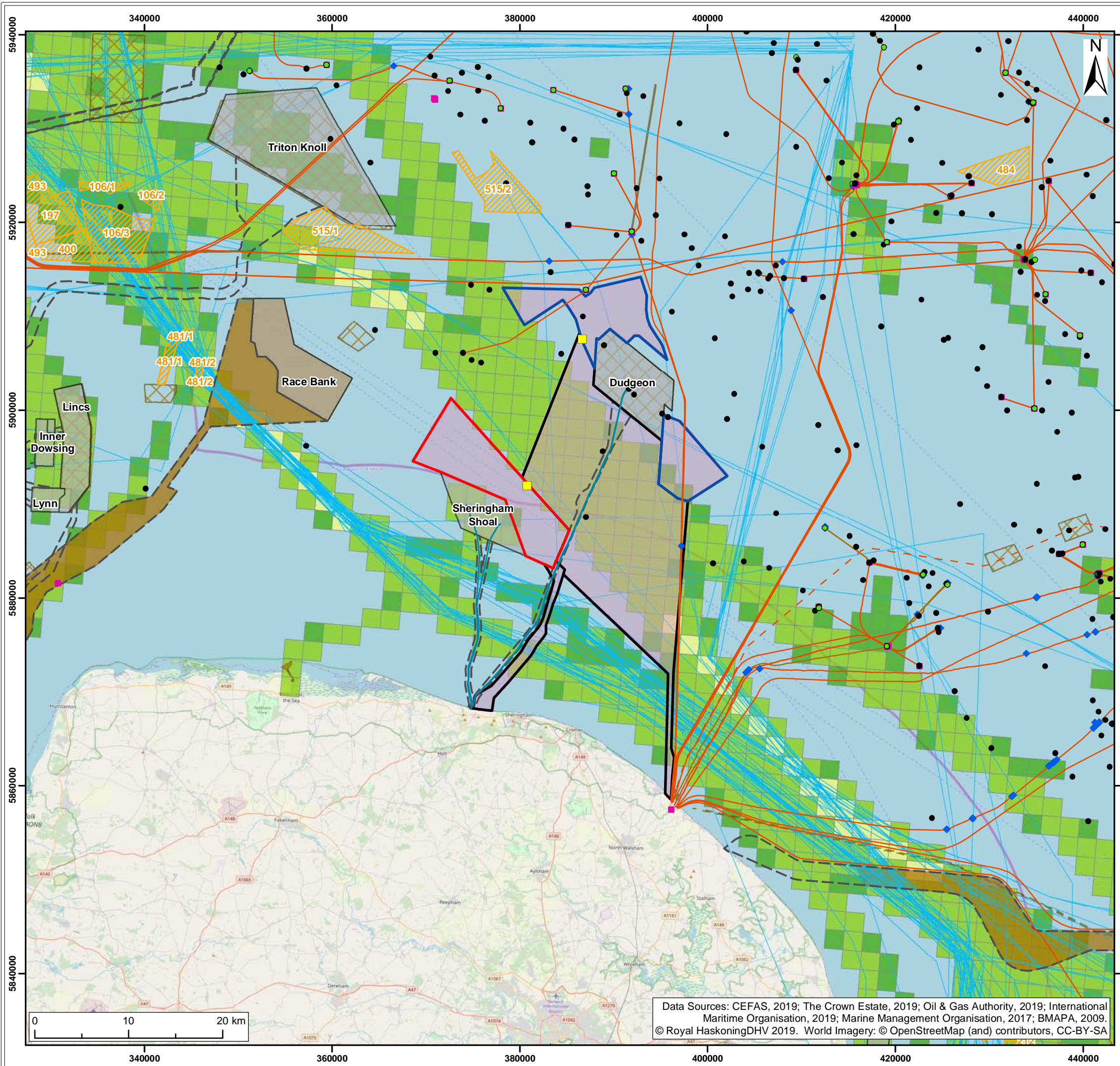

- Legend:**
- Dudgeon Extension Project AfL Area
  - Sheringham Extension Project AfL Area
  - Offshore Cable Corridor
  - Offshore Scoping Area
  - Indicative Offshore Substation Location
  - Existing Offshore Wind Farm
  - Existing Offshore Wind Export Cable Corridor
  - Existing Offshore Wind Farm Export Cable
  - Disposal Sites
  - Open
  - Closed
  - Disused
- Aggregate Areas**
- Aggregate Production Area
  - Dredger Transit Route
- Oil & Gas Infrastructure**
- Surface Infrastructure (Active)
  - ◆ Subsurface Infrastructure (Active)
- Wells**
- Abandoned/Plugged
  - Completed
  - Drilling
- Pipelines**
- Active
  - Not in use
  - Precommission

A1	C01	01/10/2019	Approved & accepted stage complete	LB	RS	AP
SUI	REV	DATE	DESCRIPTION	DRW	CHK	APR

Title:  
Shipping and Navigation activities

Figure: 2.8.1      Drawing No: PB8164-RHD-ZZ-OF-DR-Z-0011

Co-ordinate system: WGS 1984 UTM Zone 31N      Page Size: A3      Scale: 1:400,000

Project: Dudgeon and Sheringham Shoal Offshore Wind Farm Extensions      Report: Scoping Report

Data Sources: CEFAS, 2019; The Crown Estate, 2019; Oil & Gas Authority, 2019; International Maritime Organisation, 2019; Marine Management Organisation, 2017; BMAPA, 2009.  
© Royal HaskoningDHV 2019. World Imagery: © OpenStreetMap (and) contributors, CC-BY-SA





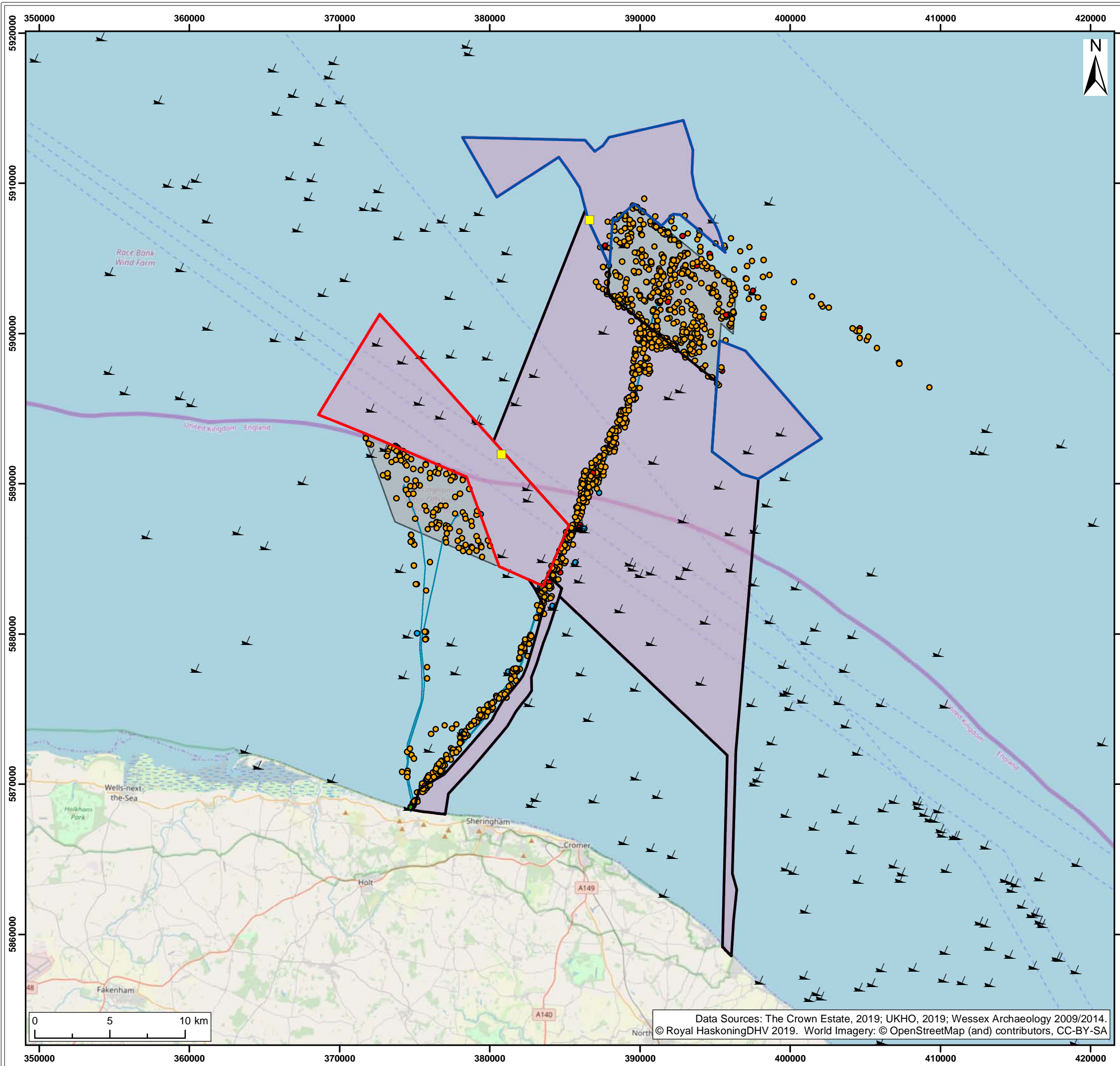

- Legend:**
- Dudgeon Extension Project AfL Area
  - Sheringham Extension Project AfL Area
  - Offshore Cable Corridor
  - Offshore Scoping Area
  - Indicative Offshore Substation Location
  - Existing Offshore Wind Farm
  - Existing Offshore Wind Farm Export Cable
  - UKHO Wreck
- Seabed Features**
- A1
  - A2
  - A3
  - O1

A1	C01	01/10/2019	Approved & accepted stage complete	LB	RS	AP
SUI	REV	DATE	DESCRIPTION	DRW	CHK	APR

Title:  
**Seabed Features from Previous Archaeological Assessments**

Figure: 2.9.1      Drawing No: PB8164-RHD-ZZ-OF-DR-Z-0018

Co-ordinate system: WGS 1984 UTM Zone 31N	Page Size: A3	Scale: 1:250,000
--	------------------	---------------------

Project: Dudgeon and Sheringham Shoal Offshore Wind Farm Extensions	Report: Scoping Report
--	---------------------------

Data Sources: The Crown Estate, 2019; UKHO, 2019; Wessex Archaeology 2009/2014.  
 © Royal HaskoningDHV 2019. World Imagery: © OpenStreetMap (and) contributors, CC-BY-SA





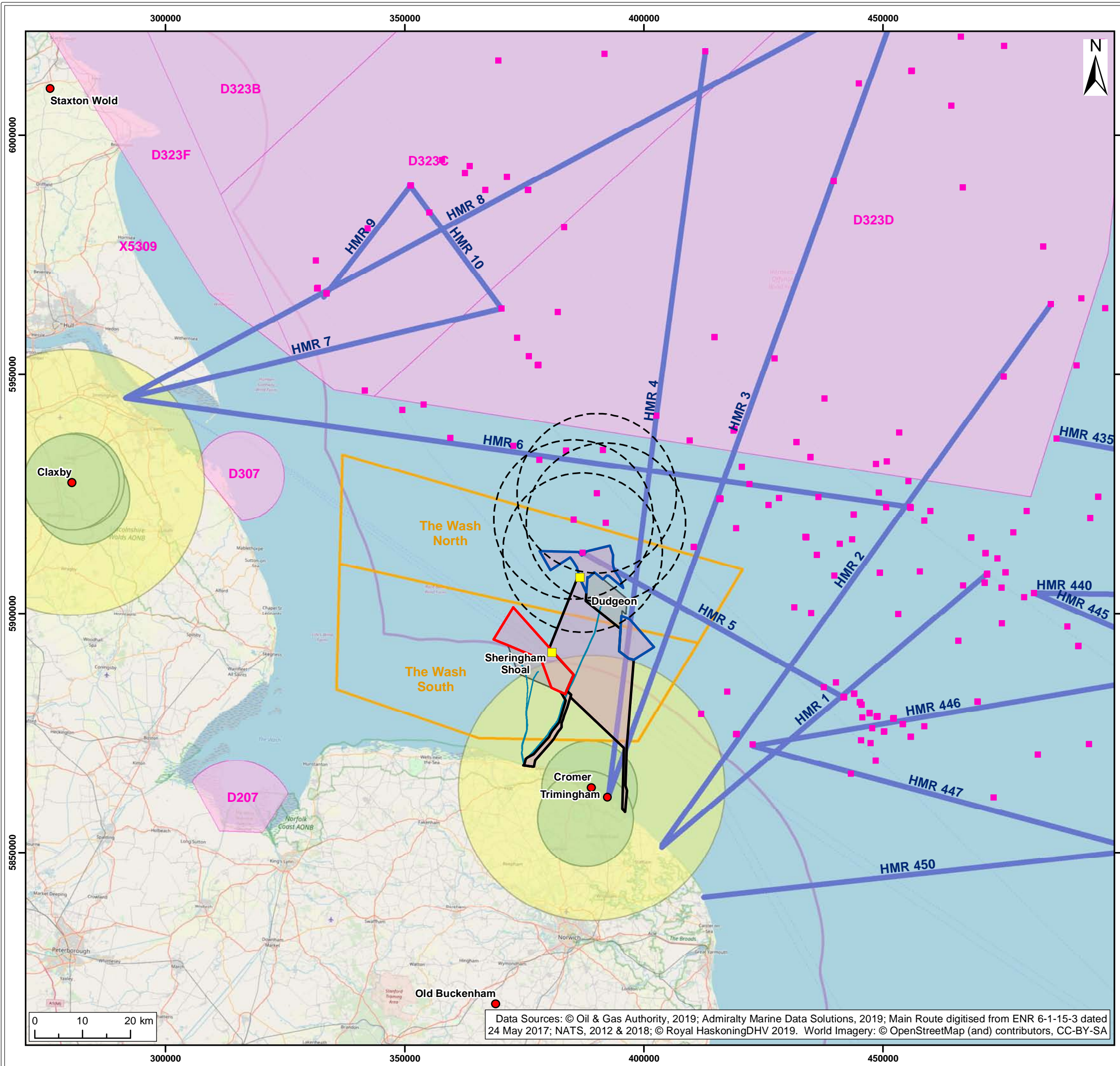

- Legend:
- Dudgeon Extension Project AfL Area
  - Sheringham Extension Project AfL Area
  - Offshore Cable Corridor
  - Offshore Scoping Area
  - Indicative Offshore Substation Location
  - Existing Offshore Wind Farm
  - Existing Offshore Wind Farm Export Cable
  - UK PEXA
  - Aerial Tactics Areas
  - 9NM Consultation Zone
  - Offshore Platforms
  - Helicopter Main Routes (HMR)
  - Radar Station Location
  - Air-Ground-Air Communication Site - 10km Safeguarded Zone
  - Secondary Surveillance Radar (SSR) - 15nm Safeguarded Zone

A1	C01	01/10/2019	Approved & accepted stage complete	LB	RS	AP
SUI	REV	DATE	DESCRIPTION	DRW	CHK	APR

Title:  
Aviation and MoD Receptors

Figure: 2.10.1 | Drawing No: PB8164-RHD-ZZ-OF-DR-Z-0012

Co-ordinate system: WGS 1984 UTM Zone 31N | Page Size: A3 | Scale: 1:785,000

Project: Dudgeon and Sheringham Shoal Offshore Wind Farm Extensions | Report: Scoping Report



Data Sources: © Oil & Gas Authority, 2019; Admiralty Marine Data Solutions, 2019; Main Route digitised from ENR 6-1-15-3 dated 24 May 2017; NATS, 2012 & 2018; © Royal HaskoningDHV 2019. World Imagery: © OpenStreetMap (and) contributors, CC-BY-SA



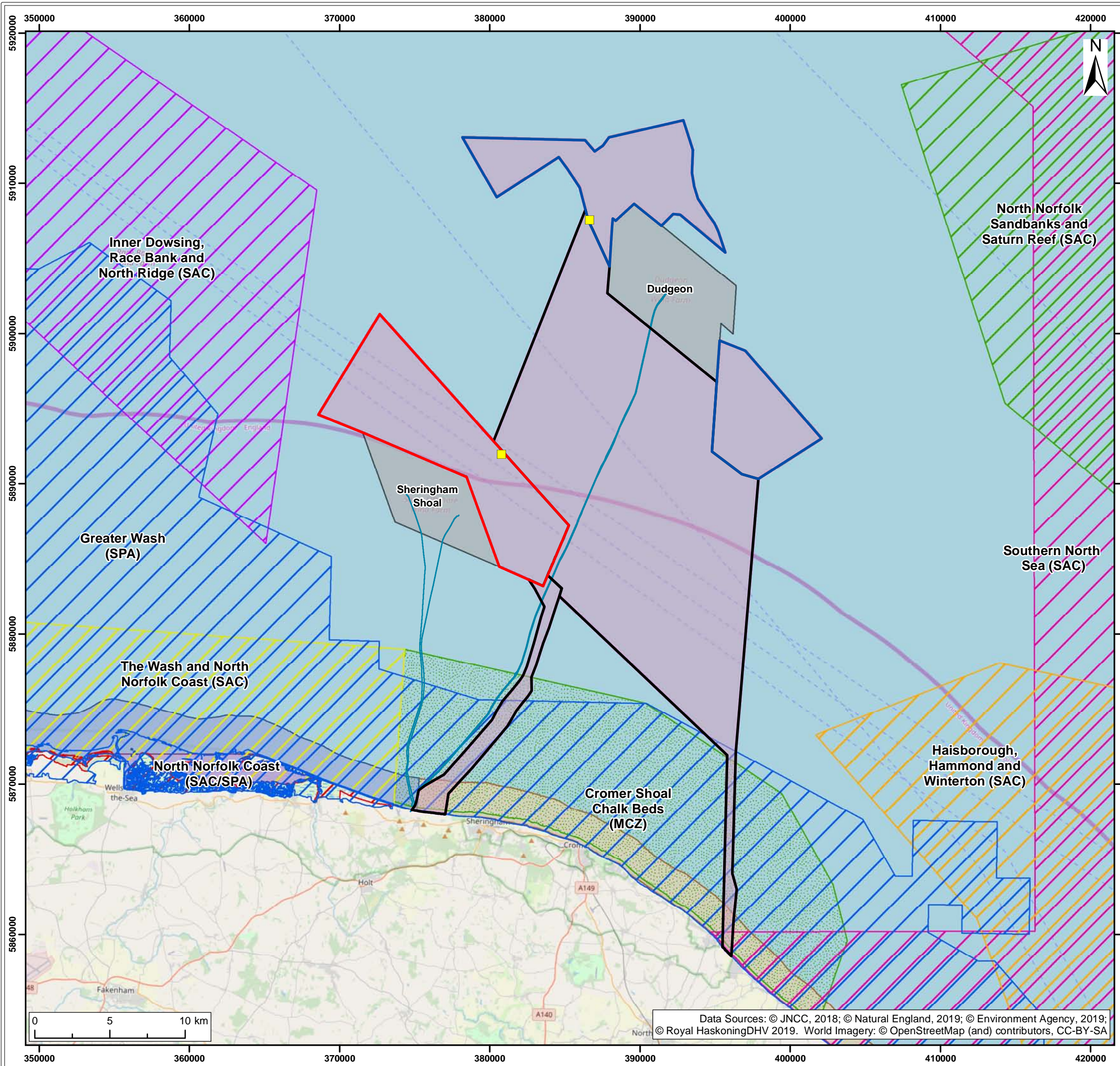

- Legend:**
- Dudgeon Extension Project AfL Area
  - Sheringham Extension Project AfL Area
  - Offshore Cable Corridor
  - Offshore Scoping Area
  - Indicative Offshore Substation Location
  - Existing Offshore Wind Farm
  - Existing Offshore Wind Farm Export Cable
  - Marine Conservation Zone (MCZ)
  - Special Protection Area (SPA)
- Special Area of Conservation (SAC)**
- Haisborough, Hammond and Winterton
  - Inner Dowsing, Race Bank and North Ridge
  - North Norfolk Coast
  - North Norfolk Sandbanks and Saturn Reef
  - Southern North Sea
  - The Wash and North Norfolk Coast
- WFD Transitional and Coastal Water Bodies**
- Norfolk East
  - Norfolk North
  - Stiffkey & Glaven

A1	C01	01/10/2019	Approved & accepted stage complete	LB	RS	AP					
SUI	REV	DATE	DESCRIPTION	DRW	CHK	APR					

Title:  
**Offshore Designated Sites**

Figure: 2.11.1 | Drawing No: PB8164-RHD-ZZ-OF-DR-Z-0016

Co-ordinate system: WGS 1984 UTM Zone 31N | Page Size: A3 | Scale: 1:250,000

Project: Dudgeon and Sheringham Shoal Offshore Wind Farm Extensions | Report: Scoping Report

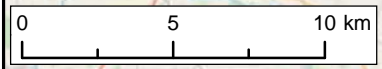

Data Sources: © JNCC, 2018; © Natural England, 2019; © Environment Agency, 2019; © Royal HaskoningDHV 2019. World Imagery: © OpenStreetMap (and) contributors, CC-BY-SA





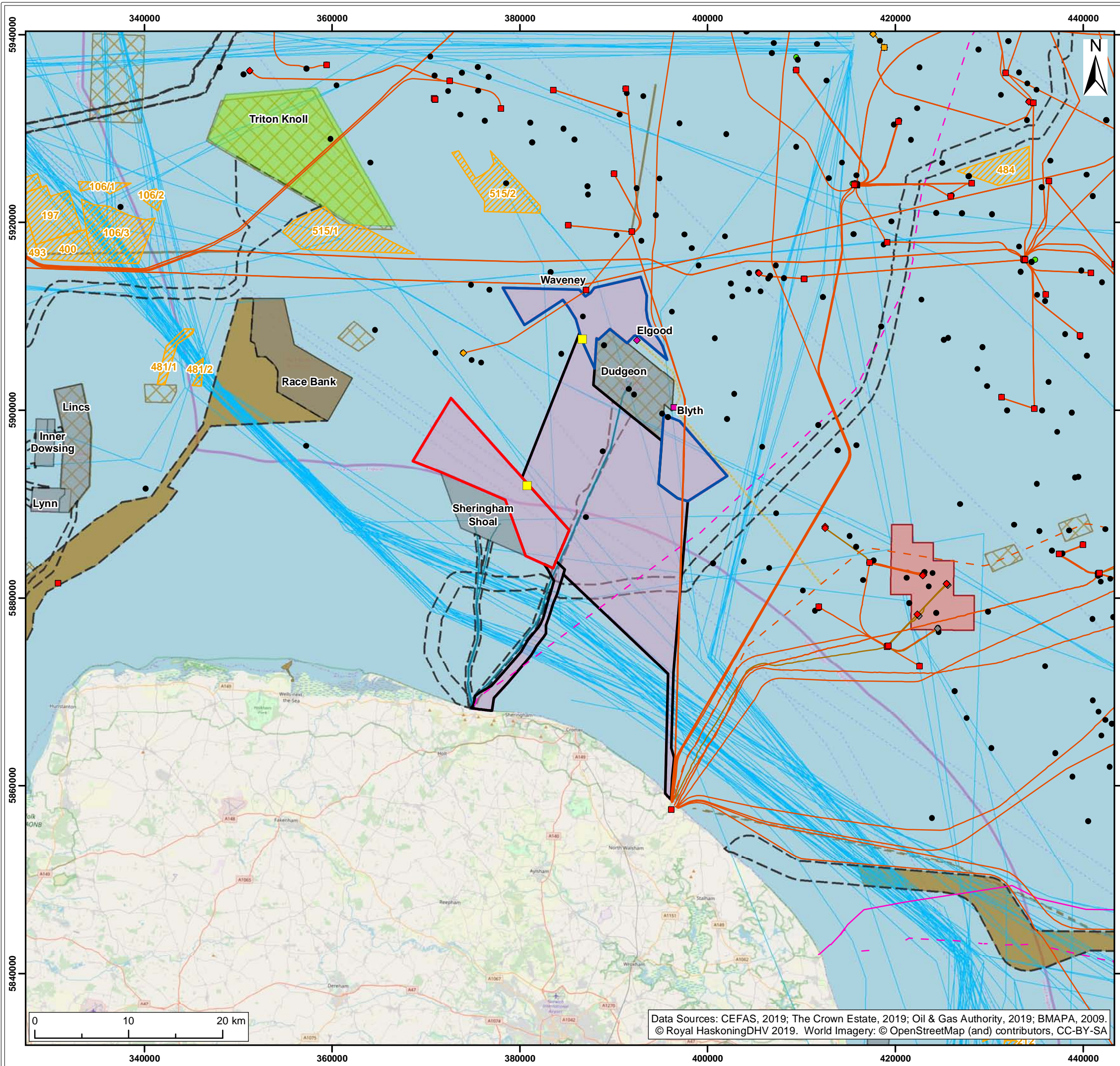

**Legend:**

Dudgeon Extension Project AfL Area	<b>Oil &amp; Gas Infrastructure</b>
Sheringham Extension Project AfL Area	<i>Surface Infrastructure</i>
Offshore Cable Corridor	Active
Offshore Scoping Area	Precommission
Indicative Offshore Substation Location	Proposed
<b>Offshore Wind Farm</b>	<i>Subsurface Infrastructure (wellheads and manifolds)</i>
Consented	Active
In operation	Precommission
Existing Offshore Wind Export Cable Corridor	Not In Use
Existing Offshore Wind Farm Export Cable	Proposed
<b>Disposal Sites</b>	<b>Wells</b>
Open	Abandoned/Plugged
Closed	Completed
Disused	Drilling
<b>Aggregate Areas</b>	<i>Pipelines</i>
Aggregate Production Area	Active
Dredger Transit Route	Precommission
Gas Storage Lease Area	Not in use
	Proposed
	<b>Cables</b>
	Active
	Disused

A1	C01	02/10/2019	Approved & accepted stage complete	LB	RS	AP
SUI	REV	DATE	DESCRIPTION	DRW	CHK	APR

Title:  
Other Marine Users

Figure: 2.13.1 | Drawing No: PB8164-RHD-ZZ-OF-DR-Z-0017

Co-ordinate system: WGS 1984 UTM Zone 31N | Page Size: A3 | Scale: 1:400,000

Project: Dudgeon and Sheringham Shoal Offshore Wind Farm Extensions | Report: Scoping Report

Data Sources: CEFAS, 2019; The Crown Estate, 2019; Oil & Gas Authority, 2019; BMAPA, 2009. © Royal HaskoningDHV 2019. World Imagery: © OpenStreetMap (and) contributors, CC-BY-SA





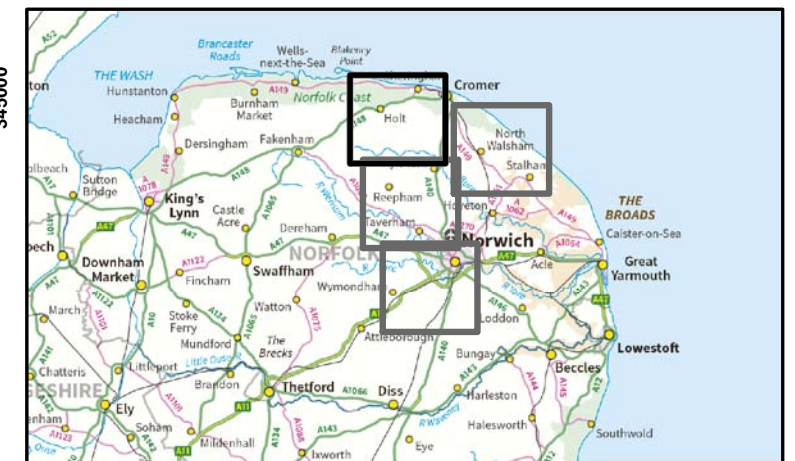
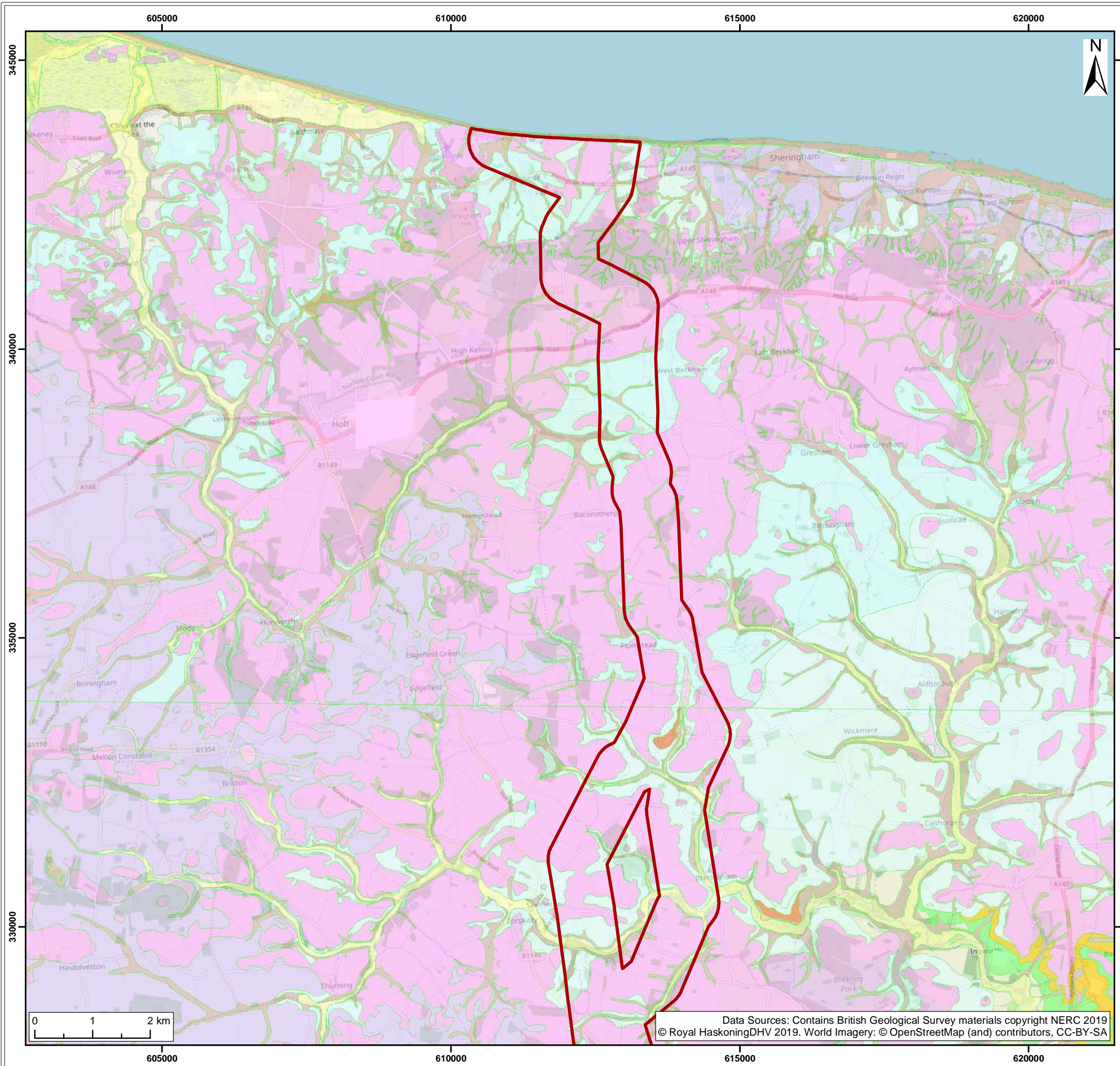

- Legend:
- Onshore Scoping Area
  - Superficial Geology**
  - Alluvium - Clay, Silt, Sand, Gravel
  - Bacton Green Till Member - Diamicton
  - Briton's Lane Sand and Gravel Member - Sand and Gravel
  - Glaciofluvial Deposits, Mid Pleistocene - Sand and Gravel
  - Happisburgh Glacigenic Formation - Diamicton
  - Happisburgh Glacigenic FOrmation - Sand and Gravel
  - Head - Gravel, Sand, silt and Clay
  - Lowestoft Formation - Sand and Gravel
  - Marine Beach Deposits - Sand and Gravel
  - Peat - Peat
  - Reclaimed Intertidal Deposits - Silt and Clay
  - River Terrace Deposits, 1 - Sand and Gravel
  - Sheringham Cliffs Formation - Clay, Silt, Sand and Gravel
  - Storm Beach Deposits - Gravel, Sand and Silt
  - Tidal Flat Deposits - Gravel, Sand, Silt and Clay
  - Weybourne Town Till Member - Diamicton

A1	C01	02/10/2019	Approved & accepted stage complete	LB	MW	AP
SUI	REV	DATE	DESCRIPTION	DRW	CHK	APR

Title:  
Superficial Geology

Figure: 3.1.1a | Drawing No: PB8164-RHD-ZZ-ON-DR-Z-0023

Co-ordinate system: British National Grid | Page Size: A3 | Scale: 1:65,000

Project: Dudgeon and Sheringham Shoal Offshore Wind Farm Extensions | Report: Scoping Report



Data Sources: Contains British Geological Survey materials copyright NERC 2019 © Royal HaskoningDHV 2019. World Imagery: © OpenStreetMap (and) contributors, CC-BY-SA



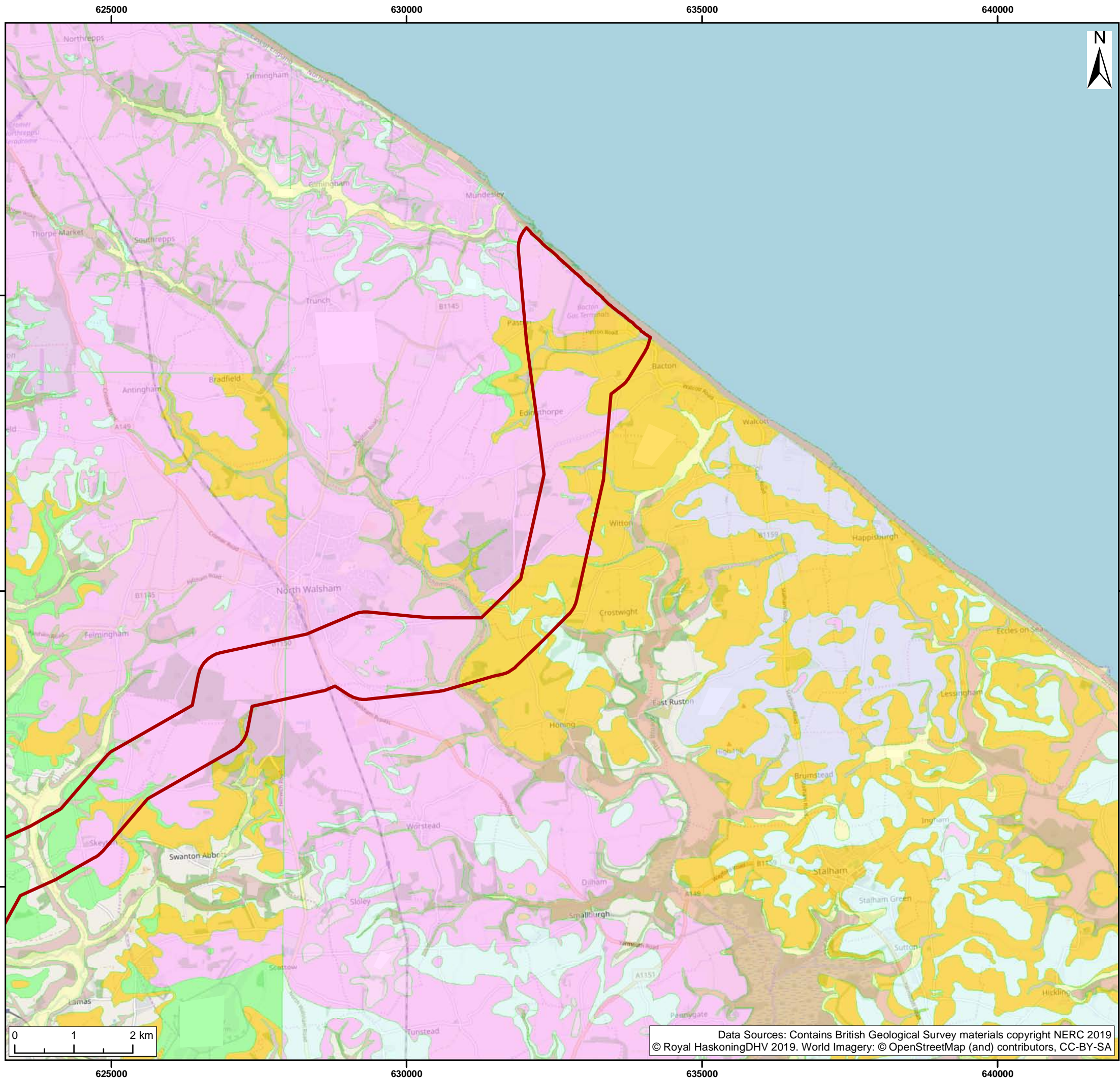

Data Sources: Contains British Geological Survey materials copyright NERC 2019  
 © Royal HaskoningDHV 2019. World Imagery: © OpenStreetMap (and) contributors, CC-BY-SA

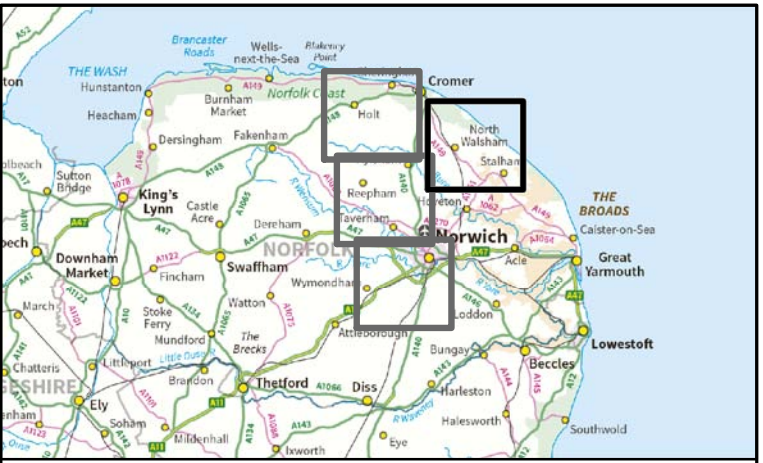

Legend:

Onshore Scoping Area

**Superficial Geology**

- Alluvium - Clay, Silt, Sand, Gravel
- Bacton Green Till Member - Diamicton
- Blown Sand - Sand
- Breydon Formation - Clay and Silt
- Breydon Formation - Peat
- Briton's Lane Sand and Gravel Member - Sand and Gravel
- Coastal Barrier Deposits - Sand and Gravel
- Happisburgh Glacigenic Formation - Diamicton
- Happisburgh Glacigenic FOrmation - Sand and Gravel
- Head - Clay, Silt, Sand and Gravel
- Marine Beach Deposits - Sand and Gravel
- River Terrace Deposits (Undifferentiated) - Sand and Gravel
- Sand and Gravel of Uncertain Age and Origin - Sand and Gravel
- Trimmingham Sand Member - Sand and Gravel
- Walcott Till Member - Diamicton

A1	C01	02/10/2019	Approved & accepted stage complete	LB	MW	AP
SUI	REV	DATE	DESCRIPTION	DRW	CHK	APR

Title:  
 Superficial Geology

Figure: 3.1.1a | Drawing No: PB8164-RHD-ZZ-ON-DR-Z-0023

Co-ordinate system: British National Grid | Page Size: A3 | Scale: 1:65,000

Project: Dudgeon and Sheringham Shoal Offshore Wind Farm Extensions | Report: Scoping Report





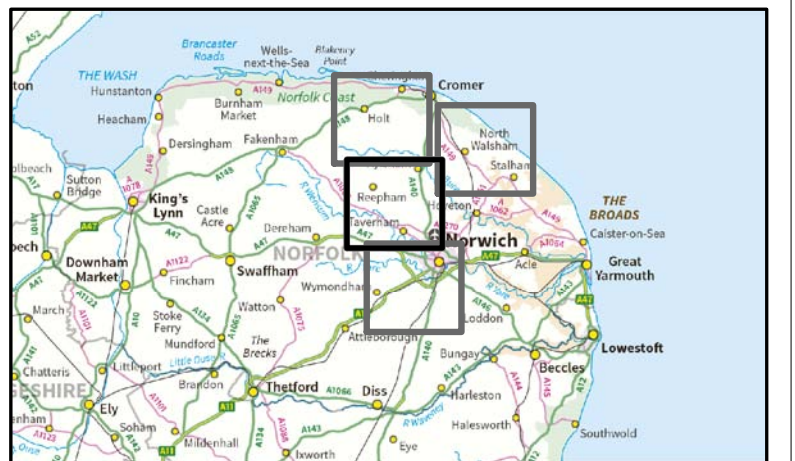
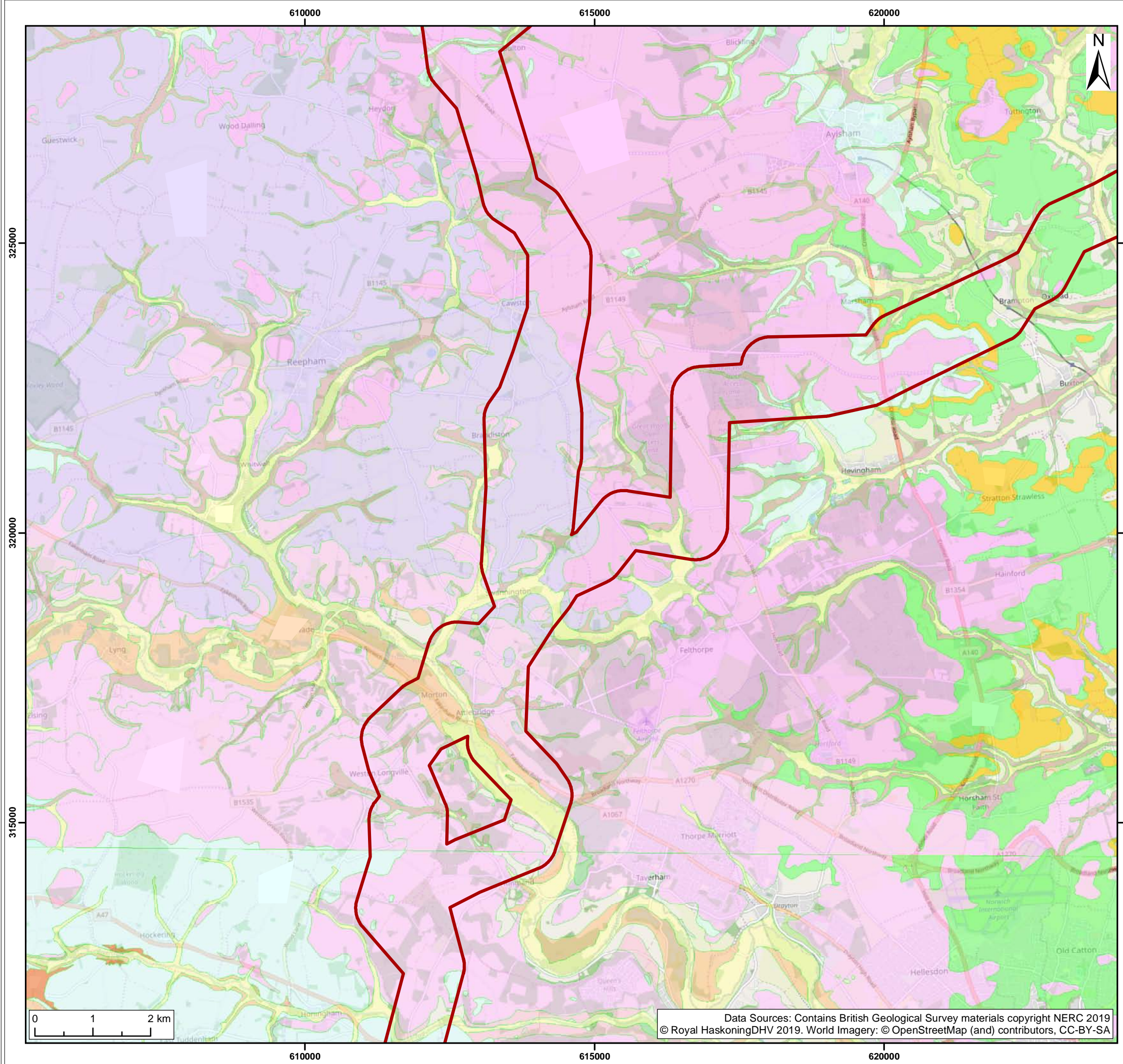

- Legend:
- Onshore Scoping Area
  - Superficial Geology**
  - Alluvium - Clay, Silt, Sand, Gravel
  - Briton's Lane Sand and Gravel Member - Sand and Gravel
  - Happisburgh Glacigenic Formation - Diamicton
  - Happisburgh Glacigenic FOrmation - Sand and Gravel
  - Head - Clay, Silt, Sand and Gravel
  - Lowestoft Formation - Diamicton
  - Lowestoft Formation - Sand and Gravel
  - River Terrace Deposits, 1 - Sand and Gravel
  - Sheringham Cliffs Formation - Clay, Silt, Sand and Gravel
  - Sheringham Cliffs Formation - Sand
  - Sheringham Cliffs Formation - Sand and Gravel

A1	C01	02/10/2019	Approved & accepted stage complete	LB	MW	AP
SUI	REV	DATE	DESCRIPTION	DRW	CHK	APR

Title:  
 Superficial Geology

Figure: 3.1.1a | Drawing No: PB8164-RHD-ZZ-ON-DR-Z-0023

Co-ordinate system: British National Grid	Page Size: A3	Scale: 1:65,000
--	------------------	--------------------

Project: Dudgeon and Sheringham Shoal Offshore Wind Farm Extensions	Report: Scoping Report
--	---------------------------



Data Sources: Contains British Geological Survey materials copyright NERC 2019  
 © Royal HaskoningDHV 2019. World Imagery: © OpenStreetMap (and) contributors, CC-BY-SA



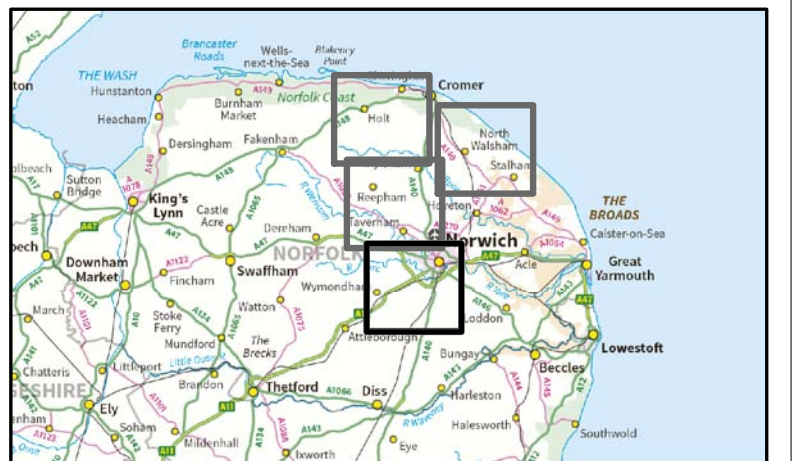
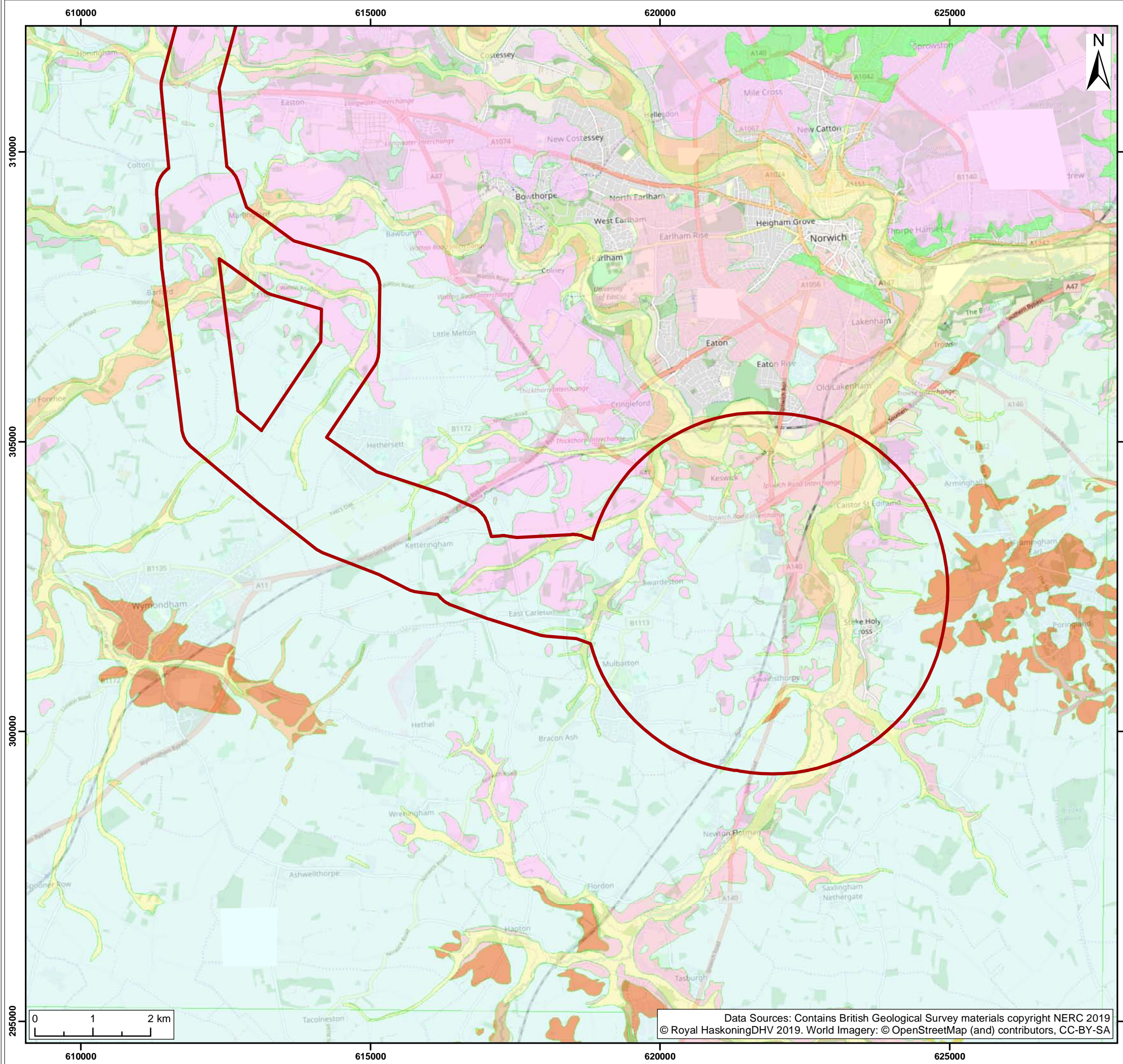

- Legend:
- Onshore Scoping Area
  - Superficial Geology**
  - Alluvium - Clay, Silt, Sand, Gravel
  - Happisburgh Glacigenic Formation - Diamicton
  - Happisburgh Glacigenic Formation and Lowestoft Formation (Undifferentiated) - Sand and Gravel
  - Leet Hill Sand and Gravel Member - Sand and Gravel
  - Lowestoft Formation - Diamicton
  - Lowestoft Formation - Sand and Gravel
  - Peat - Peat
  - River Terrace Deposits, 1 - Sand and Gravel
  - Sheringham Cliffs Formation - Sand and Gravel

A1	C01	02/10/2019	Approved & accepted stage complete	LB	MW	AP
SUI	REV	DATE	DESCRIPTION	DRW	CHK	APR

Title:  
 Superficial Geology

Figure: 3.1.1a | Drawing No: PB8164-RHD-ZZ-ON-DR-Z-0023

Co-ordinate system: British National Grid | Page Size: A3 | Scale: 1:65,000

Project: Dudgeon and Sheringham Shoal Offshore Wind Farm Extensions | Report: Scoping Report



Data Sources: Contains British Geological Survey materials copyright NERC 2019  
 © Royal HaskoningDHV 2019. World Imagery: © OpenStreetMap (and) contributors, CC-BY-SA



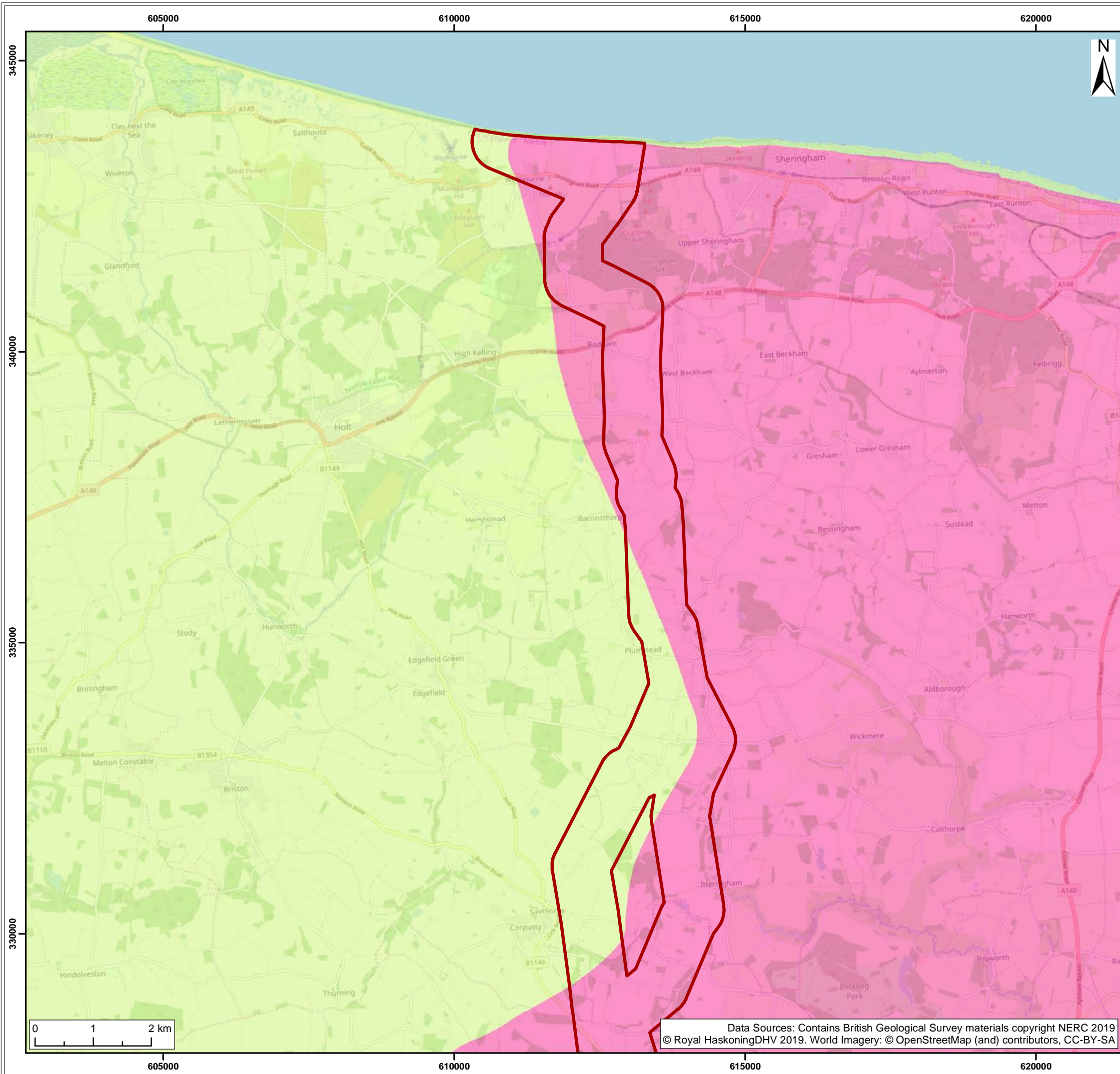

Legend:

- Onshore Scoping Area
- Bedrock Geology**
- CHALK FORMATION
- CRAG GROUP - SAND AND GRAVEL

A1	C01	02/10/2019	Approved & accepted stage complete	LB	MW	AP
SUI	REV	DATE	DESCRIPTION	DRW	CHK	APR

Title:  
**Bedrock Geology**

Figure: 3.1.1b | Drawing No: PB8164-RHD-ZZ-ON-DR-Z-0022

Co-ordinate system: British National Grid | Page Size: A3 | Scale: 1:65,000

Project: Dudgeon and Sheringham Shoal Offshore Wind Farm Extensions | Report: Scoping Report

Data Sources: Contains British Geological Survey materials copyright NERC 2019  
© Royal HaskoningDHV 2019. World Imagery: © OpenStreetMap (and) contributors, CC-BY-SA





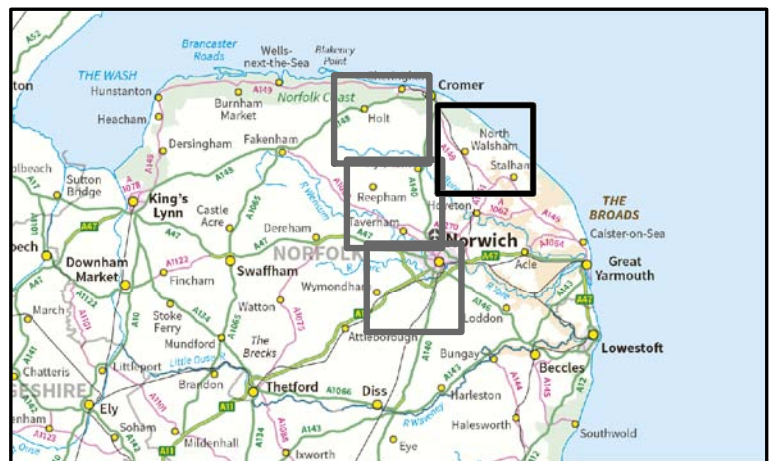
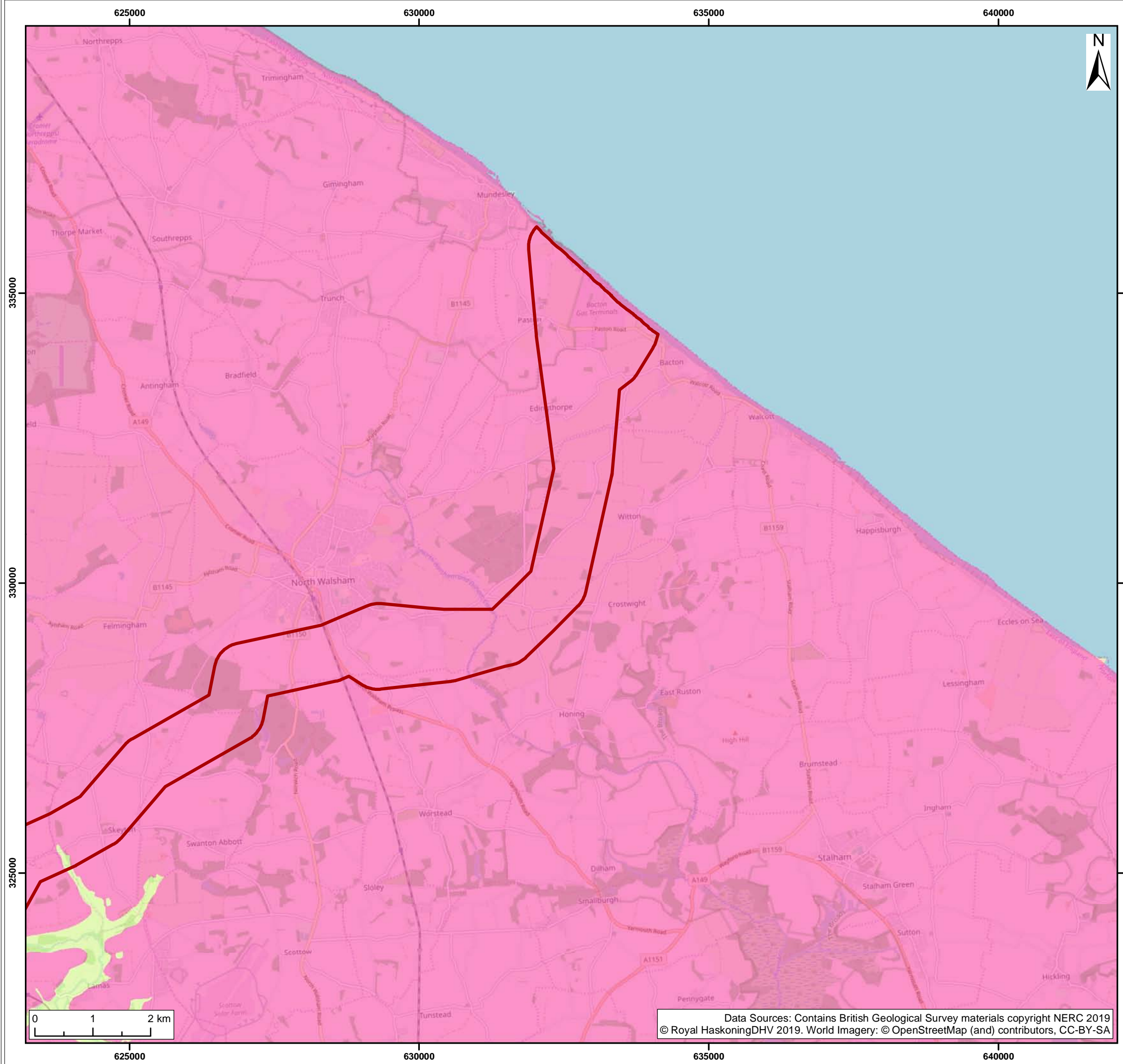

Legend:

- Onshore Scoping Area
- Bedrock Geology**
- CHALK FORMATION
- CRAG GROUP - SAND AND GRAVEL

A1	C01	02/10/2019	Approved & accepted stage complete	LB	MW	AP
SUI	REV	DATE	DESCRIPTION	DRW	CHK	APR

Title:  
**Bedrock Geology**

Figure: 3.1.1b | Drawing No: PB8164-RHD-ZZ-ON-DR-Z-0022

Co-ordinate system: British National Grid	Page Size: A3	Scale: 1:65,000
--	------------------	--------------------

Project: Dudgeon and Sheringham Shoal Offshore Wind Farm Extensions	Report:  <b>Scoping Report</b>
--	--------------------------------------



Data Sources: Contains British Geological Survey materials copyright NERC 2019  
© Royal HaskoningDHV 2019. World Imagery: © OpenStreetMap (and) contributors, CC-BY-SA



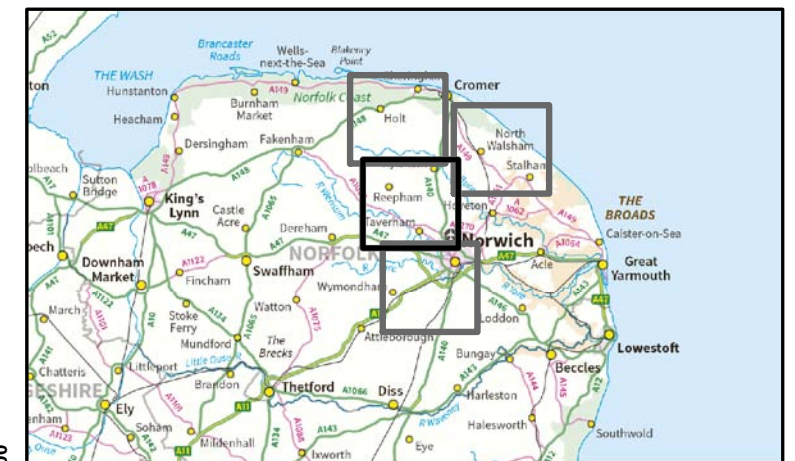
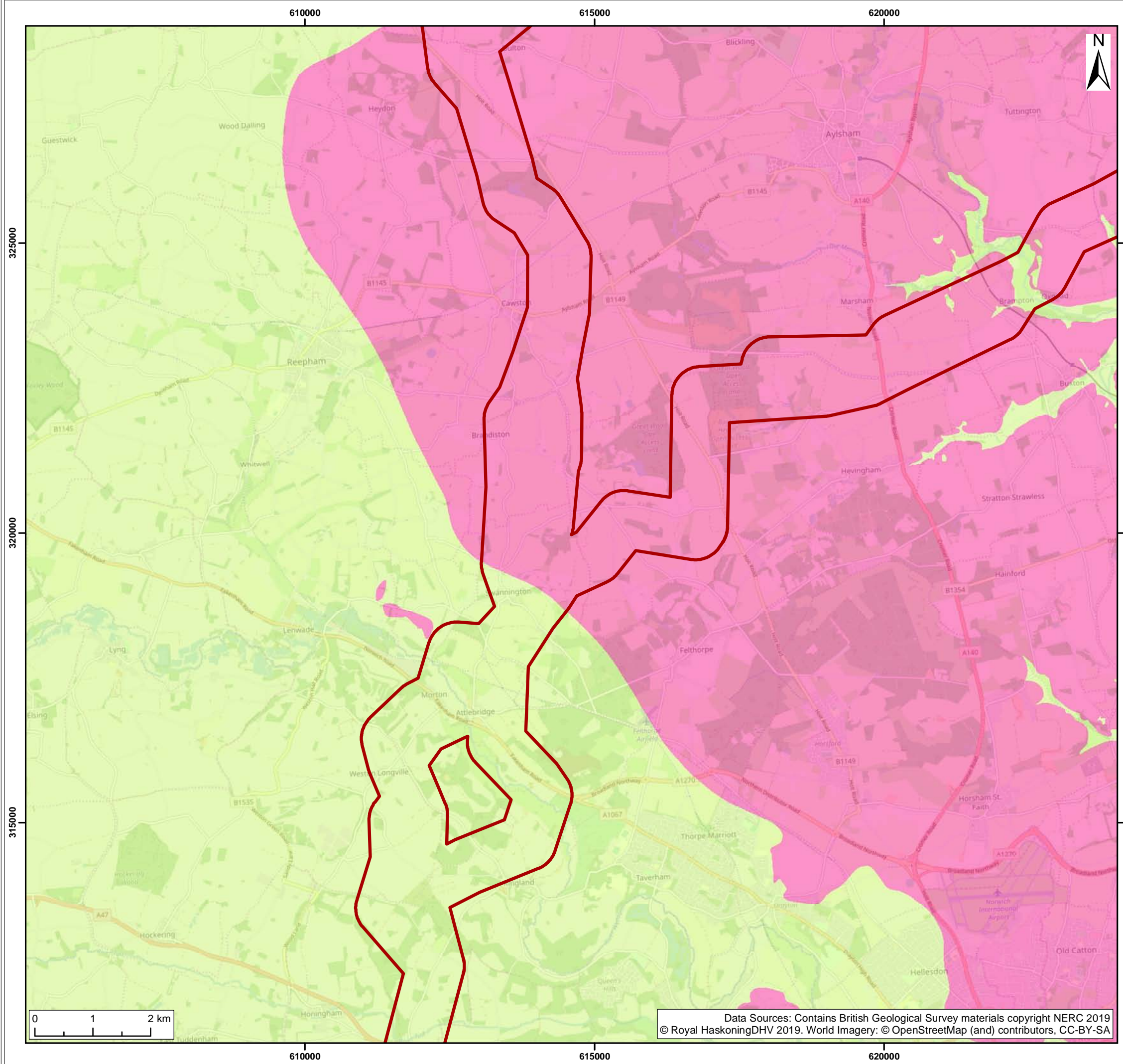

Legend:

- Onshore Scoping Area
- Bedrock Geology**
- CHALK FORMATION
- CRAG GROUP - SAND AND GRAVEL

A1	C01	02/10/2019	Approved & accepted stage complete	LB	MW	AP
SUI	REV	DATE	DESCRIPTION	DRW	CHK	APR

Title:  
**Bedrock Geology**

Figure: 3.1.1b | Drawing No: PB8164-RHD-ZZ-ON-DR-Z-0022

Co-ordinate system: British National Grid	Page Size: A3	Scale: 1:65,000
--	------------------	--------------------

Project: Dudgeon and Sheringham Shoal Offshore Wind Farm Extensions	Report: <b>Scoping Report</b>
--	----------------------------------





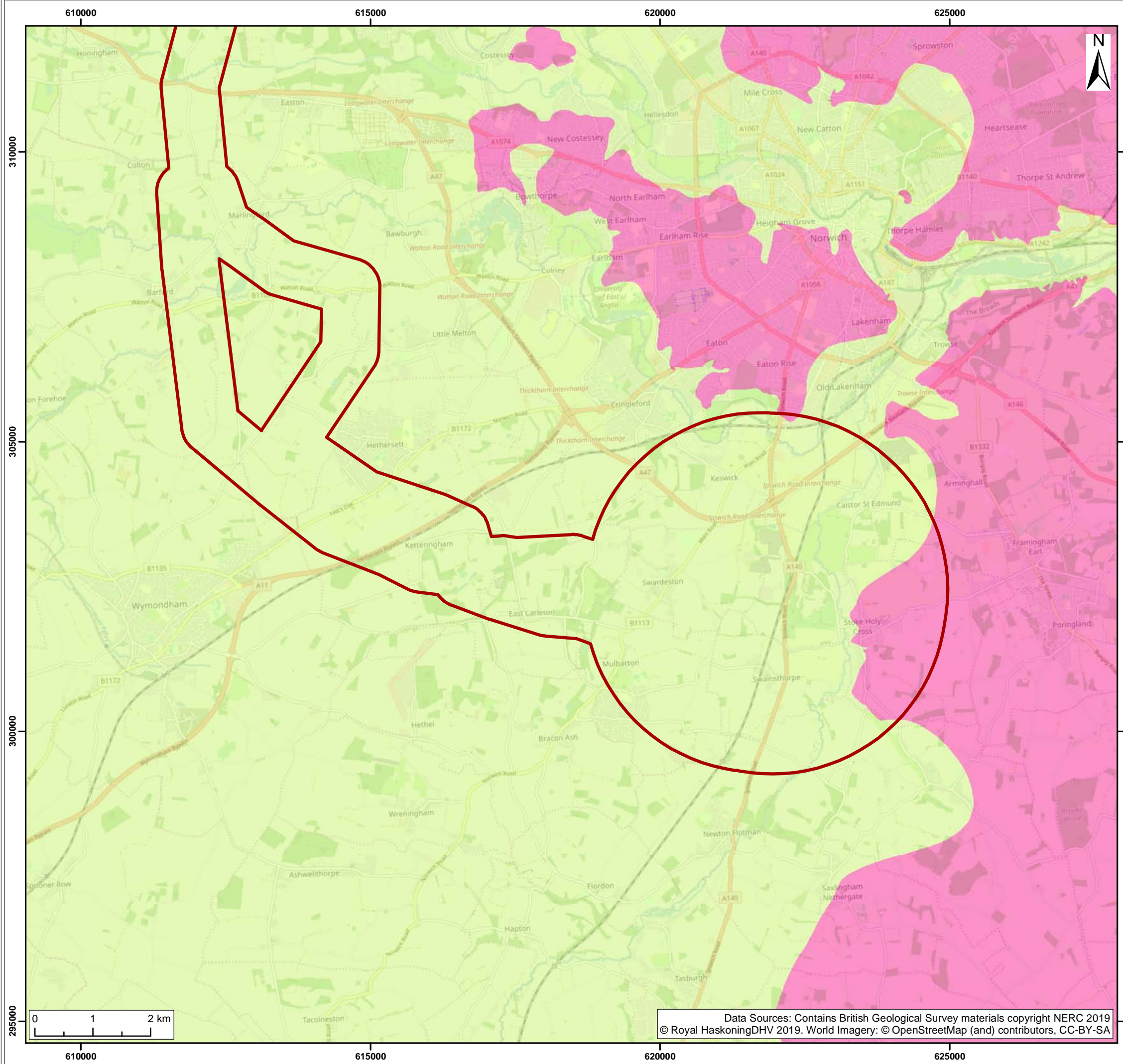

Legend:

Onshore Scoping Area

**Bedrock Geology**

CHALK FORMATION

CRAG GROUP - SAND AND GRAVEL

A1	C01	02/10/2019	Approved & accepted stage complete	LB	MW	AP
SUI	REV	DATE	DESCRIPTION	DRW	CHK	APR

Title:  
**Bedrock Geology**

Figure: 3.1.1b | Drawing No: PB8164-RHD-ZZ-ON-DR-Z-0022

Co-ordinate system: British National Grid	Page Size: A3	Scale: 1:65,000
--	------------------	--------------------

Project: Dudgeon and Sheringham Shoal Offshore Wind Farm Extensions	Report: <b>Scoping Report</b>
--	----------------------------------



Data Sources: Contains British Geological Survey materials copyright NERC 2019  
© Royal HaskoningDHV 2019. World Imagery: © OpenStreetMap (and) contributors, CC-BY-SA



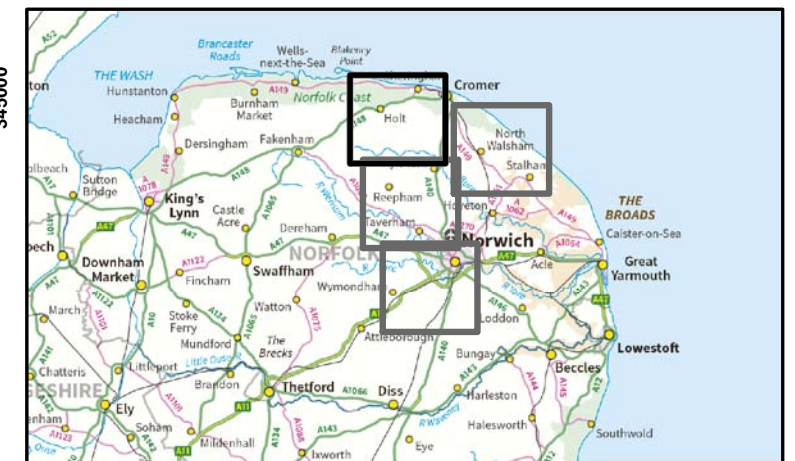
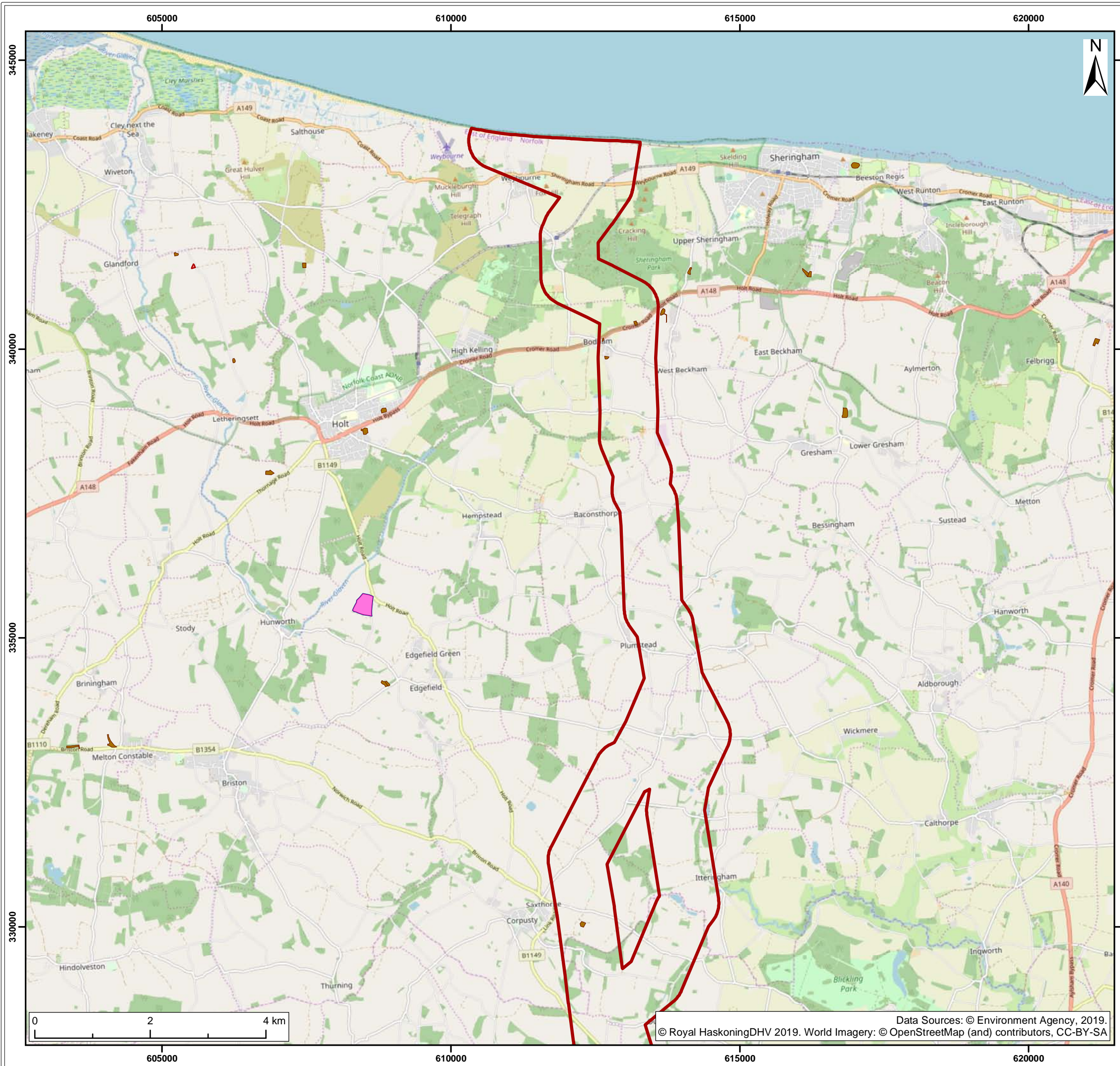

- Legend:
- Onshore Scoping Area
  - Historic Landfill Sites
  - Authorised Landfill Sites**
    - 5.2 A(1) a): Waste Landfilling
    - A4 Household, Commercial & Industrial Waste Landfill
    - A5: Landfill taking Non-Biodegradable Wastes

A1	C01	02/10/2019	Approved & accepted stage complete	LB	MW	AP
SUI	REV	DATE	DESCRIPTION	DRW	CHK	APR

Title:  
Historic and authorised landfill sites

Figure: 3.1.2      Drawing No: PB8164-RHD-ZZ-ON-DR-Z-0021

Co-ordinate system: British National Grid	Page Size: A3	Scale: 1:65,000
--	------------------	--------------------

Project: Dudgeon and Sheringham Shoal Offshore Wind Farm Extensions	Report: Scoping Report
--	---------------------------





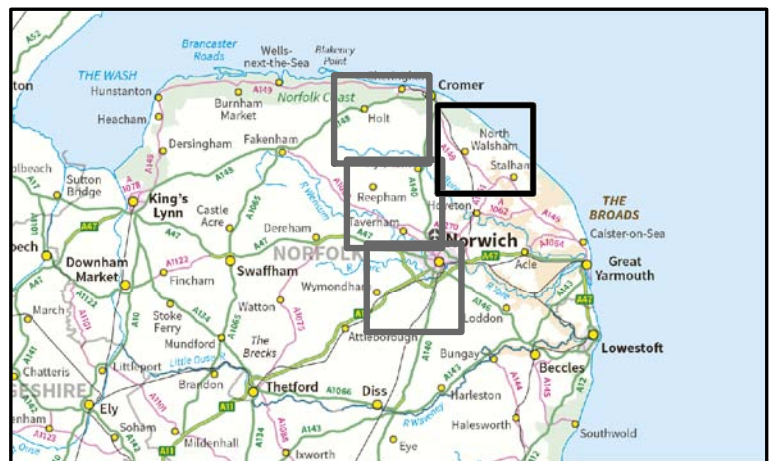
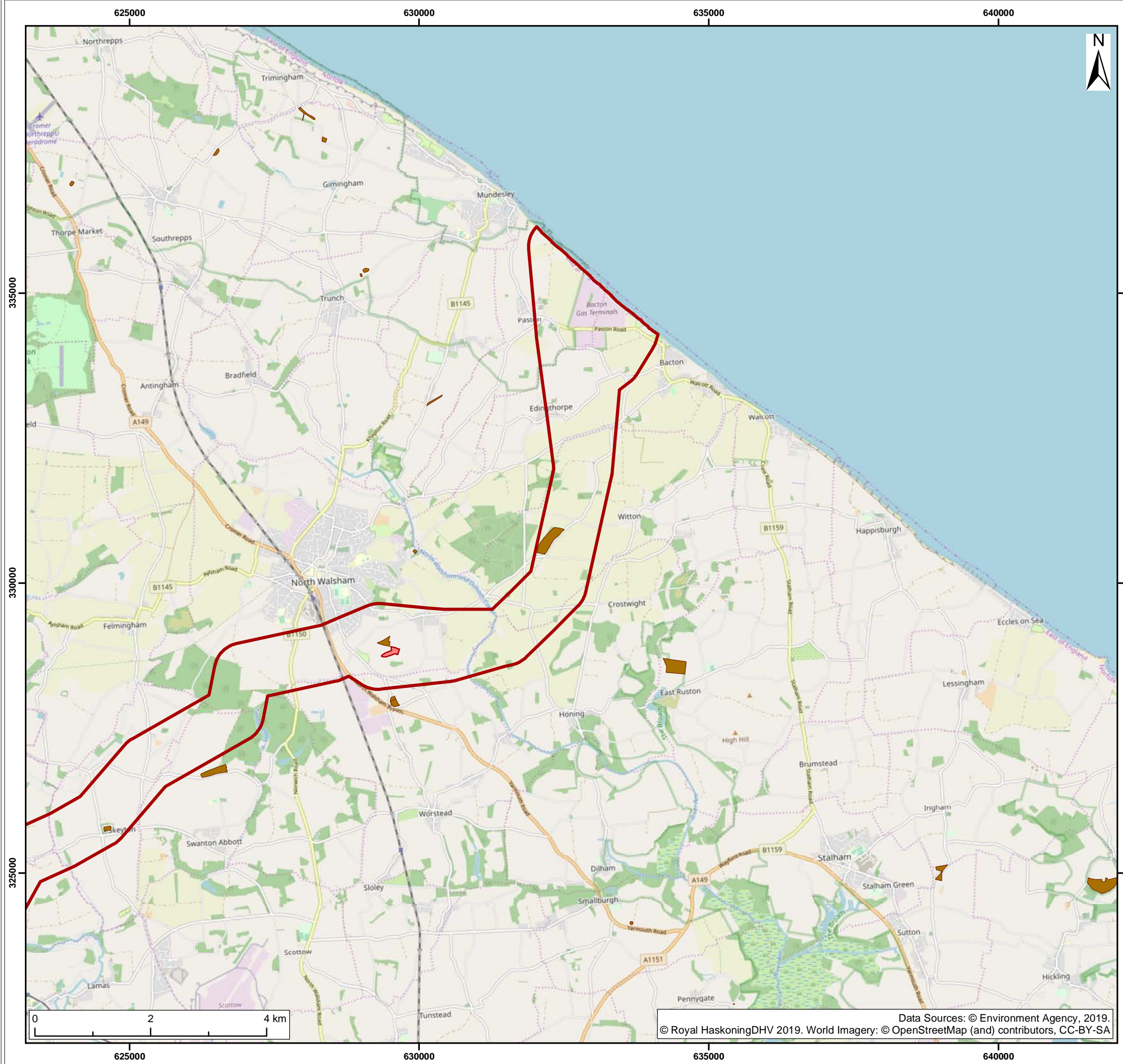

- Legend:
- Onshore Scoping Area
  - Historic Landfill Sites
  - Authorised Landfill Sites**
  - A5: Landfill taking Non-Biodegradable Wastes

A1	C01	02/10/2019	Approved & accepted stage complete	LB	MW	AP
SUI	REV	DATE	DESCRIPTION	DRW	CHK	APR

Title:  
 Historic and authorised landfill sites

Figure: 3.1.2      Drawing No: PB8164-RHD-ZZ-ON-DR-Z-0021

Co-ordinate system: British National Grid	Page Size: A3	Scale: 1:65,000
--	------------------	--------------------

Project: Dudgeon and Sheringham Shoal Offshore Wind Farm Extensions	Report:  Scoping Report
--	-------------------------------





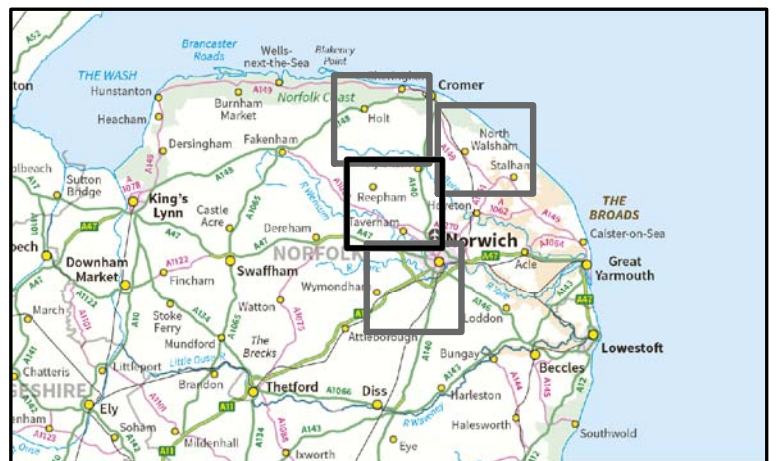
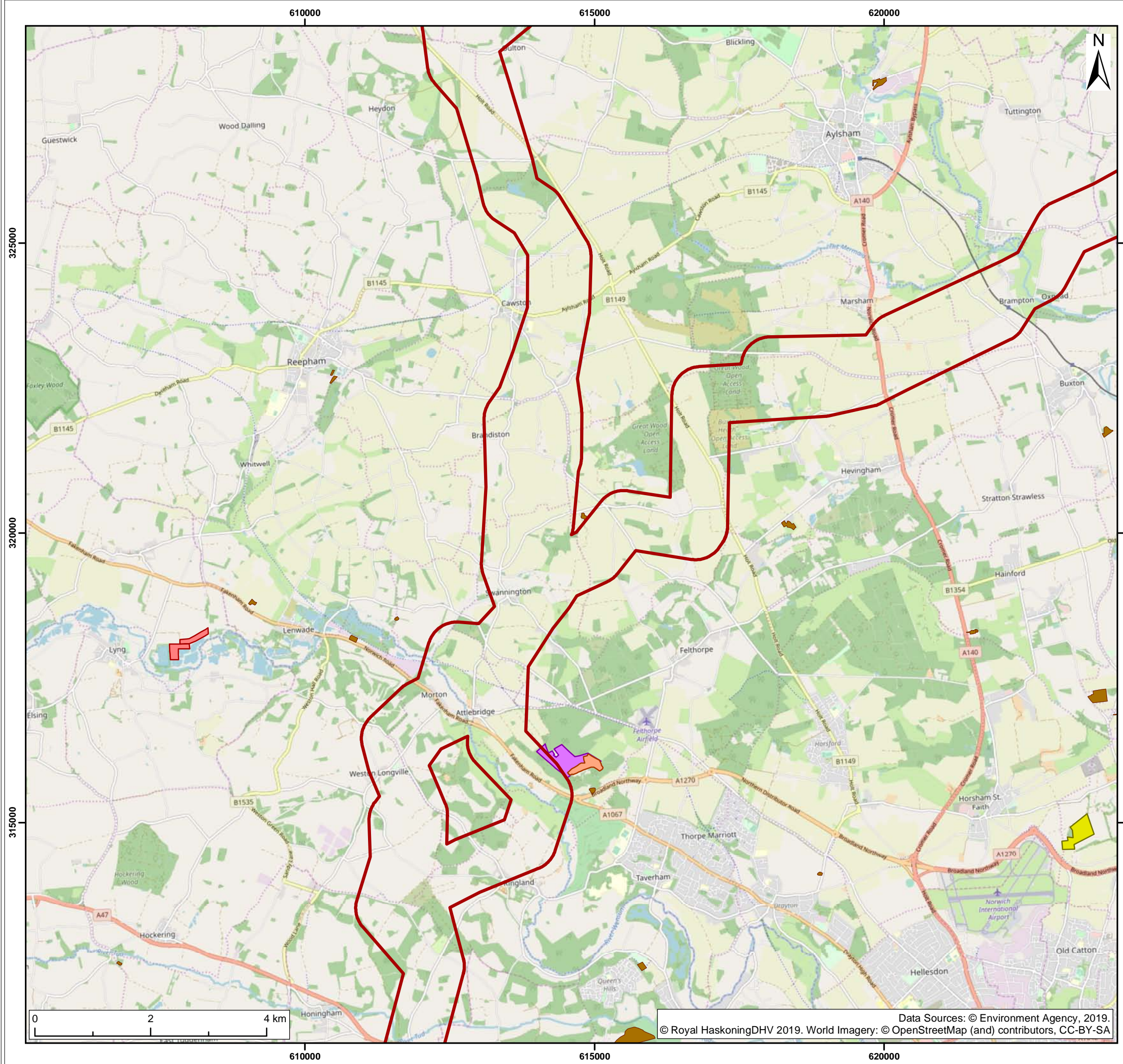

- Legend:
- Onshore Scoping Area
  - Historic Landfill Sites
  - Authorised Landfill Sites**
  - A1: Co-Disposal Landfill Site
  - A5: Landfill taking Non-Biodegradable Wastes
  - A6: Landfill taking other wastes
  - L05: Inert Landfill

A1	C01	02/10/2019	Approved & accepted stage complete	LB	MW	AP
SUI	REV	DATE	DESCRIPTION	DRW	CHK	APR

Title:  
Historic and authorised landfill sites

Figure: 3.1.2      Drawing No: PB8164-RHD-ZZ-ON-DR-Z-0021

Co-ordinate system: British National Grid	Page Size: A3	Scale: 1:65,000
--	------------------	--------------------

Project: Dudgeon and Sheringham Shoal Offshore Wind Farm Extensions	Report:  Scoping Report
--	-------------------------------





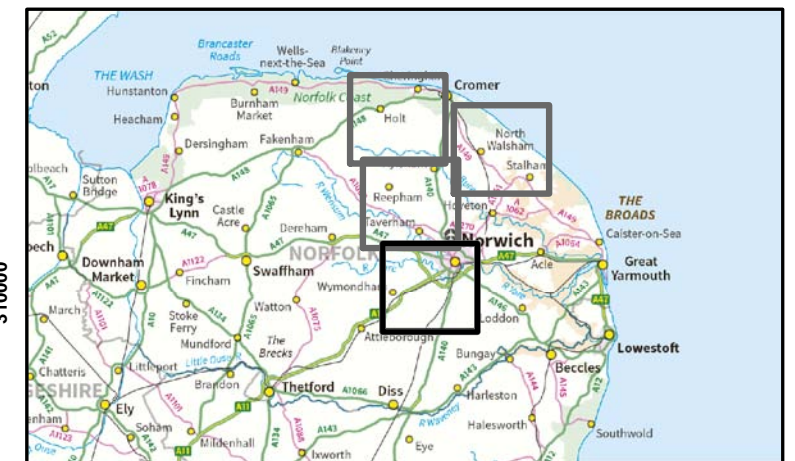
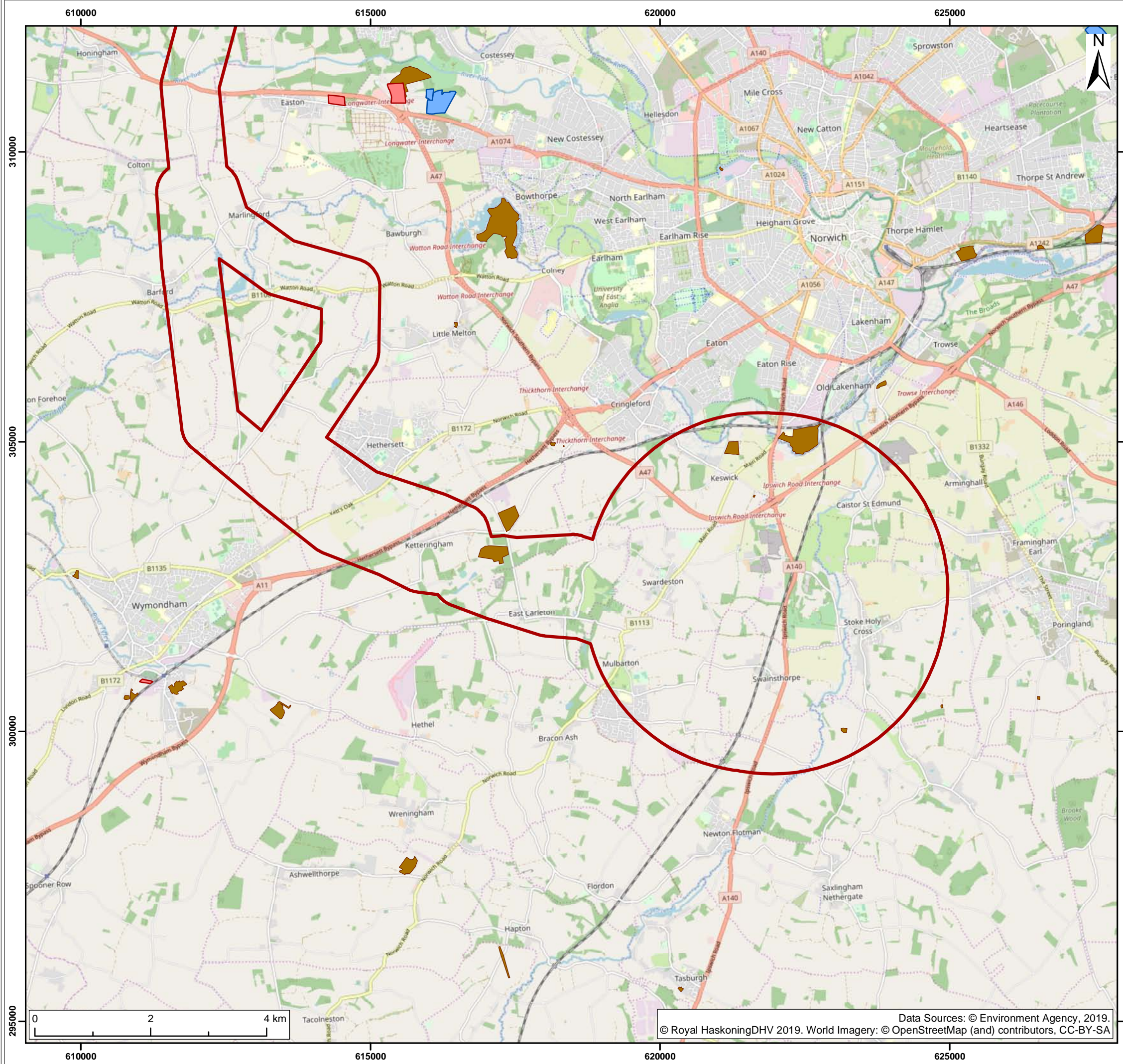

- Legend:
- Onshore Scoping Area
  - Historic Landfill Sites
  - Authorised Landfill Sites**
  - A4 Household, Commercial & Industrial Waste Landfill
  - A5: Landfill taking Non-Biodegradable Wastes

A1	C01	02/10/2019	Approved & accepted stage complete	LB	MW	AP
SUI	REV	DATE	DESCRIPTION	DRW	CHK	APR

Title:  
Historic and authorised landfill sites

Figure: 3.1.2      Drawing No: PB8164-RHD-ZZ-ON-DR-Z-0021

Co-ordinate system: British National Grid	Page Size: A3	Scale: 1:65,000
--	------------------	--------------------

Project: Dudgeon and Sheringham Shoal Offshore Wind Farm Extensions	Report: Scoping Report
--	---------------------------









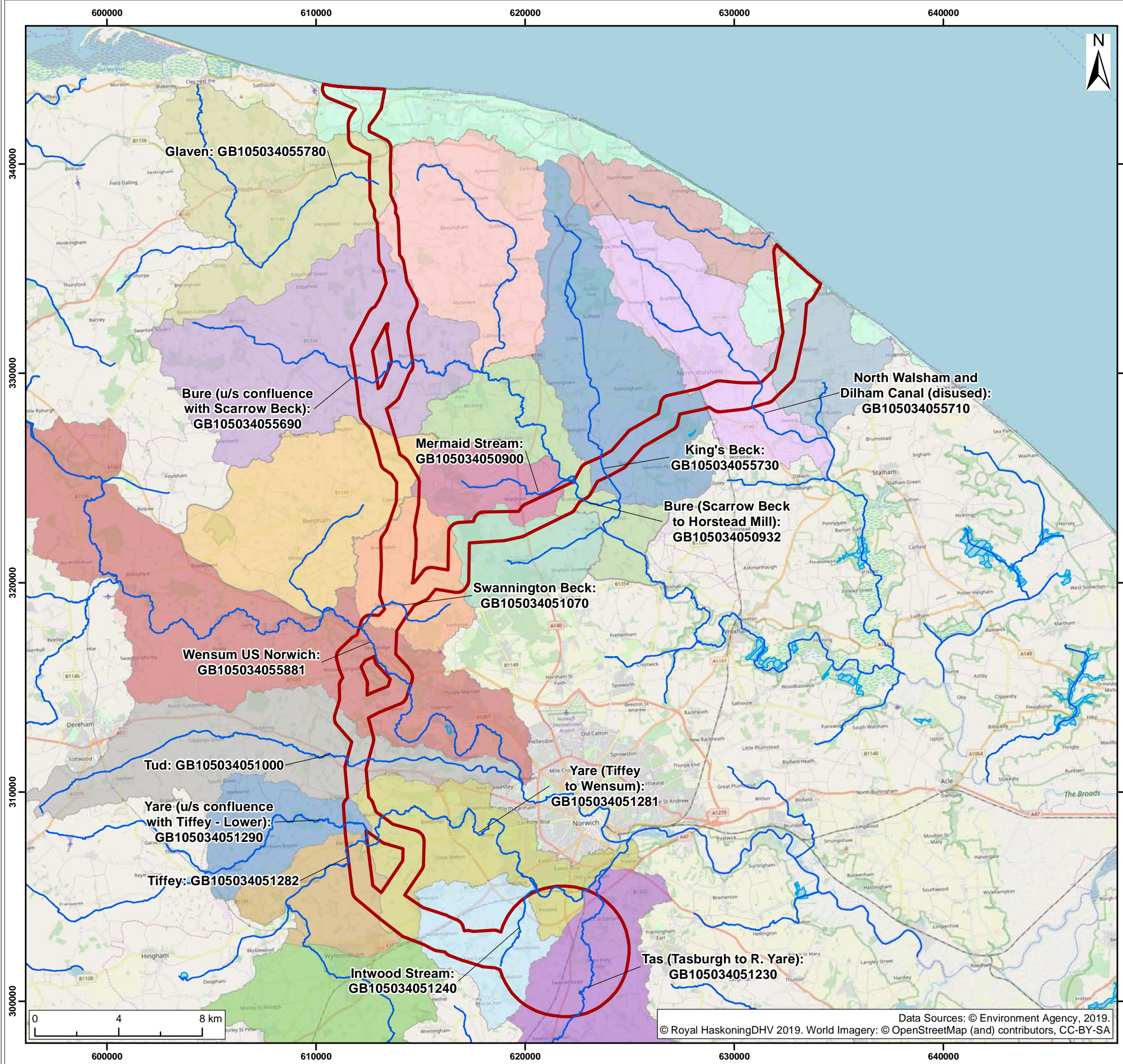

- Legend:**
- Onshore Scoping Area
  - WFD Lake Water Bodies
  - WFD River Water Body Catchment**
  - Blackwater Drain (Wensum)
  - Bure (Scarow Beck to Horstead Mill)
  - Bure (u/s confluence with Scarow Beck)
  - East Ruston Stream
  - Glaven
  - Hevingham Watercourse
  - Intwood Stream
  - King's Beck
  - Mermaid Stream
  - Mun
  - North Walsham and Dilham Canal (disused)
  - Not part of a river WB catchment
  - Scarow Beck
  - Swannington Beck
  - Tas (Tasburgh to R. Yare)
  - Tiffey
  - Tiffey (u/s Wymondham STW)
  - Tud
  - Wensum US Norwich
  - Yare (Tiffey to Wensum)
  - Yare (u/s confluence with Tiffey - Lower)
  - WFD River Water Bodies

A1	C01	02/10/2019	Approved & accepted stage complete	LB	MW	AP
SUI	REV	DATE	DESCRIPTION	DRW	CHK	APR

Title:  
WFD Water Bodies

Figure:3.2.2      Drawing No: PB8164-RHD-ZZ-ON-DR-Z-0019

Co-ordinate system: British National Grid      Page Size: A3      Scale: 1:180,000

Project: Dudgeon and Sheringham Shoal Offshore Wind Farm Extensions      Report: Scoping Report



Data Sources: © Environment Agency, 2019.  
© Royal HaskoningDHV 2019. World Imagery: © OpenStreetMap (and) contributors, CC-BY-SA





- Legend:
- Onshore Scoping Area
  - Main Rivers
  - Flood Zone 3
  - Flood Zone 2

A1	C01	02/10/2019	Approved & accepted stage complete	LB	MW	AP
SUI	REV	DATE	DESCRIPTION	DRW	CHK	APR

Title:  
**Flood Risk**

Figure: 3.2.3      Drawing No: PB8164-RHD-ZZ-ON-DR-Z-0018

Co-ordinate system: British National Grid      Page Size: A3      Scale: 1:180,000

Project:  
**Dudgeon and Sheringham Shoal Offshore Wind Farm Extensions**

Report:  
**Scoping Report**



Data Sources: © Environment Agency, 2019.  
© Royal HaskoningDHV 2019. World Imagery: © OpenStreetMap (and) contributors, CC-BY-SA



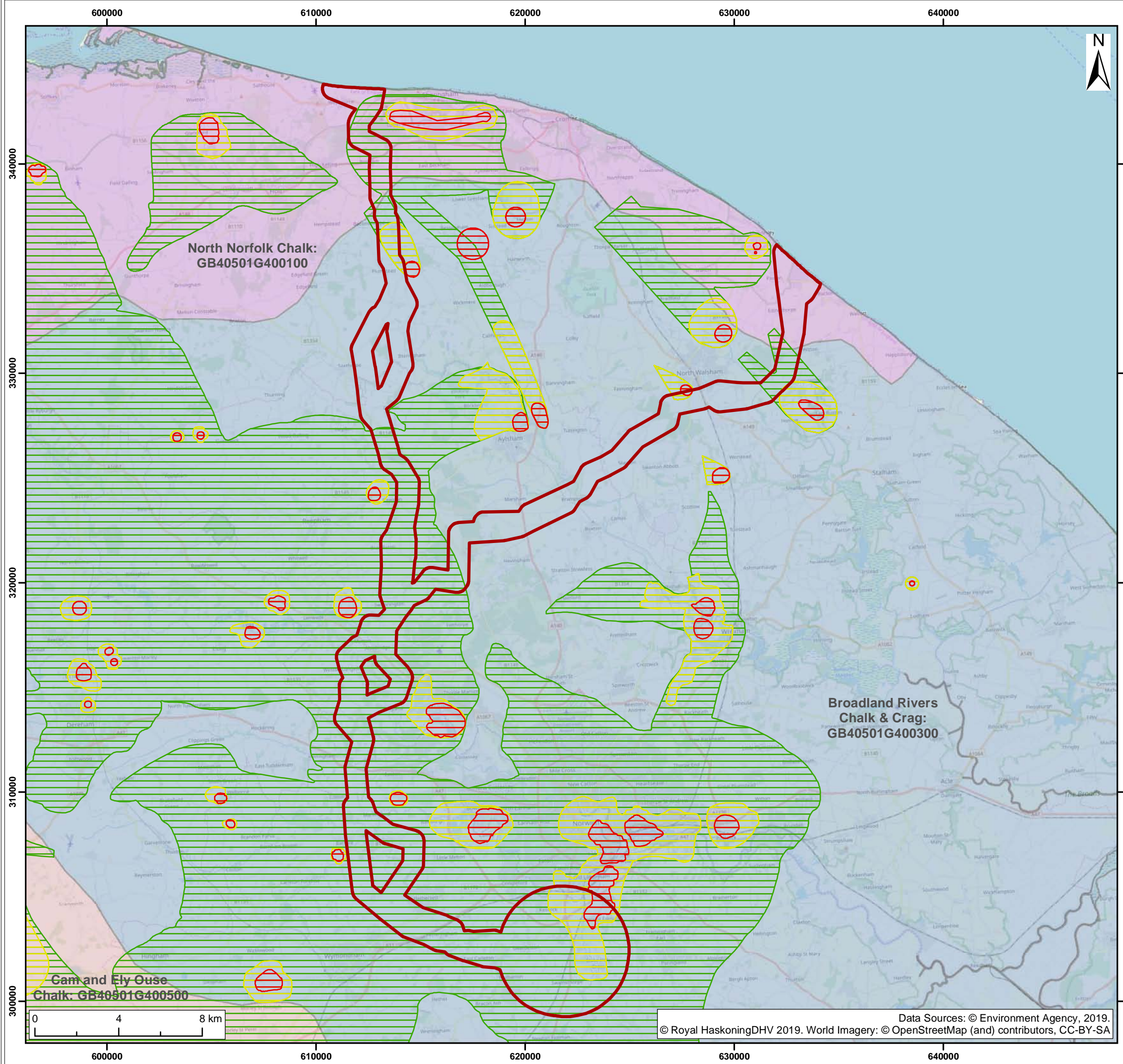

- Legend:
- Onshore Scoping Area
  - WFD Groundwater Bodies**
  - Broadland Rivers Chalk & Crag
  - Cam and Ely Ouse Chalk
  - North Norfolk Chalk
  - Source Protection Zone**
  - Zone I
  - Zone II
  - Zone III

A1	C01	02/10/2019	Approved & accepted stage complete	LB	MW	AP
SUI	REV	DATE	DESCRIPTION	DRW	CHK	APR

Title:  
**Groundwater Resources**

Figure: 3.2.4      Drawing No: PB8164-RHD-ZZ-ON-DR-Z-0016

Co-ordinate system: British National Grid      Page Size: A3      Scale: 1:180,000

Project:  
**Dudgeon and Sheringham Shoal Offshore Wind Farm Extensions**

Report:  
**Scoping Report**





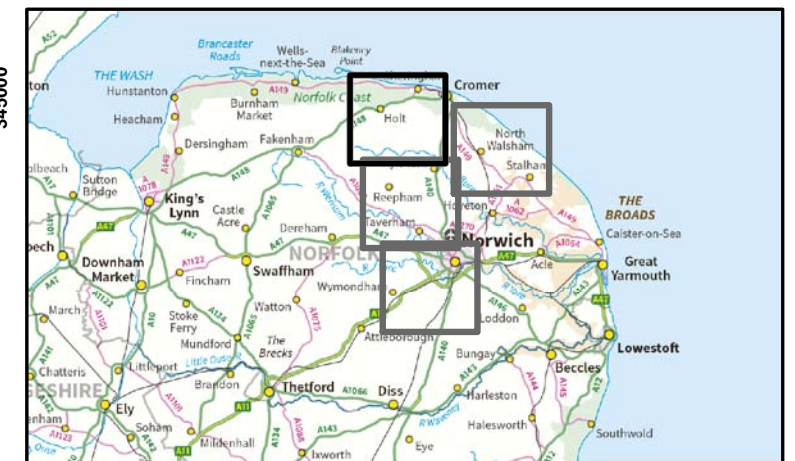
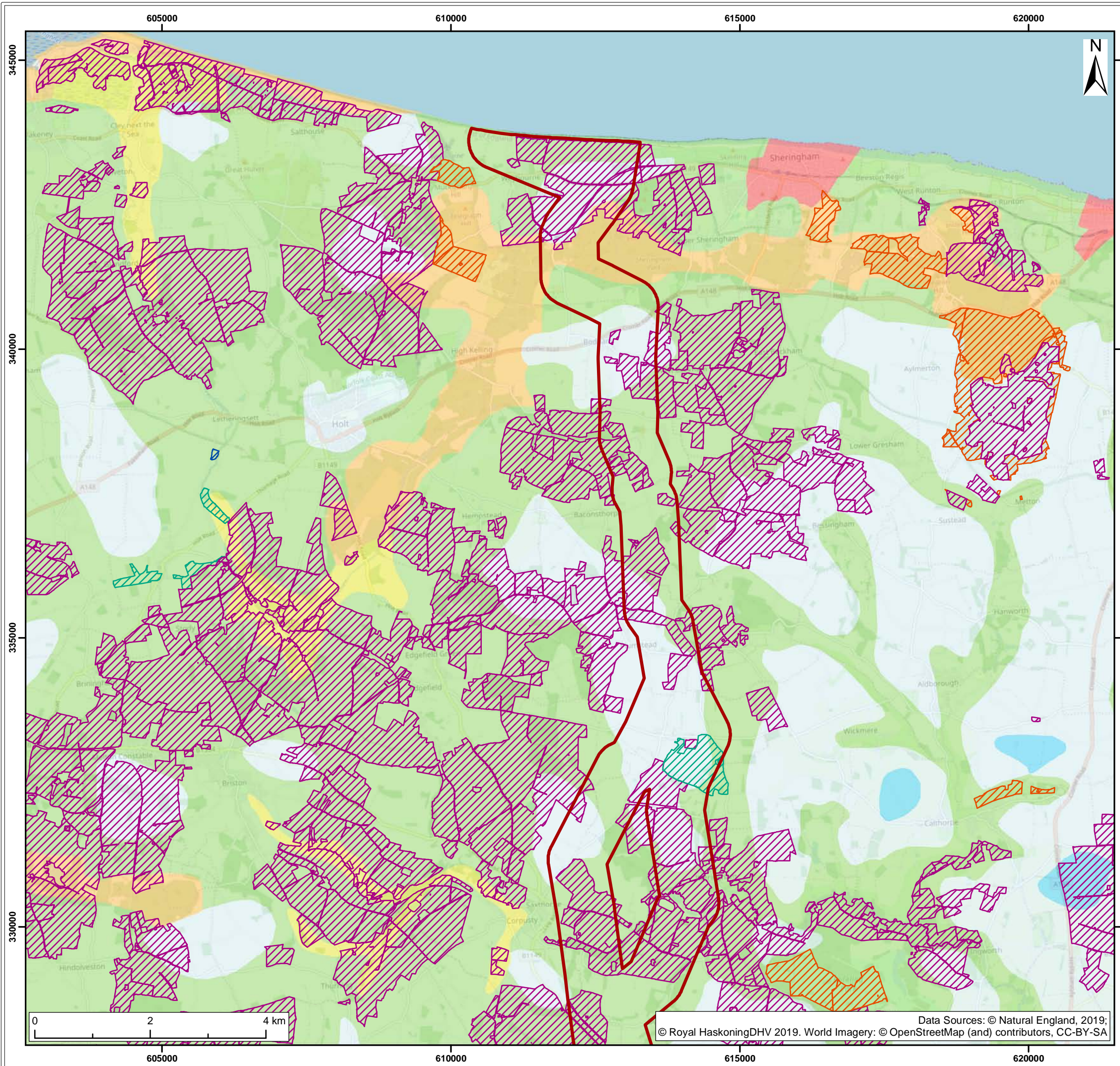

**Legend:**

- Onshore Scoping Area

**Agricultural Land Classification**

- Grade 1
- Grade 2
- Grade 3
- Grade 4
- Non Agricultural
- Urban

**Environmental Stewardship Schemes**

- Entry Level Stewardship
- Entry Level plus Higher Level Stewardship
- Higher Level Stewardship
- Organic Entry Level plus Higher Level Stewardship

A1	C01	02/10/2019	Approved & accepted stage complete	LB	MW	AP
SUI	REV	DATE	DESCRIPTION	DRW	CHK	APR

Title:  
**Main Land Use Types**

Figure:3.3.1	Drawing No: PB8164-RHD-ZZ-ON-DR-Z-0012	
Co-ordinate system: British National Grid	Page Size: A3	Scale: 1:65,000
Project: Dudgeon and Sheringham Shoal Offshore Wind Farm Extensions	Report:  <b>Scoping Report</b>	

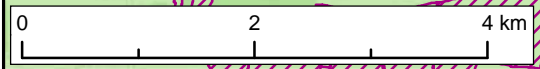

Data Sources: © Natural England, 2019;  
© Royal HaskoningDHV 2019. World Imagery: © OpenStreetMap (and) contributors, CC-BY-SA





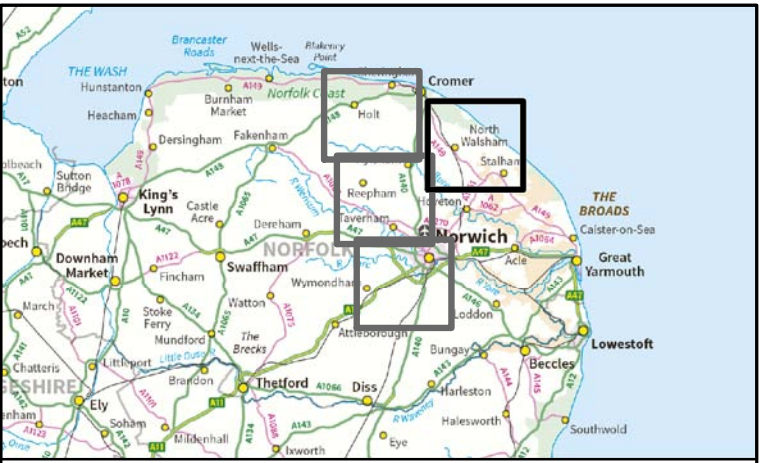
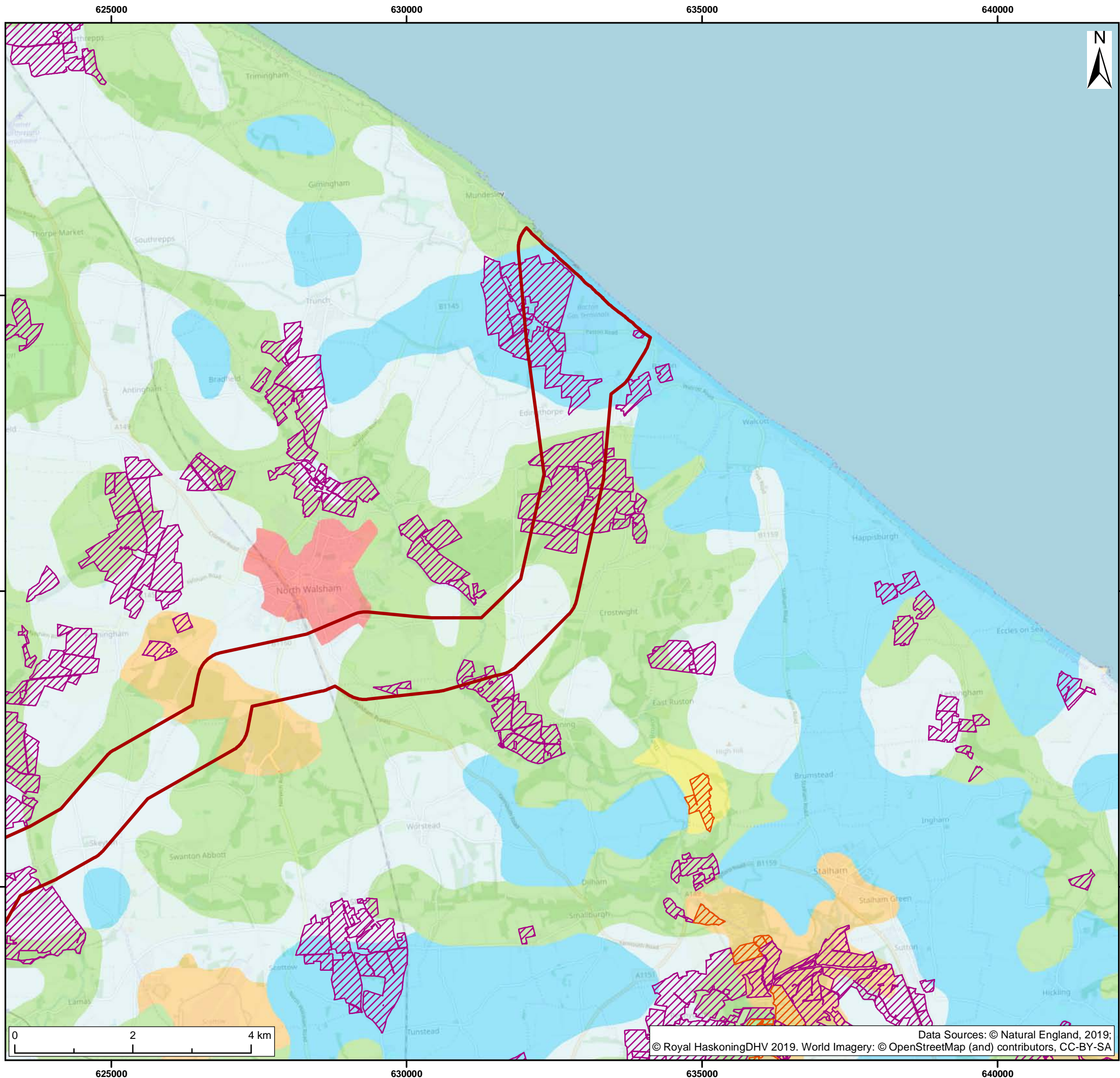

Legend:

- Onshore Scoping Area

**Agricultural Land Classification**

- Grade 1
- Grade 2
- Grade 3
- Grade 4
- Non Agricultural
- Urban

**Environmental Stewardship Schemes**

- Entry Level plus Higher Level Stewardship
- Higher Level Stewardship

A1	C01	02/10/2019	Approved & accepted stage complete	LB	MW	AP
SUI	REV	DATE	DESCRIPTION	DRW	CHK	APR

Title:  
Main Land Use Types

Figure:3.3.1      Drawing No: PB8164-RHD-ZZ-ON-DR-Z-0012

Co-ordinate system: British National Grid	Page Size: A3	Scale: 1:65,000
--	------------------	--------------------

Project: Dudgeon and Sheringham Shoal Offshore Wind Farm Extensions	Report: Scoping Report
--	---------------------------



Data Sources: © Natural England, 2019;  
© Royal HaskoningDHV 2019. World Imagery: © OpenStreetMap (and) contributors, CC-BY-SA



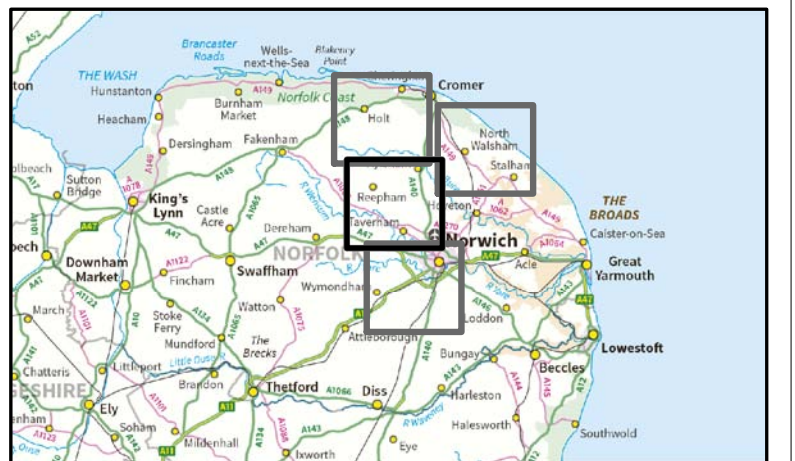
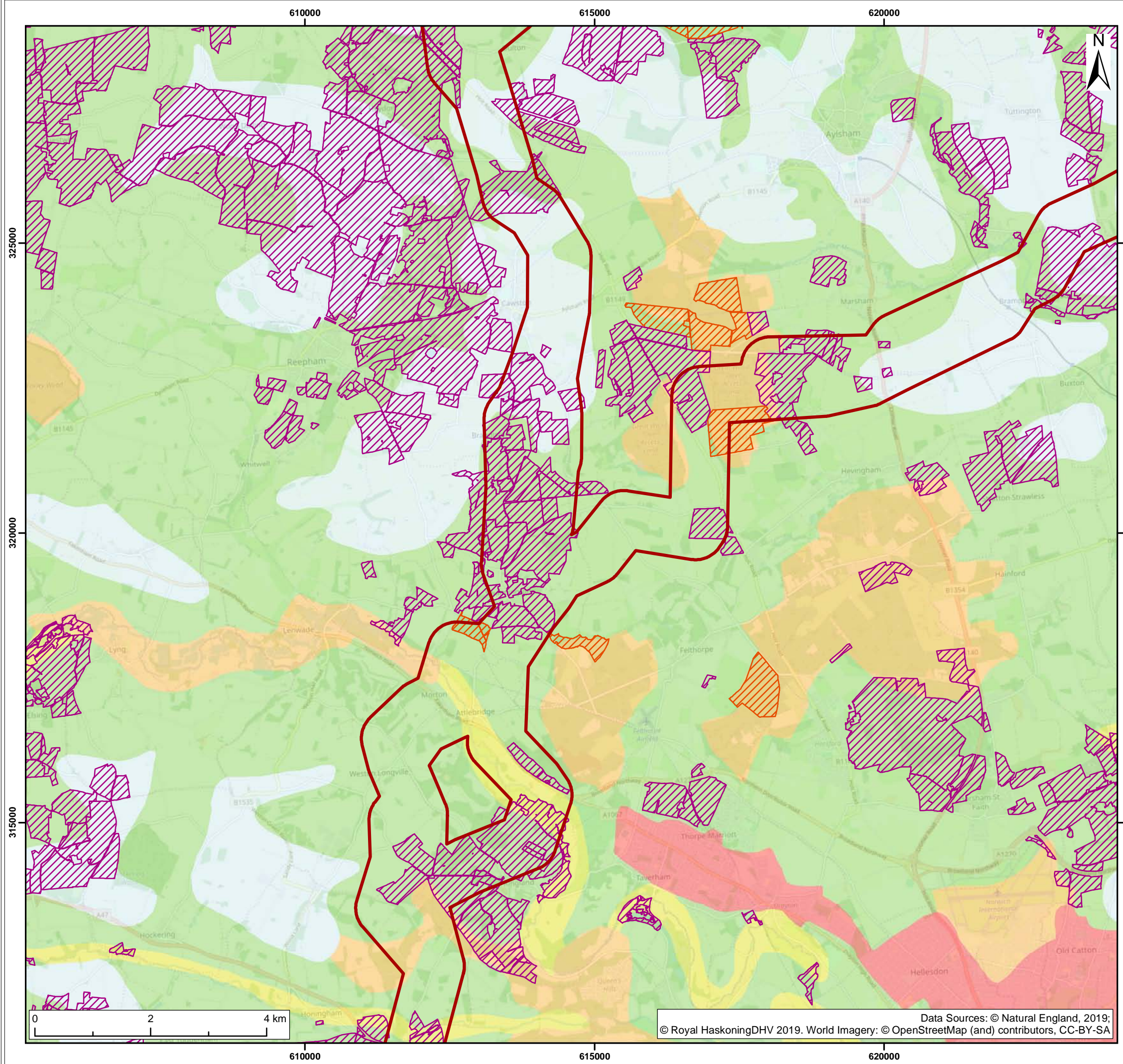

- Legend:
- Onshore Scoping Area
  - Agricultural Land Classification**
  - Grade 2
  - Grade 3
  - Grade 4
  - Non Agricultural
  - Urban
  - Environmental Stewardship Schemes**
  - Entry Level plus Higher Level Stewardship
  - Higher Level Stewardship

A1	C01	02/10/2019	Approved & accepted stage complete	LB	MW	AP
SUI	REV	DATE	DESCRIPTION	DRW	CHK	APR

Title:  
Main Land Use Types

Figure:3.3.1 Drawing No: PB8164-RHD-ZZ-ON-DR-Z-0012

Co-ordinate system: British National Grid	Page Size: A3	Scale: 1:65,000
--	------------------	--------------------

Project: Dudgeon and Sheringham Shoal Offshore Wind Farm Extensions	Report: Scoping Report
--	---------------------------



Data Sources: © Natural England, 2019;  
© Royal HaskoningDHV 2019. World Imagery: © OpenStreetMap (and) contributors, CC-BY-SA



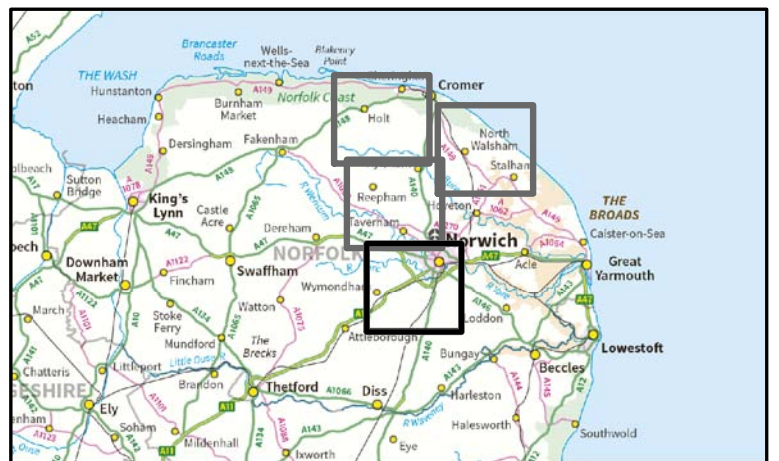
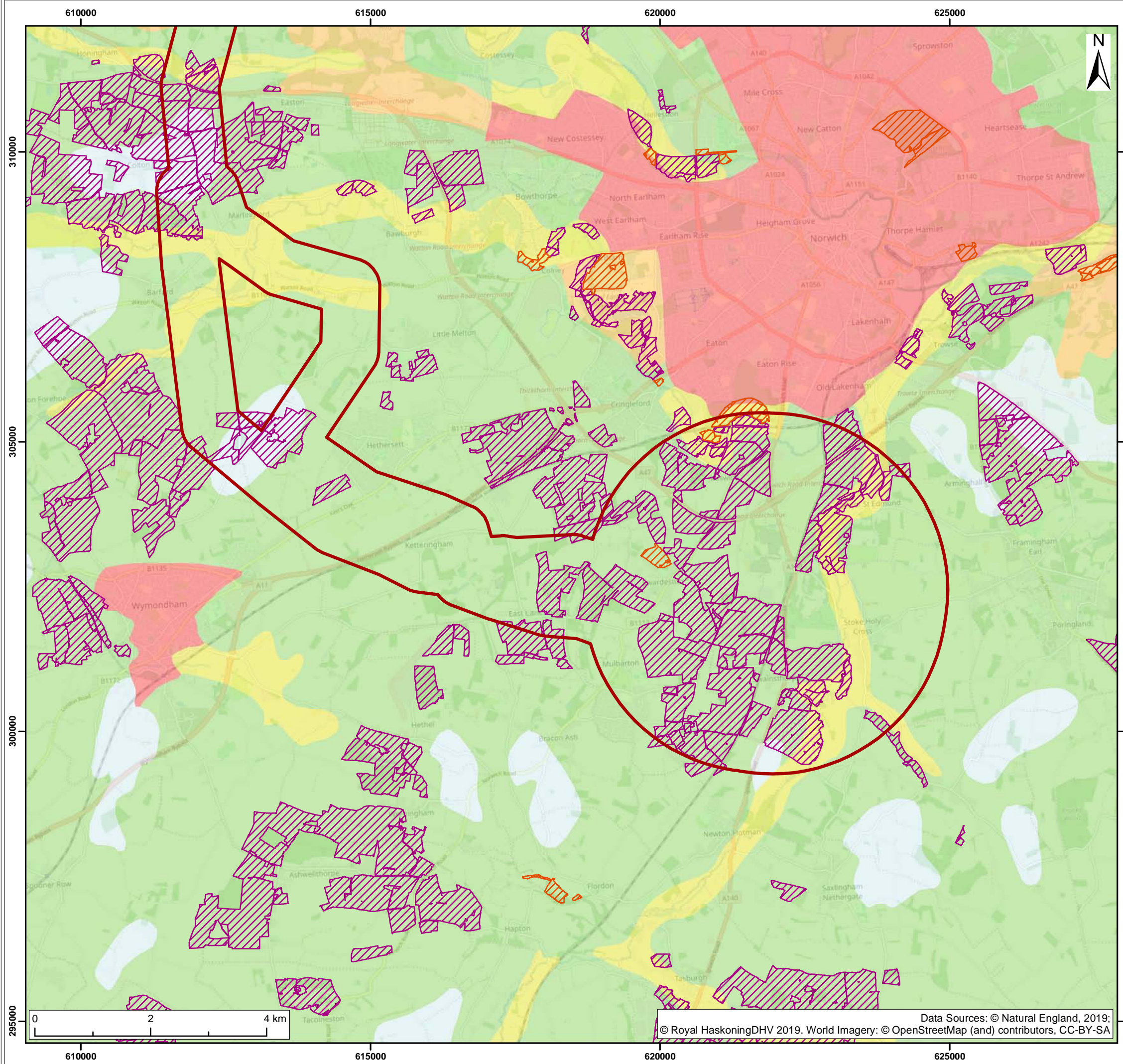

Legend:

- Onshore Scoping Area

**Agricultural Land Classification**

- Grade 2
- Grade 3
- Grade 4
- Non Agricultural
- Urban

**Environmental Stewardship Schemes**

- Entry Level plus Higher Level Stewardship
- Higher Level Stewardship

A1	C01	02/10/2019	Approved & accepted stage complete	LB	MW	AP
SUI	REV	DATE	DESCRIPTION	DRW	CHK	APR

Title:  
Main Land Use Types

Figure:3.3.1      Drawing No: PB8164-RHD-ZZ-ON-DR-Z-0012

Co-ordinate system: British National Grid      Page Size: A3      Scale: 1:65,000

Project: Dudgeon and Sheringham Shoal Offshore Wind Farm Extensions      Report: Scoping Report





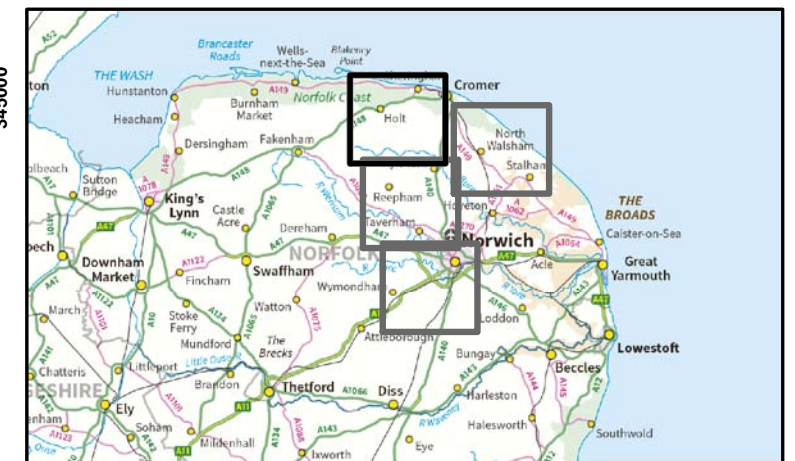
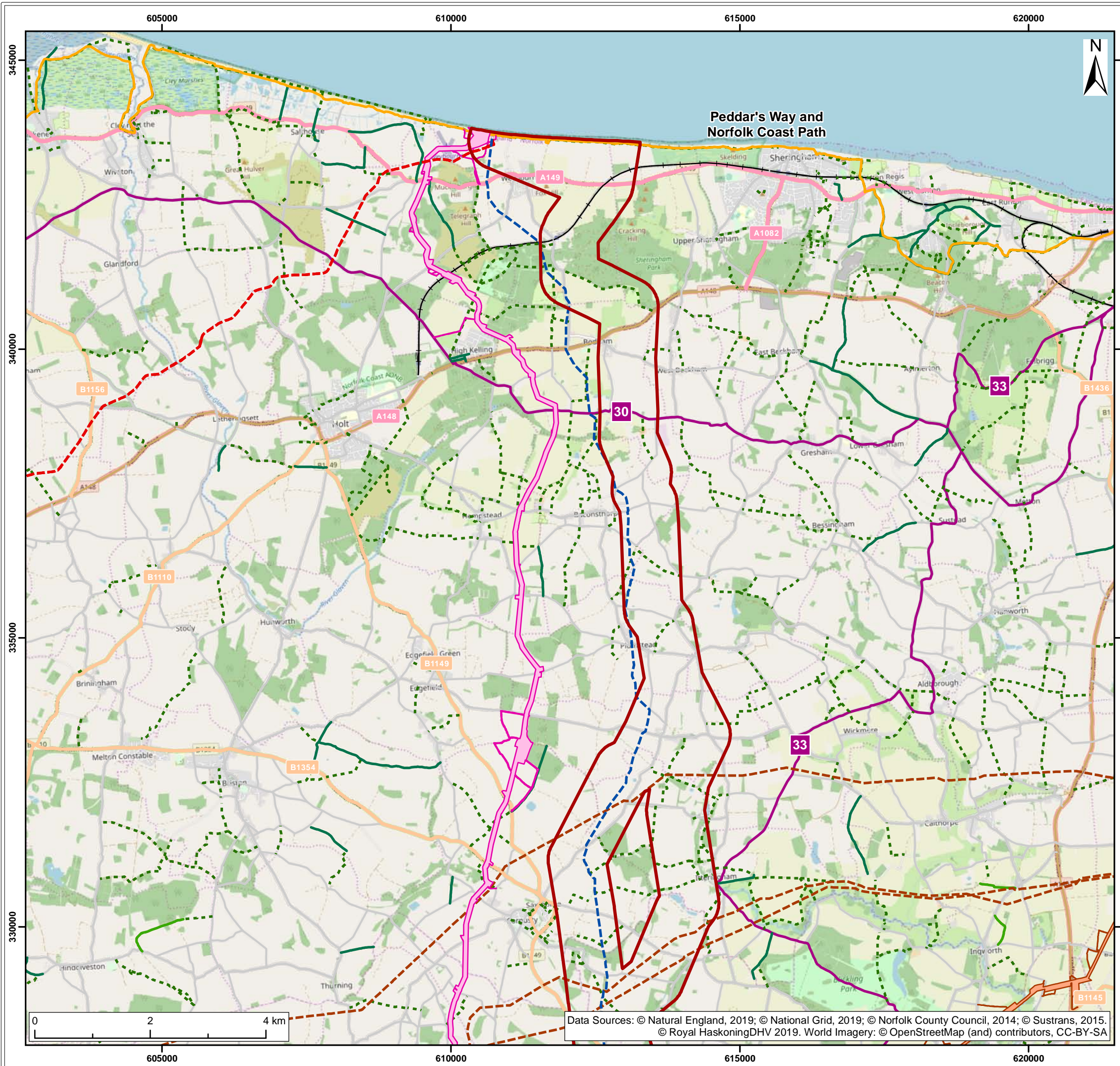

- Legend:**
- Onshore Scoping Area
  - Sheringham Shoal Underground Cable
  - Dudgeon Underground Cable
  - Norfolk Vanguard/Norfolk Boreas onshore red line boundary
  - Hornsea Project Three onshore red line boundary
  - High Pressure Gas Pipe location
  - Railway line
  - A Road
  - B Road
  - Minor Road
  - Primary Road
  - Regional Cycle Route
- Public Rights of Way**
- Footpath
  - Bridleway
  - Restricted byway
  - National Trails

A1	C01	02/10/2019	Approved & accepted stage complete	LB	MW	AP
SUI	REV	DATE	DESCRIPTION	DRW	CHK	APR

Title:  
 PRoWs Urban Areas, Roads and Utilities

Figure:3.3.2      Drawing No: PB8164-RHD-ZZ-ON-DR-Z-0013

Co-ordinate system: British National Grid      Page Size: A3      Scale: 1:65,000

Project: Dudgeon and Sheringham Shoal Offshore Wind Farm Extensions      Report: Scoping Report



Data Sources: © Natural England, 2019; © National Grid, 2019; © Norfolk County Council, 2014; © Sustrans, 2015. © Royal HaskoningDHV 2019. World Imagery: © OpenStreetMap (and) contributors, CC-BY-SA

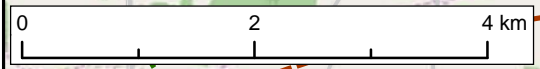



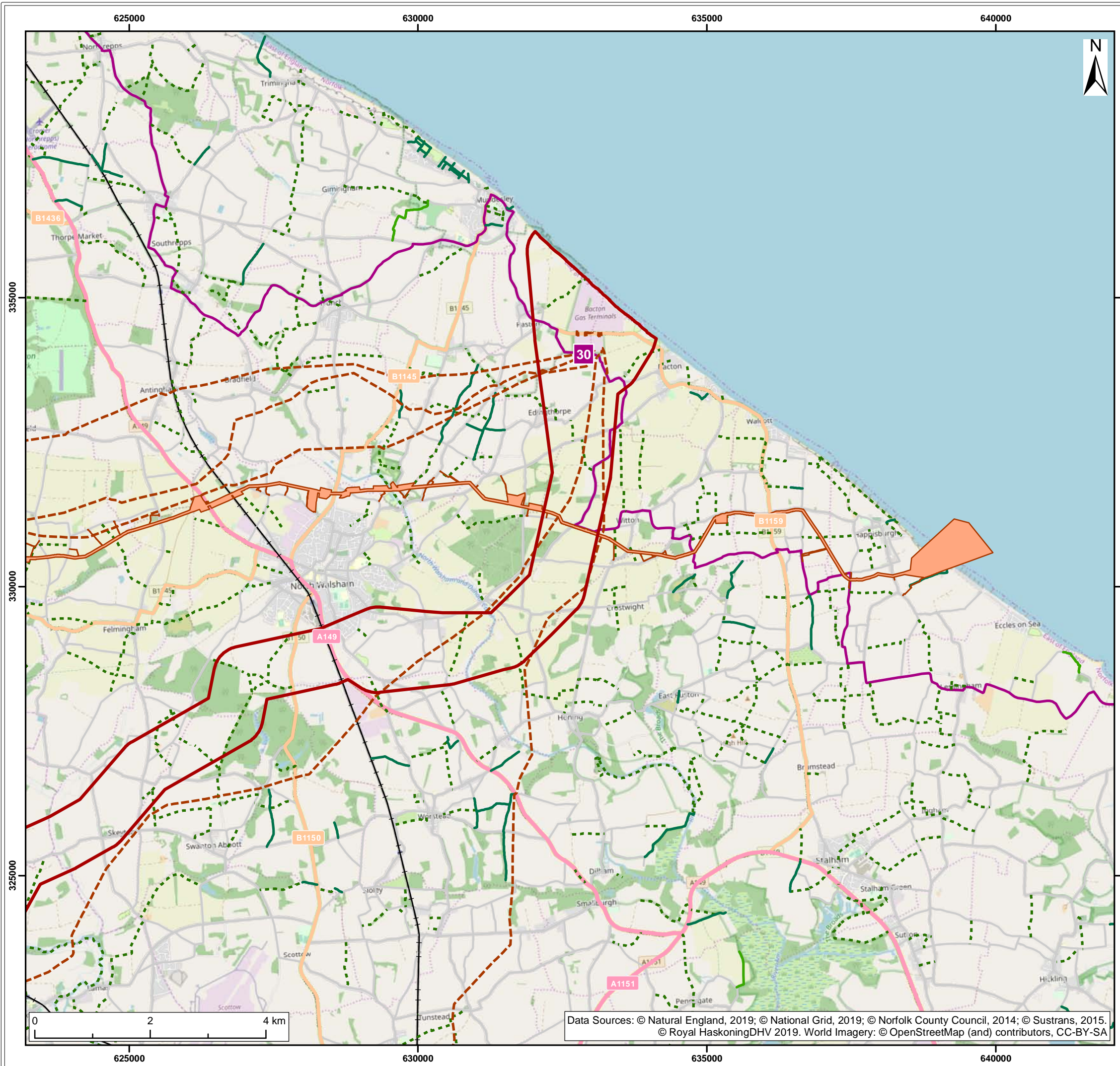

- Legend:
- Onshore Scoping Area
  - Norfolk Vanguard/Norfolk Boreas onshore red line boundary
  - High Pressure Gas Pipe location
  - Railway line
  - A Road
  - B Road
  - Minor Road
  - Regional Cycle Route
- Public Rights of Way**
- Footpath
  - Bridleway
  - Restricted byway

A1	C01	02/10/2019	Approved & accepted stage complete	LB	MW	AP
SUI	REV	DATE	DESCRIPTION	DRW	CHK	APR

Title:  
PRoWs Urban Areas, Roads and Utilities

Figure:3.3.2 Drawing No: PB8164-RHD-ZZ-ON-DR-Z-0013

Co-ordinate system: British National Grid	Page Size: A3	Scale: 1:65,000
--	------------------	--------------------

Project: Dudgeon and Sheringham Shoal Offshore Wind Farm Extensions	Report: Scoping Report
--	---------------------------

Data Sources: © Natural England, 2019; © National Grid, 2019; © Norfolk County Council, 2014; © Sustrans, 2015; © Royal HaskoningDHV 2019. World Imagery: © OpenStreetMap (and) contributors, CC-BY-SA





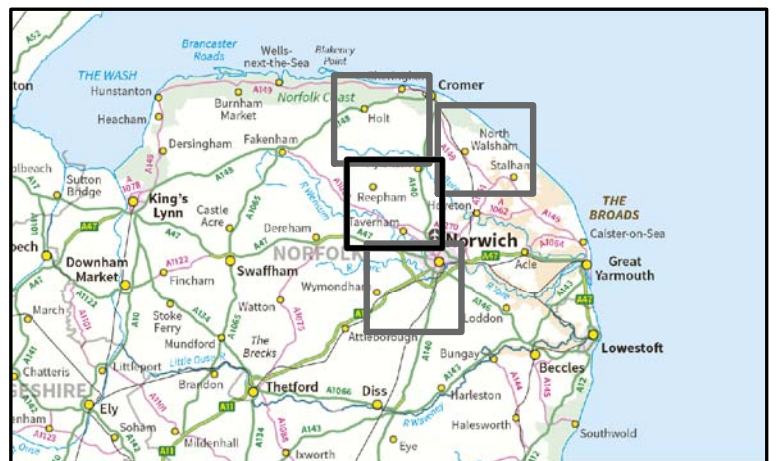
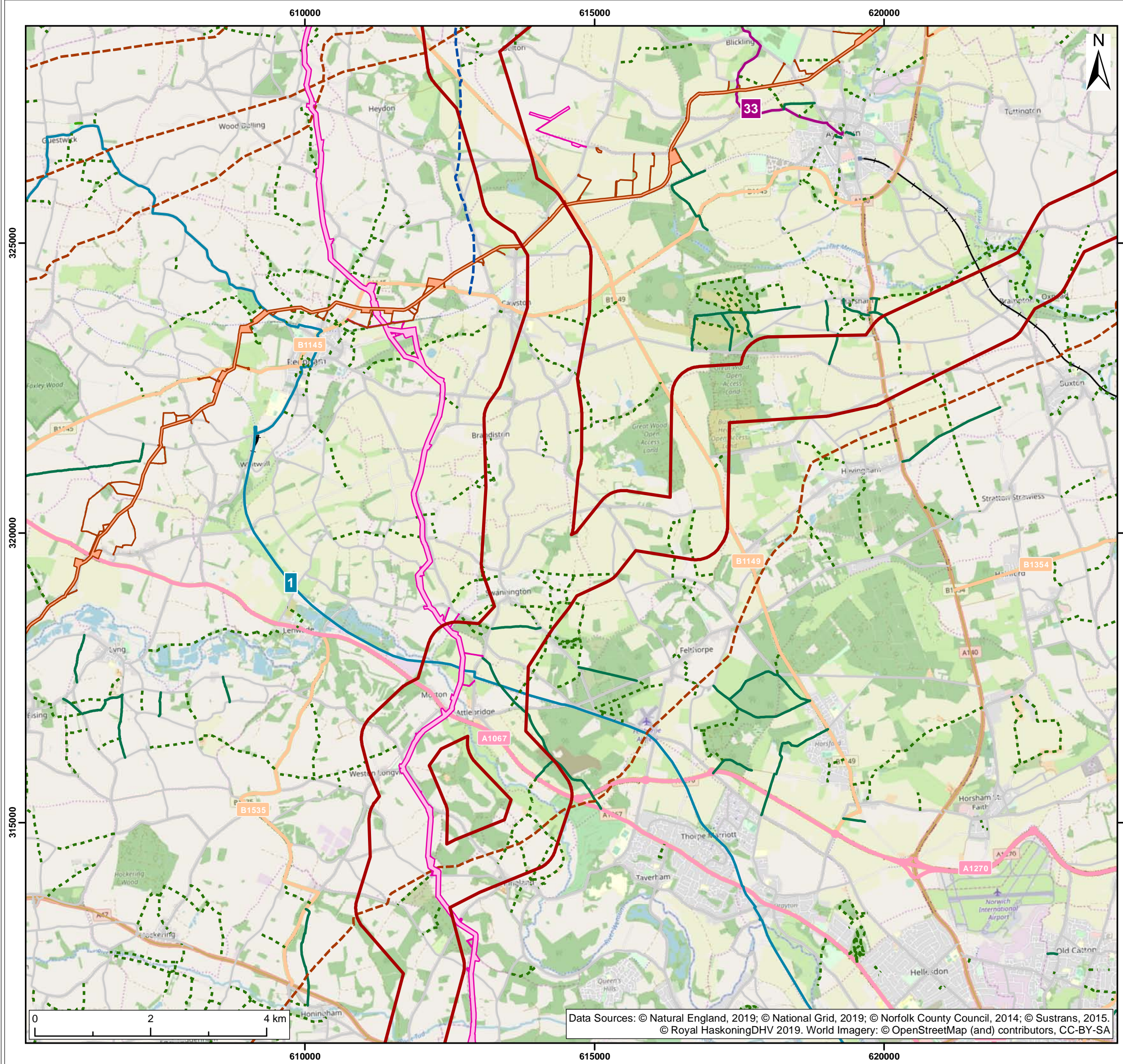

- Legend:
- Onshore Scoping Area
  - Sheringham Shoal Underground Cable
  - Norfolk Vanguard/Norfolk Boreas onshore red line boundary
  - Hornsea Project Three onshore red line boundary
  - High Pressure Gas Pipe location
  - Railway line
  - A Road
  - B Road
  - Minor Road
  - Primary Road
  - National Cycle Route
  - Regional Cycle Route
- Public Rights of Way**
- Footpath
  - Bridleway
  - Restricted byway

A1	C01	02/10/2019	Approved & accepted stage complete	LB	MW	AP
SUI	REV	DATE	DESCRIPTION	DRW	CHK	APR

Title:  
 PRoWs Urban Areas, Roads and Utilities

Figure:3.3.2 Drawing No: PB8164-RHD-ZZ-ON-DR-Z-0013

Co-ordinate system: British National Grid Page Size: A3 Scale: 1:65,000

Project: Dudgeon and Sheringham Shoal Offshore Wind Farm Extensions Report: Scoping Report

Data Sources: © Natural England, 2019; © National Grid, 2019; © Norfolk County Council, 2014; © Sustrans, 2015. © Royal HaskoningDHV 2019. World Imagery: © OpenStreetMap (and) contributors, CC-BY-SA





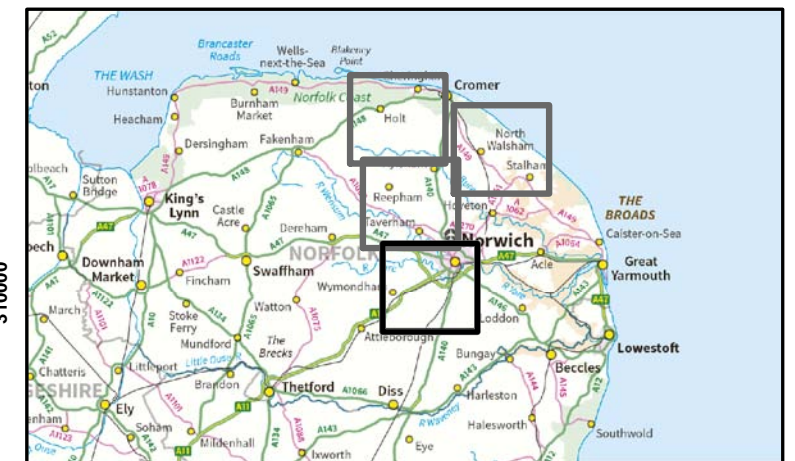
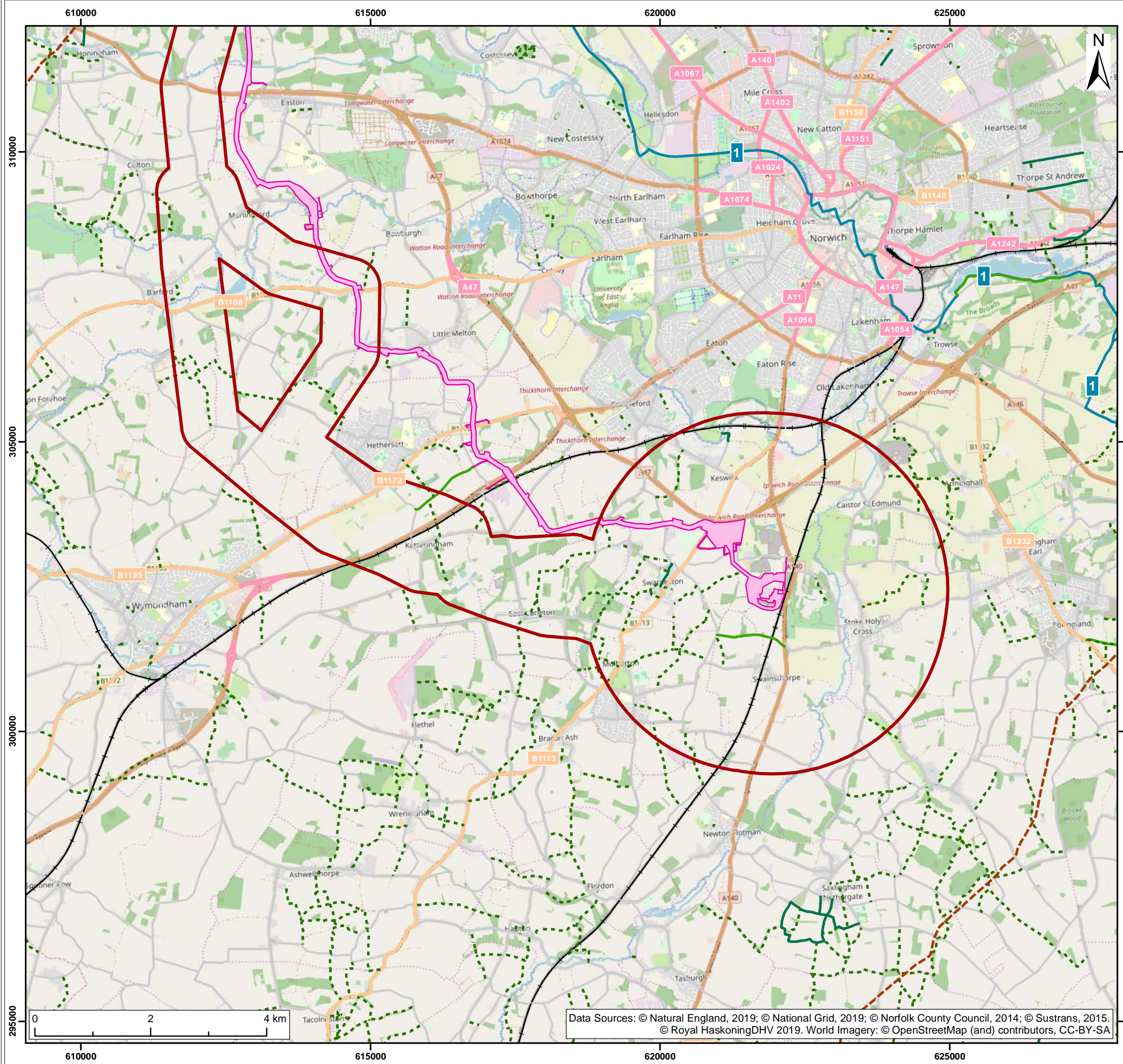

- Legend:**
- Onshore Scoping Area
  - Hornsea Project Three onshore red line boundary
  - High Pressure Gas Pipe location
  - Railway line
  - A Road
  - B Road
  - Minor Road
  - Primary Road
  - National Cycle Route
- Public Rights of Way**
- Footpath
  - Bridleway
  - Restricted byway

A1	C01	02/10/2019	Approved & accepted stage complete	LB	MW	AP
SUI	REV	DATE	DESCRIPTION	DRW	CHK	APR

Title:  
 PRoWs Urban Areas, Roads and Utilities

Figure:3.3.2	Drawing No: PB8164-RHD-ZZ-ON-DR-Z-0013	
Co-ordinate system: British National Grid	Page Size: A3	Scale: 1:65,000
Project: Dudgeon and Sheringham Shoal Offshore Wind Farm Extensions	Report: Scoping Report	



Data Sources: © Natural England, 2019; © National Grid, 2019; © Norfolk County Council, 2014; © Sustrans, 2015.  
 © Royal HaskoningDHV 2019. World Imagery: © OpenStreetMap (and) contributors, CC-BY-SA



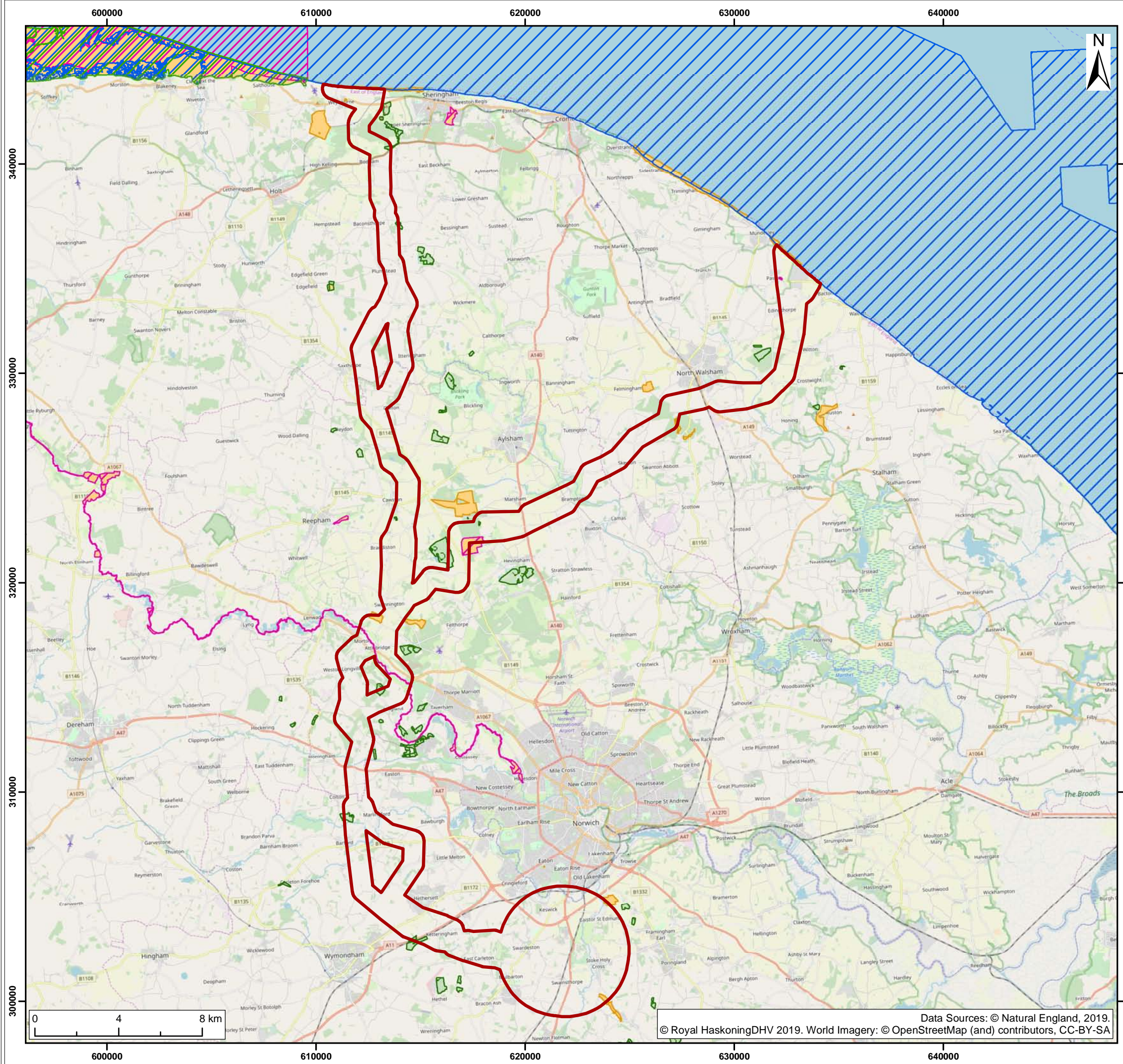

- Legend:
- Onshore Scoping Area
  - Ancient Woodland
  - Ramsar
  - Special Area of Conservation (SAC)
  - Special Protection Area (SPA)
  - Sites of Special Scientific Interest (SSSI)

A1	C01	02/10/2019	Approved & accepted stage complete	LB	MW	AP
SUI	REV	DATE	DESCRIPTION	DRW	CHK	APR

Title:  
**Nature Conservation Designations  
 within 3km of the Onshore Scoping Area**

Figure:3.4.1      Drawing No: PB8164-RHD-ZZ-ON-DR-Z-0010

Co-ordinate system: British National Grid	Page Size: A3	Scale: 1:180,000
--	------------------	---------------------

Project: <b>Dudgeon and Sheringham Shoal Offshore Wind Farm Extensions</b>	Report:  <b>Scoping Report</b>
---	--------------------------------------



Data Sources: © Natural England, 2019.  
 © Royal HaskoningDHV 2019. World Imagery: © OpenStreetMap (and) contributors, CC-BY-SA





- Legend:
- Onshore Scoping Area
  - Registered Park and Garden
  - Scheduled Monument
- Listed Building**
- Grade I
  - Grade II
  - Grade II\*

A1	C01	02/10/2019	Approved & accepted stage complete	LB	MW	AP
SUI	REV	DATE	DESCRIPTION	DRW	CHK	APR

Title:  
Designated Heritage Assets within Scoping boundary

Figure:3.5.1      Drawing No: PB8164-RHD-ZZ-ON-DR-Z-0008

Co-ordinate system: British National Grid	Page Size: A3	Scale: 1:180,000
--	------------------	---------------------

Project: Dudgeon and Sheringham Shoal Offshore Wind Farm Extensions	Report:  Scoping Report
--	-------------------------------



Data Sources: © Historic England, 2019.  
© Royal HaskoningDHV 2019. World Imagery: © OpenStreetMap (and) contributors, CC-BY-SA



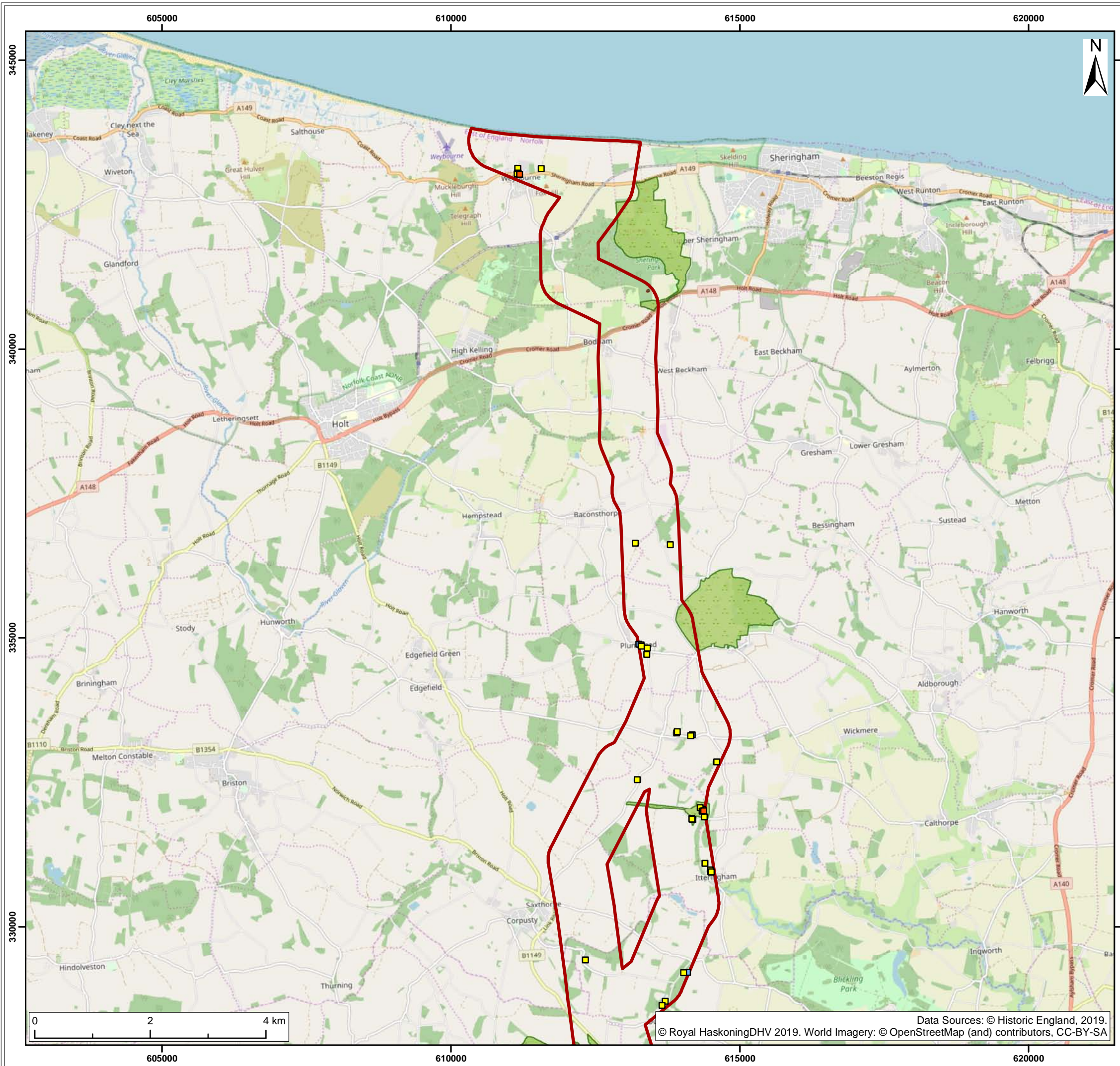

- Legend:
- Onshore Scoping Area
  - Registered Park and Garden
  - Scheduled Monument
- Listed Building**
- Grade I
  - Grade II
  - Grade II\*

A1	C01	02/10/2019	Approved & accepted stage complete	LB	MW	AP
SUI	REV	DATE	DESCRIPTION	DRW	CHK	APR

Title:  
 Designated Heritage Assets within Scoping boundary, Detailed figure (Sheet 1 of 4)

Figure: 3.5.2      Drawing No: PB8164-RHD-ZZ-ON-DR-Z-0009

Co-ordinate system: British National Grid      Page Size: A3      Scale: 1:65,000

Project: Dudgeon and Sheringham Shoal Offshore Wind Farm Extensions      Report: Scoping Report





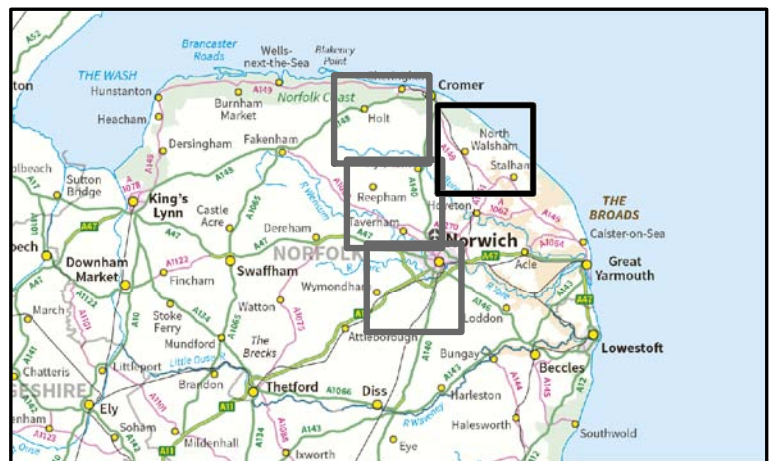

- Legend:
- Onshore Scoping Area
  - Scheduled Monument
- Listed Building
- Grade I
  - Grade II
  - Grade II\*

A1	C01	02/10/2019	Approved & accepted stage complete	LB	MW	AP
SUI	REV	DATE	DESCRIPTION	DRW	CHK	APR

Title:  
 Designated Heritage Assets within Scoping boundary, Detailed figure (Sheet 2 of 4)

Figure: 3.5.2      Drawing No: PB8164-RHD-ZZ-ON-DR-Z-0009

Co-ordinate system: British National Grid      Page Size: A3      Scale: 1:65,000

Project: Dudgeon and Sheringham Shoal Offshore Wind Farm Extensions      Report: Scoping Report





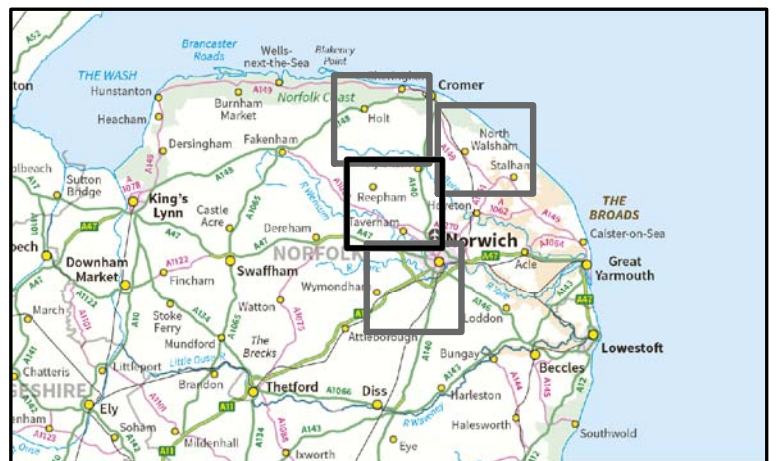
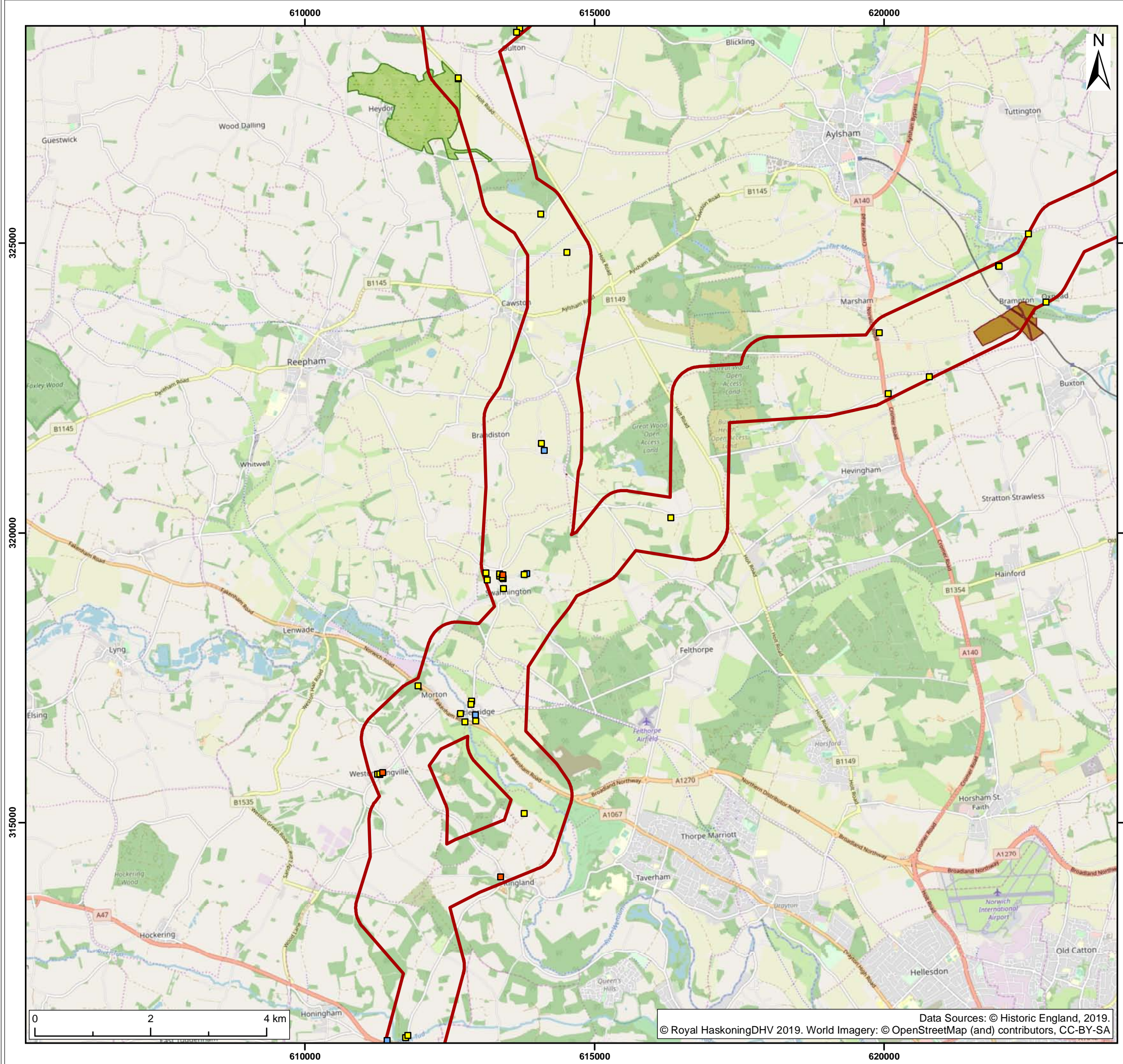

- Legend:
- Onshore Scoping Area
  - Registered Park and Garden
  - Scheduled Monument
- Listed Building**
- Grade I
  - Grade II
  - Grade II\*

A1	C01	02/10/2019	Approved & accepted stage complete	LB	MW	AP
SUI	REV	DATE	DESCRIPTION	DRW	CHK	APR

Title:  
 Designated Heritage Assets within Scoping boundary, Detailed figure (Sheet 3 of 4)

Figure:3.5.2      Drawing No: PB8164-RHD-ZZ-ON-DR-Z-0009

Co-ordinate system: British National Grid	Page Size: A3	Scale: 1:65,000
--	------------------	--------------------

Project: Dudgeon and Sheringham Shoal Offshore Wind Farm Extensions	Report: Scoping Report
--	---------------------------





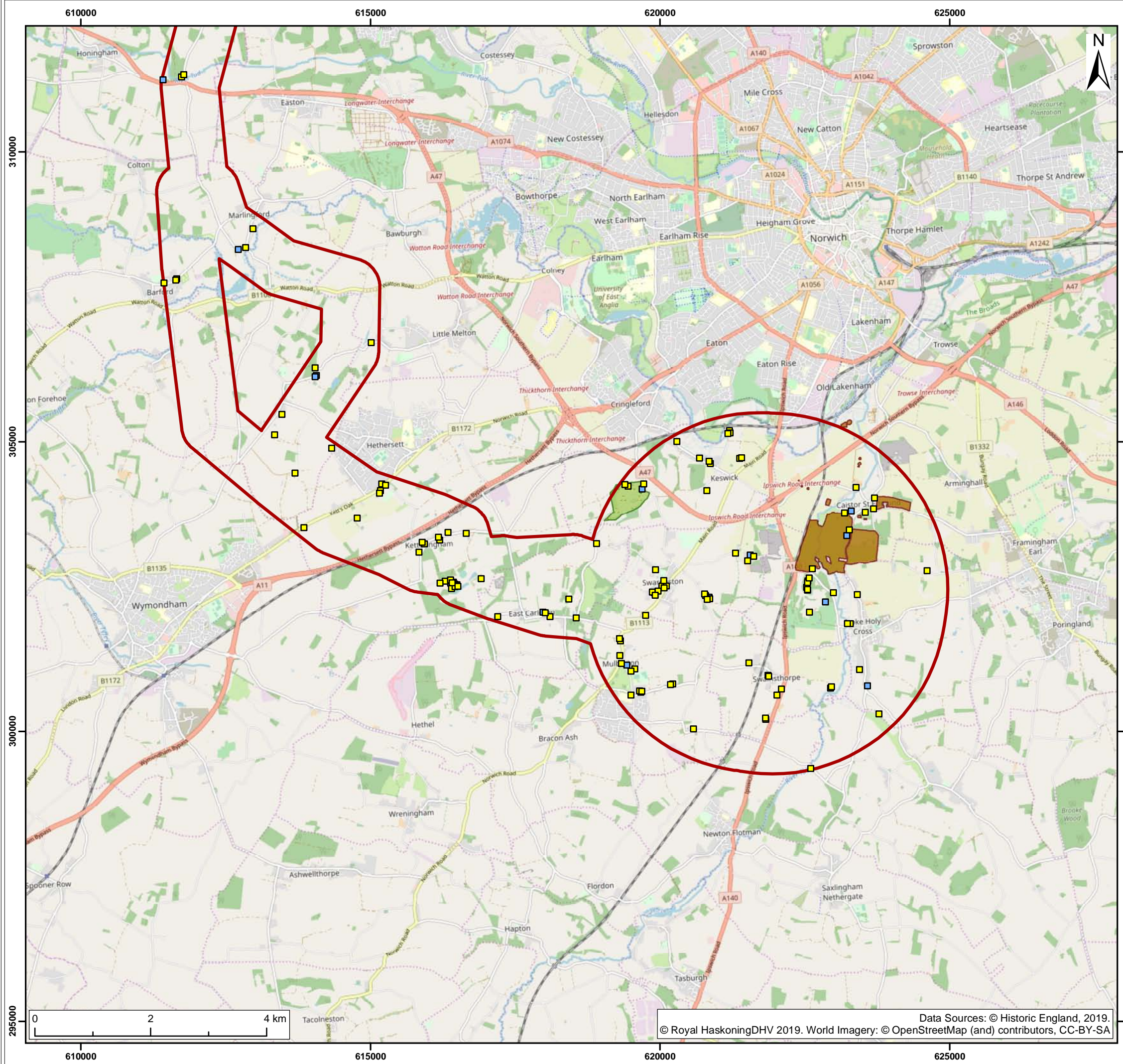

- Legend:**
- Onshore Scoping Area
  - Registered Park and Garden
  - Scheduled Monument
- Listed Building**
- Grade II
  - Grade II\*

A1	C01	02/10/2019	Approved & accepted stage complete	LB	MW	AP
SUI	REV	DATE	DESCRIPTION	DRW	CHK	APR

Title:  
 Designated Heritage Assets within Scoping boundary, Detailed figure (Sheet 4 of 4)

Figure: 3.5.2      Drawing No: PB8164-RHD-ZZ-ON-DR-Z-0009

Co-ordinate system: British National Grid	Page Size: A3	Scale: 1:65,000
--	------------------	--------------------

Project: Dudgeon and Sheringham Shoal Offshore Wind Farm Extensions	Report: Scoping Report
--	---------------------------





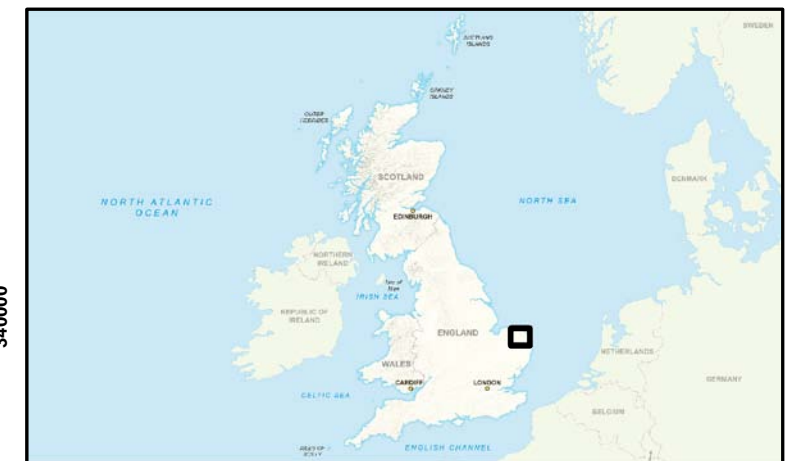
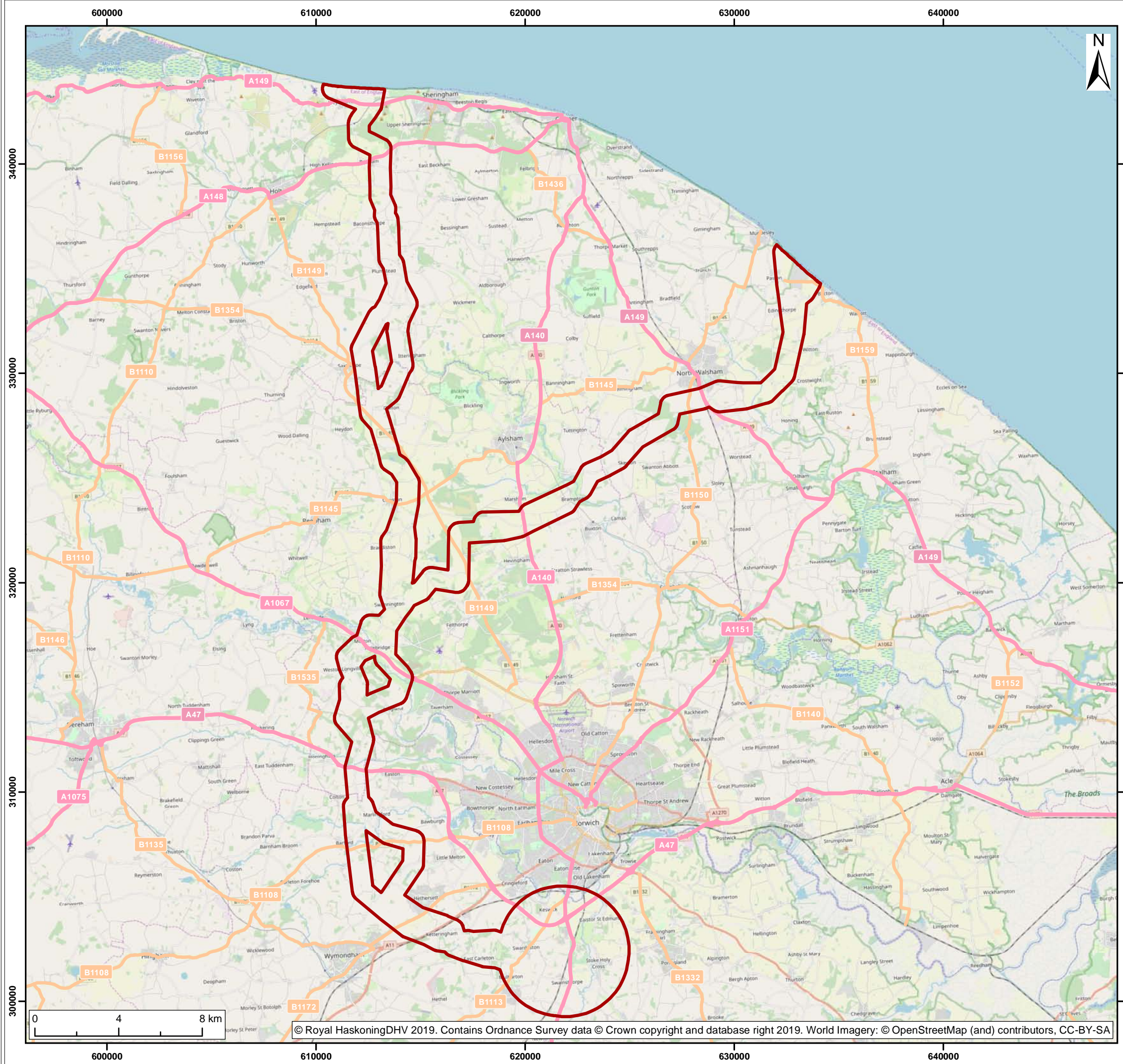

Legend:  
   Onshore Scoping Area  
 A Road  
 B Road

A1	C01	01/10/2019	Approved & accepted stage complete	LB	MW	AP
SUI	REV	DATE	DESCRIPTION	DRW	CHK	APR

Title:  
**Strategic Road Network**

Figure:3.8.1	Drawing No: PB8164-RHD-ZZ-ON-DR-Z-0020	
Co-ordinate system: British National Grid	Page Size: A3	Scale: 1:180,000
Project: Dudgeon and Sheringham Shoal Offshore Wind Farm Extensions	Report: <b>Scoping Report</b>	





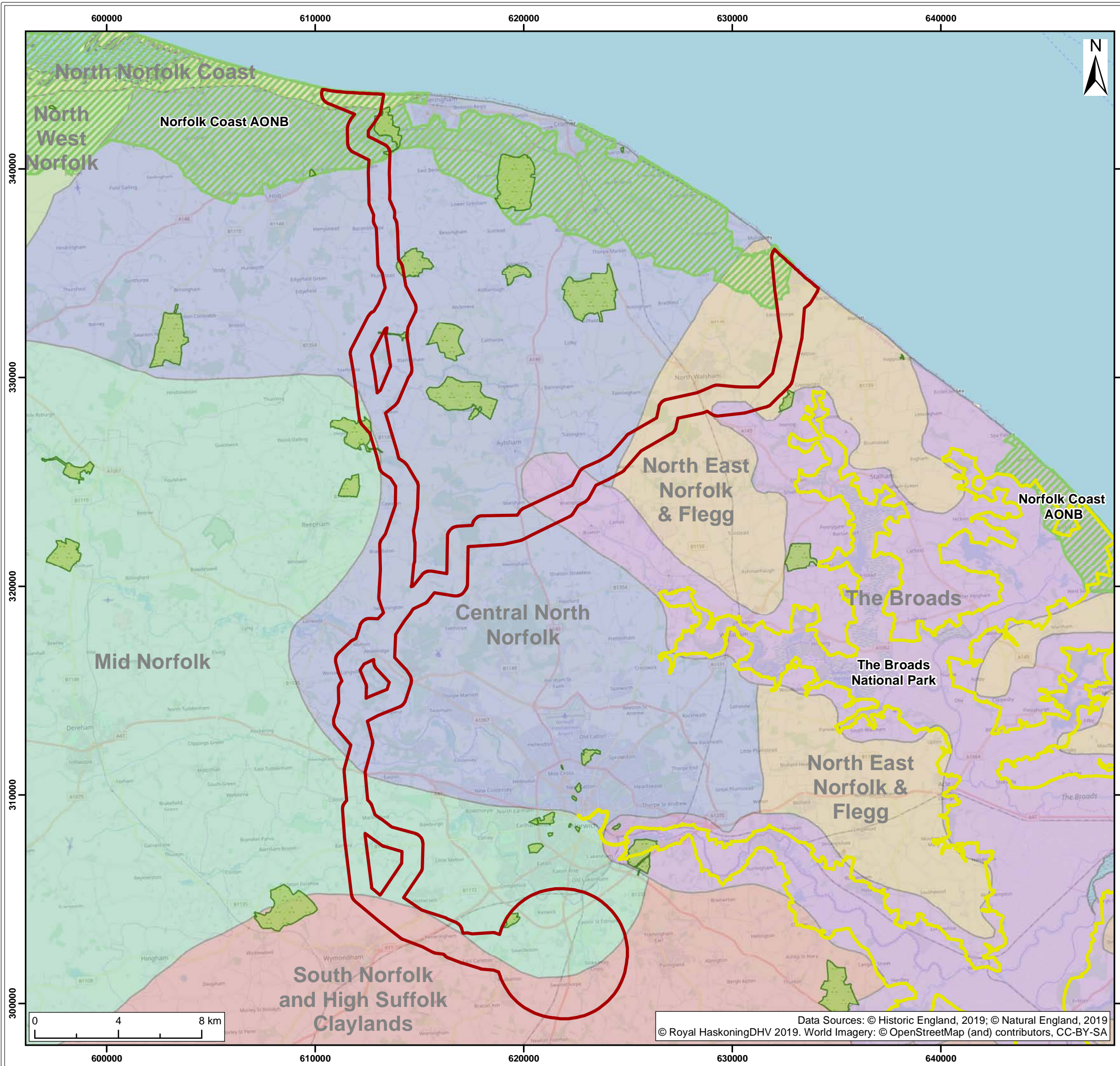

- Legend:
- Onshore Scoping Area
  - Area of Outstanding Natural Beauty (AONB)
  - National Park
  - Registered Park and Garden
- National Character Area**
- Central North Norfolk
  - Mid Norfolk
  - North East Norfolk and Flegg
  - North Norfolk Coast
  - North West Norfolk
  - South Norfolk and High Suffolk Claylands
  - Suffolk Coast and Heaths
  - The Broads

A1	C01	24/07/2019	Approved & accepted stage complete	LB	MW	AP
SUI	REV	DATE	DESCRIPTION	DRW	CHK	APR

Title:  
Landscape Designations  
(Sheet 2 of 2)

Figure: 4.1.1      Drawing No: PB8164-RHD-ZZ-ON-DR-Z-0014

Co-ordinate system: British National Grid      Page Size: A3      Scale: 1:180,000

Project:  
Dudgeon and Sheringham  
Shoal Offshore Wind Farm  
Extensions

Report:  
Scoping Report

Data Sources: © Historic England, 2019; © Natural England, 2019  
© Royal HaskoningDHV 2019. World Imagery: © OpenStreetMap (and) contributors, CC-BY-SA





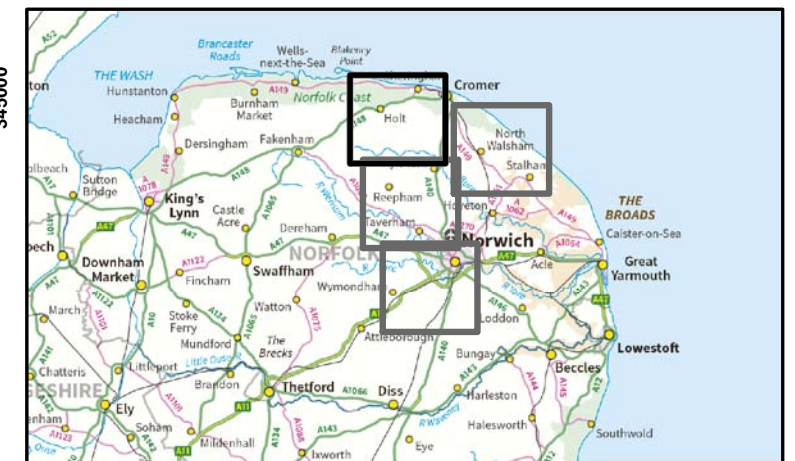
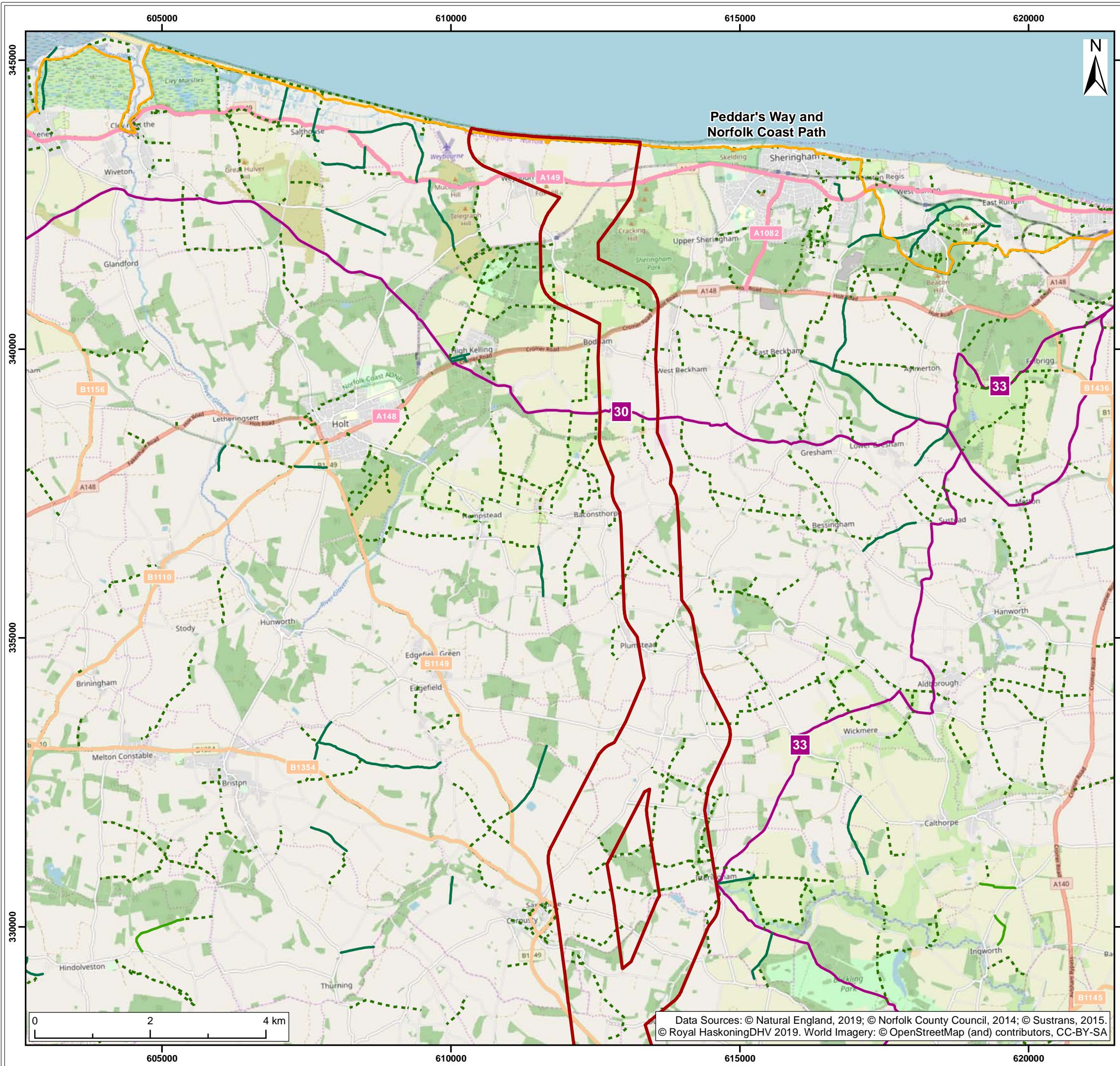

- Legend:
- Onshore Scoping
  - A Road
  - B Road
  - Regional Cycle Route
- Public Rights of Way**
- Footpath
  - Bridleway
  - Restricted byway
  - National Trails

A1	C01	02/10/2019	Approved & accepted stage complete	LB	MW	AP
SUI	REV	DATE	DESCRIPTION	DRW	CHK	APR

Title:  
Visual Receptors

Figure: 4.1.2	Drawing No: PB8164-RHD-ZZ-ON-DR-Z-0015	
Co-ordinate system: British National Grid	Page Size: A3	Scale: 1:65,000
Project: Dudgeon and Sheringham Shoal Offshore Wind Farm Extensions	Report: Scoping Report	

Data Sources: © Natural England, 2019; © Norfolk County Council, 2014; © Sustrans, 2015.  
© Royal HaskoningDHV 2019. World Imagery: © OpenStreetMap (and) contributors, CC-BY-SA





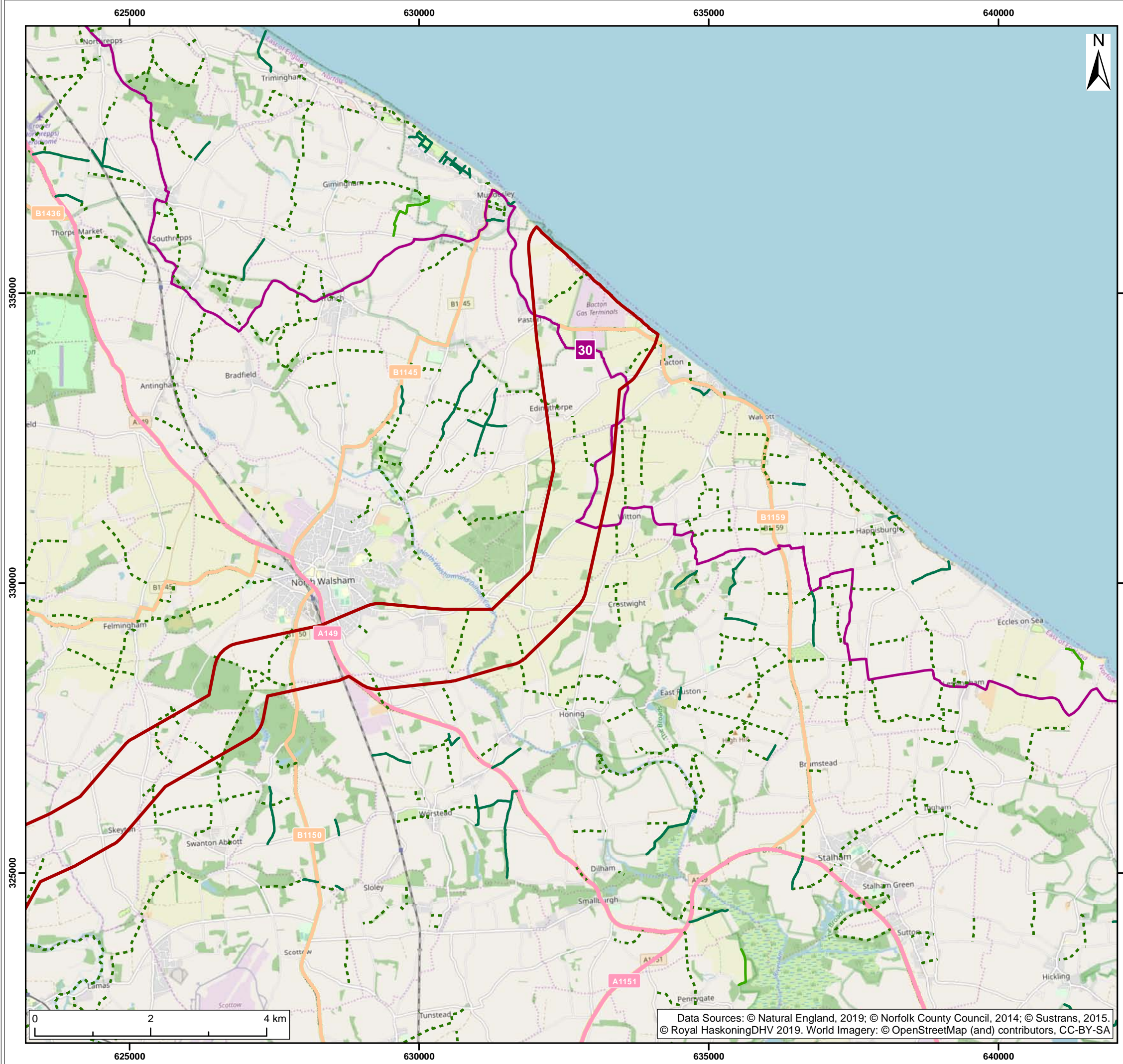

- Legend:
- Onshore Scoping
  - A Road
  - B Road
  - Regional Cycle Route
- Public Rights of Way**
- Footpath
  - Bridleway
  - Restricted byway

A1	C01	02/10/2019	Approved & accepted stage complete	LB	MW	AP
SUI	REV	DATE	DESCRIPTION	DRW	CHK	APR

Title:  
Visual Receptors

Figure: 4.1.2      Drawing No: PB8164-RHD-ZZ-ON-DR-Z-0015

Co-ordinate system: British National Grid	Page Size: A3	Scale: 1:65,000
--	------------------	--------------------

Project: Dudgeon and Sheringham Shoal Offshore Wind Farm Extensions	Report:  Scoping Report
--	-------------------------------

Data Sources: © Natural England, 2019; © Norfolk County Council, 2014; © Sustrans, 2015.  
© Royal HaskoningDHV 2019. World Imagery: © OpenStreetMap (and) contributors, CC-BY-SA





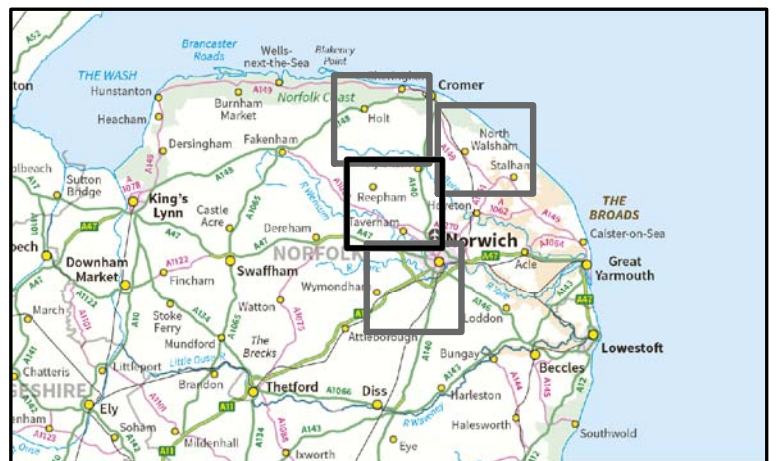
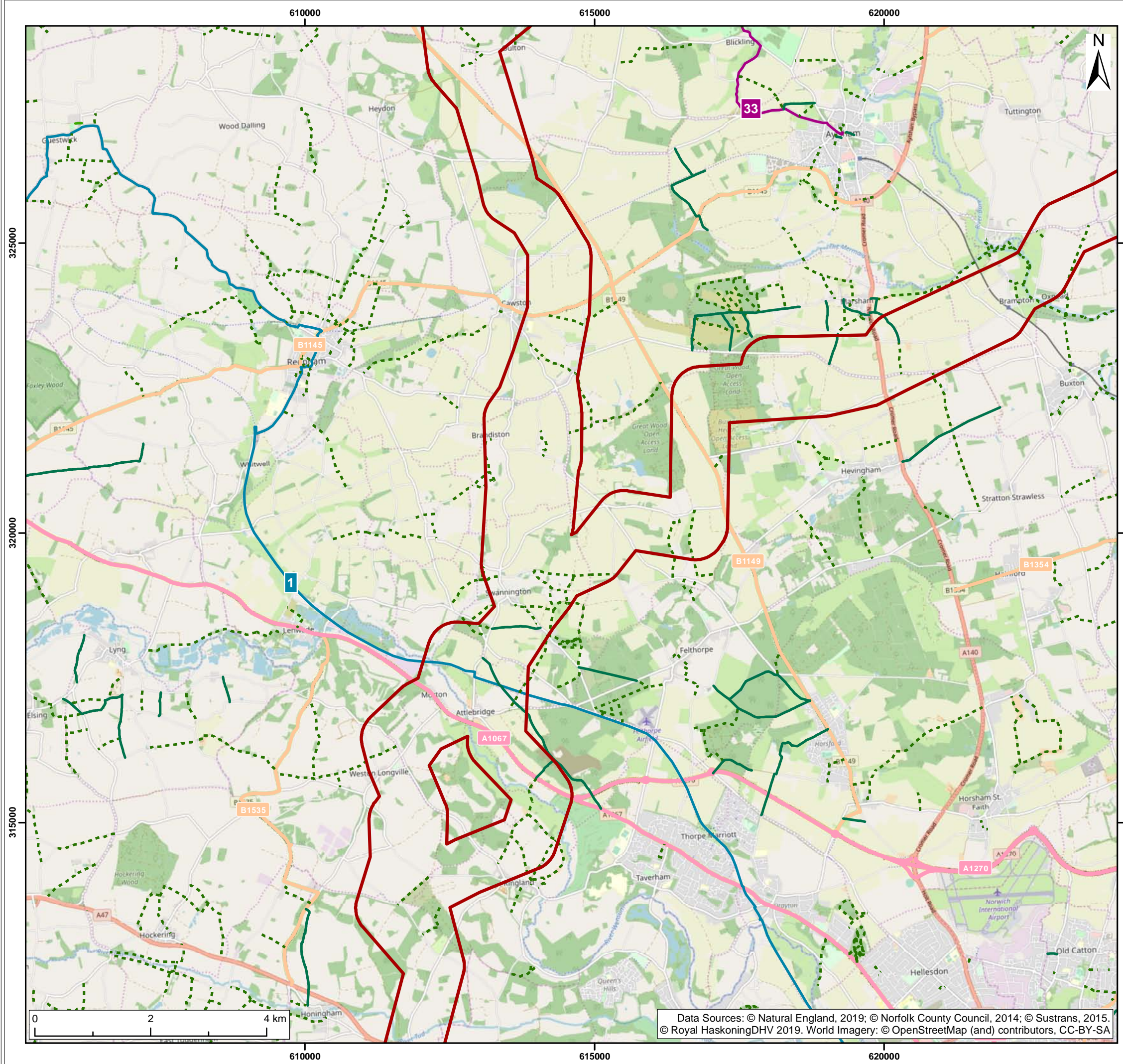

- Legend:
- Onshore Scoping
  - A Road
  - B Road
  - National Cycle Route
  - Regional Cycle Route
- Public Rights of Way**
- Footpath
  - Bridleway
  - Restricted byway

A1	C01	02/10/2019	Approved & accepted stage complete	LB	MW	AP
SUI	REV	DATE	DESCRIPTION	DRW	CHK	APR

Title:  
Visual Receptors

Figure: 4.1.2      Drawing No: PB8164-RHD-ZZ-ON-DR-Z-0015

Co-ordinate system: British National Grid	Page Size: A3	Scale: 1:65,000
--	------------------	--------------------

Project: Dudgeon and Sheringham Shoal Offshore Wind Farm Extensions	Report: Scoping Report
--	---------------------------



Data Sources: © Natural England, 2019; © Norfolk County Council, 2014; © Sustrans, 2015.  
© Royal HaskoningDHV 2019. World Imagery: © OpenStreetMap (and) contributors, CC-BY-SA



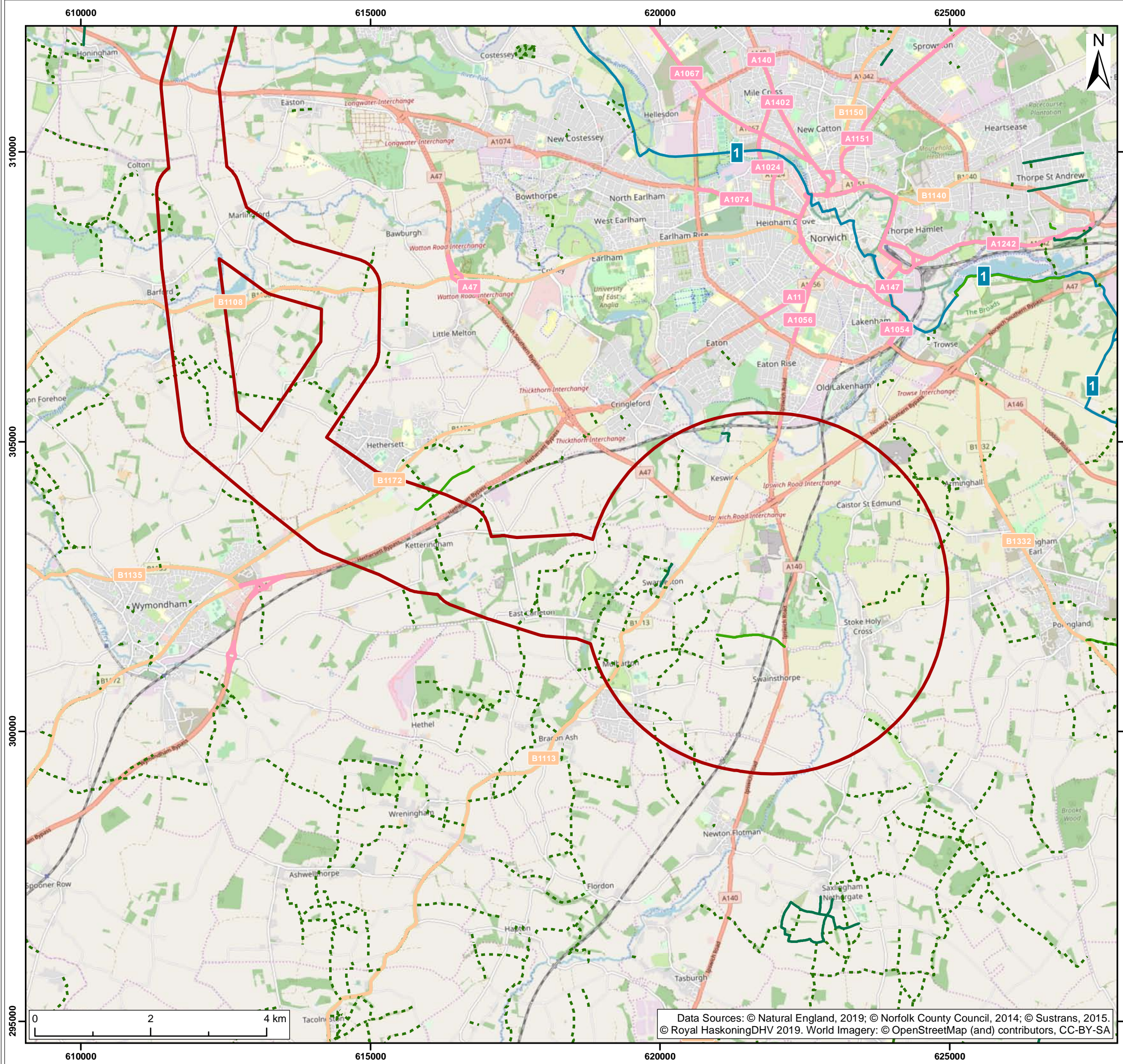

- Legend:
- Onshore Scoping
  - A Road
  - B Road
  - National Cycle Route
  - Public Rights of Way**
  - Footpath
  - Bridleway
  - Restricted byway

A1	C01	02/10/2019	Approved & accepted stage complete	LB	MW	AP
SUI	REV	DATE	DESCRIPTION	DRW	CHK	APR

Title:  
**Visual Receptors**

Figure: 4.1.2      Drawing No: PB8164-RHD-ZZ-ON-DR-Z-0015

Co-ordinate system: British National Grid      Page Size: A3      Scale: 1:65,000

Project: Dudgeon and Sheringham Shoal Offshore Wind Farm Extensions      Report: Scoping Report

Data Sources: © Natural England, 2019; © Norfolk County Council, 2014; © Sustrans, 2015. © Royal HaskoningDHV 2019. World Imagery: © OpenStreetMap (and) contributors, CC-BY-SA





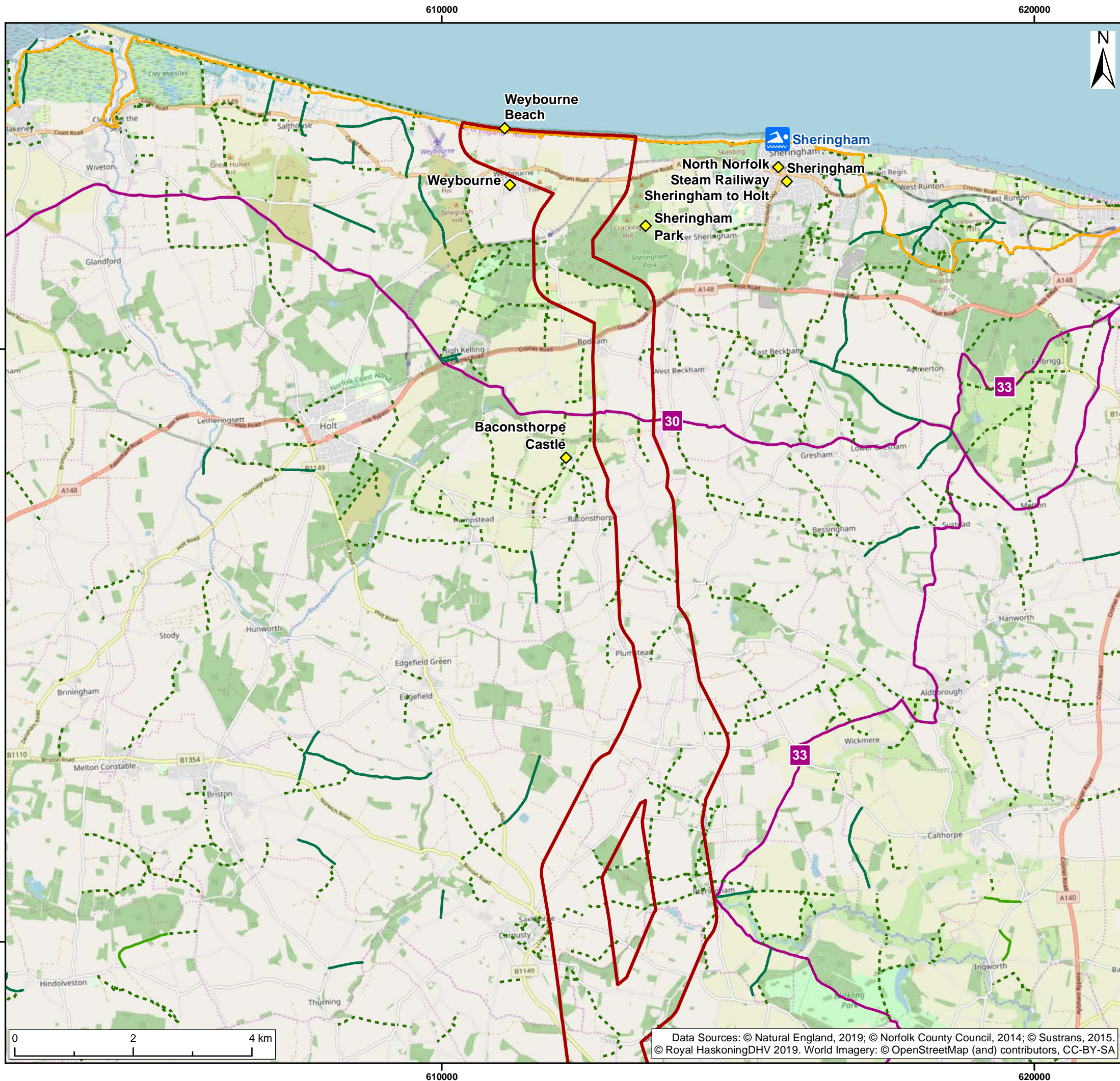

- Legend:
- Onshore Scoping Area
  - Notable Tourist Attractions**
  - ◆ Attraction Location (point locations)
  - Blue Flag Beach
  - Regional Cycle Route
  - Public Rights of Way**
  - Footpath
  - Bridleway
  - Restricted byway
  - Peddar's Way and Norfolk Coast Path

A1	C01	02/10/2019	Approved & accepted stage complete	LB	MW	AP
SUI	REV	DATE	DESCRIPTION	DRW	CHK	APR

Title:  
Notable Tourist attractions near to/in the Scoping Area

Figure: 4.4.1      Drawing No: PB8164-RHD-ZZ-ON-DR-Z-0011

Co-ordinate system: British National Grid	Page Size: A3	Scale: 1:65,000
--	------------------	--------------------

Project: Dudgeon and Sheringham Shoal Offshore Wind Farm Extensions	Report:  Scoping Report
--	-------------------------------

Data Sources: © Natural England, 2019; © Norfolk County Council, 2014; © Sustrans, 2015.  
© Royal HaskoningDHV 2019. World Imagery: © OpenStreetMap (and) contributors, CC-BY-SA





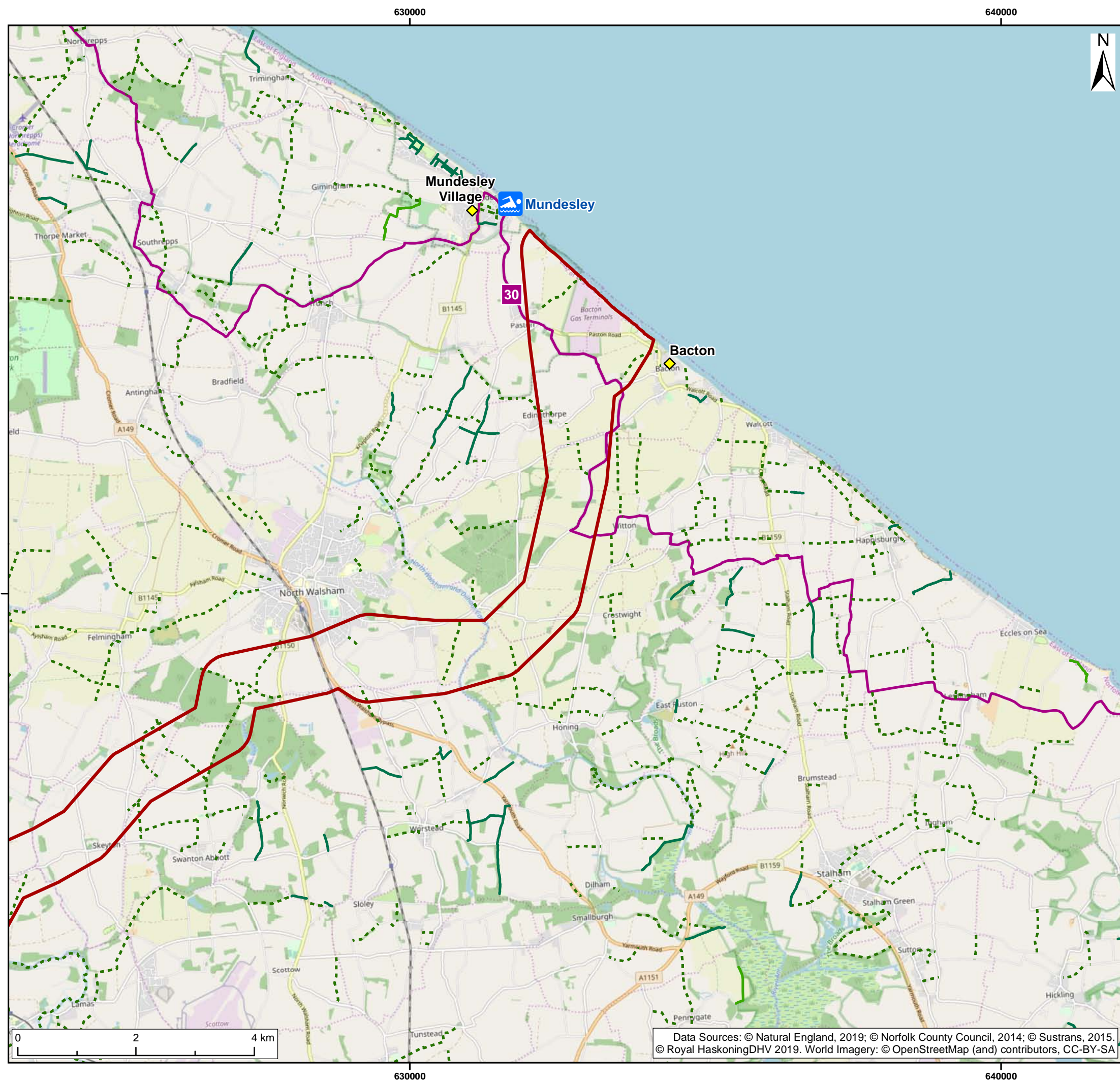

- Legend:
- Onshore Scoping Area
  - Notable Tourist Attractions**
  - ◆ Attraction Location (point locations)
  - Blue Flag Beach
  - Regional Cycle Route
  - Public Rights of Way**
  - Footpath
  - Bridleway
  - Restricted byway

A1	C01	02/10/2019	Approved & accepted stage complete	LB	MW	AP
SUI	REV	DATE	DESCRIPTION	DRW	CHK	APR

Title:  
 Notable Tourist attractions near to/in the Scoping Area

Figure: 4.4.1      Drawing No: PB8164-RHD-ZZ-ON-DR-Z-0011

Co-ordinate system: British National Grid	Page Size: A3	Scale: 1:65,000
--	------------------	--------------------

Project: Dudgeon and Sheringham Shoal Offshore Wind Farm Extensions	Report:  Scoping Report
--	-------------------------------

Data Sources: © Natural England, 2019; © Norfolk County Council, 2014; © Sustrans, 2015.  
 © Royal HaskoningDHV 2019. World Imagery: © OpenStreetMap (and) contributors, CC-BY-SA





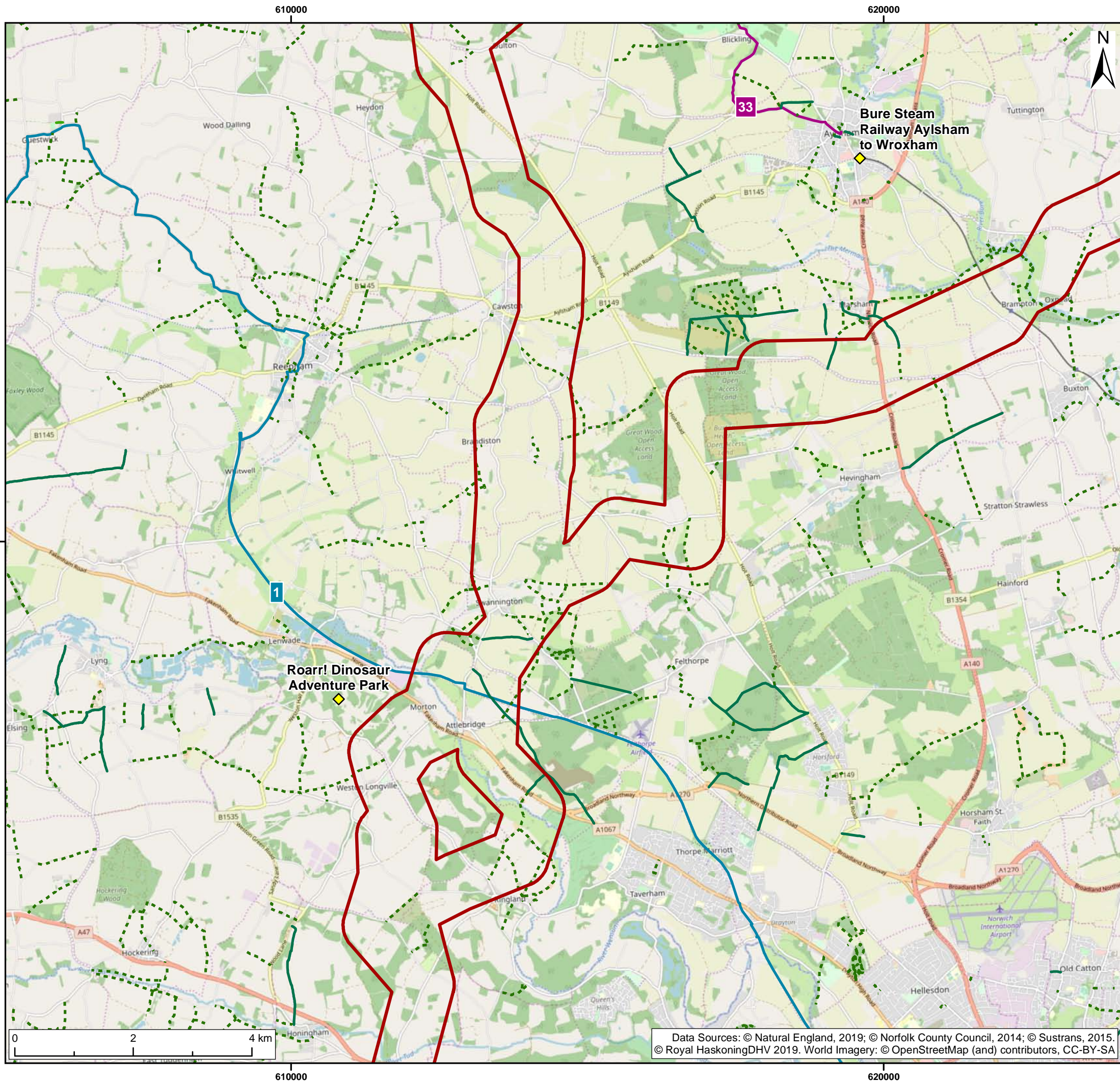

Data Sources: © Natural England, 2019; © Norfolk County Council, 2014; © Sustrans, 2015. © Royal HaskoningDHV 2019. World Imagery: © OpenStreetMap (and) contributors, CC-BY-SA

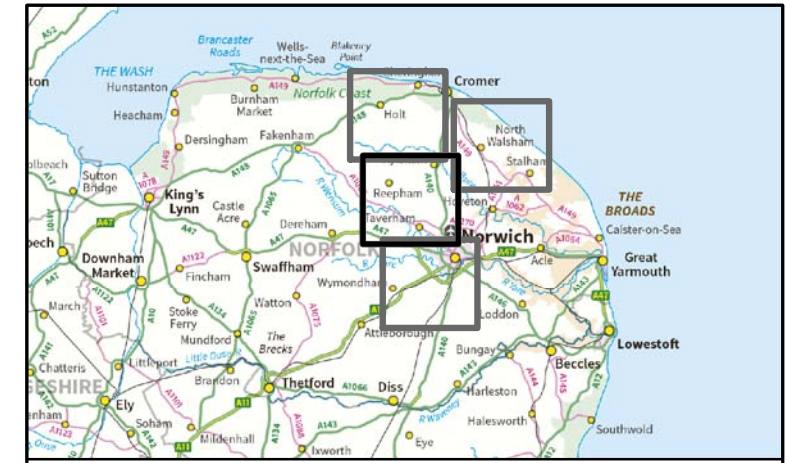

- Legend:
- Onshore Scoping Area
  - Notable Tourist Attractions**
  - ◆ Attraction Location (point locations)
  - National Cycle Route
  - Regional Cycle Route
  - Public Rights of Way**
  - Footpath
  - Bridleway
  - Restricted byway

A1	C01	02/10/2019	Approved & accepted stage complete	LB	MW	AP
SUI	REV	DATE	DESCRIPTION	DRW	CHK	APR

Title:  
Notable Tourist attractions near to/in the Scoping Area

Figure: 4.4.1	Drawing No: PB8164-RHD-ZZ-ON-DR-Z-0011	
Co-ordinate system: British National Grid	Page Size: A3	Scale: 1:65,000
Project: Dudgeon and Sheringham Shoal Offshore Wind Farm Extensions	Report: Scoping Report	





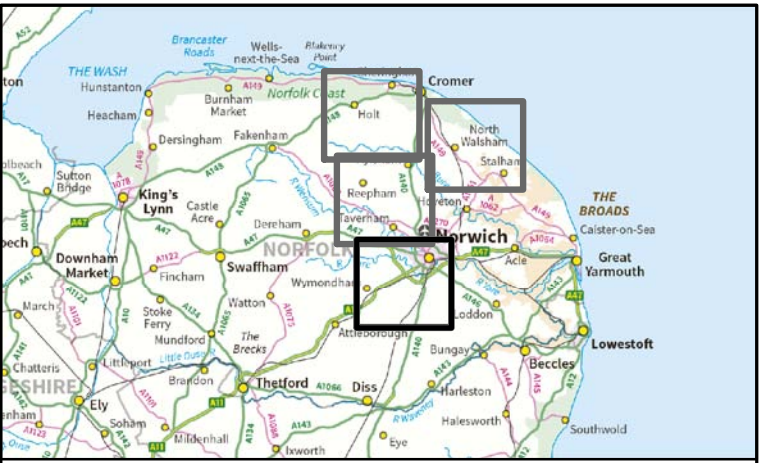
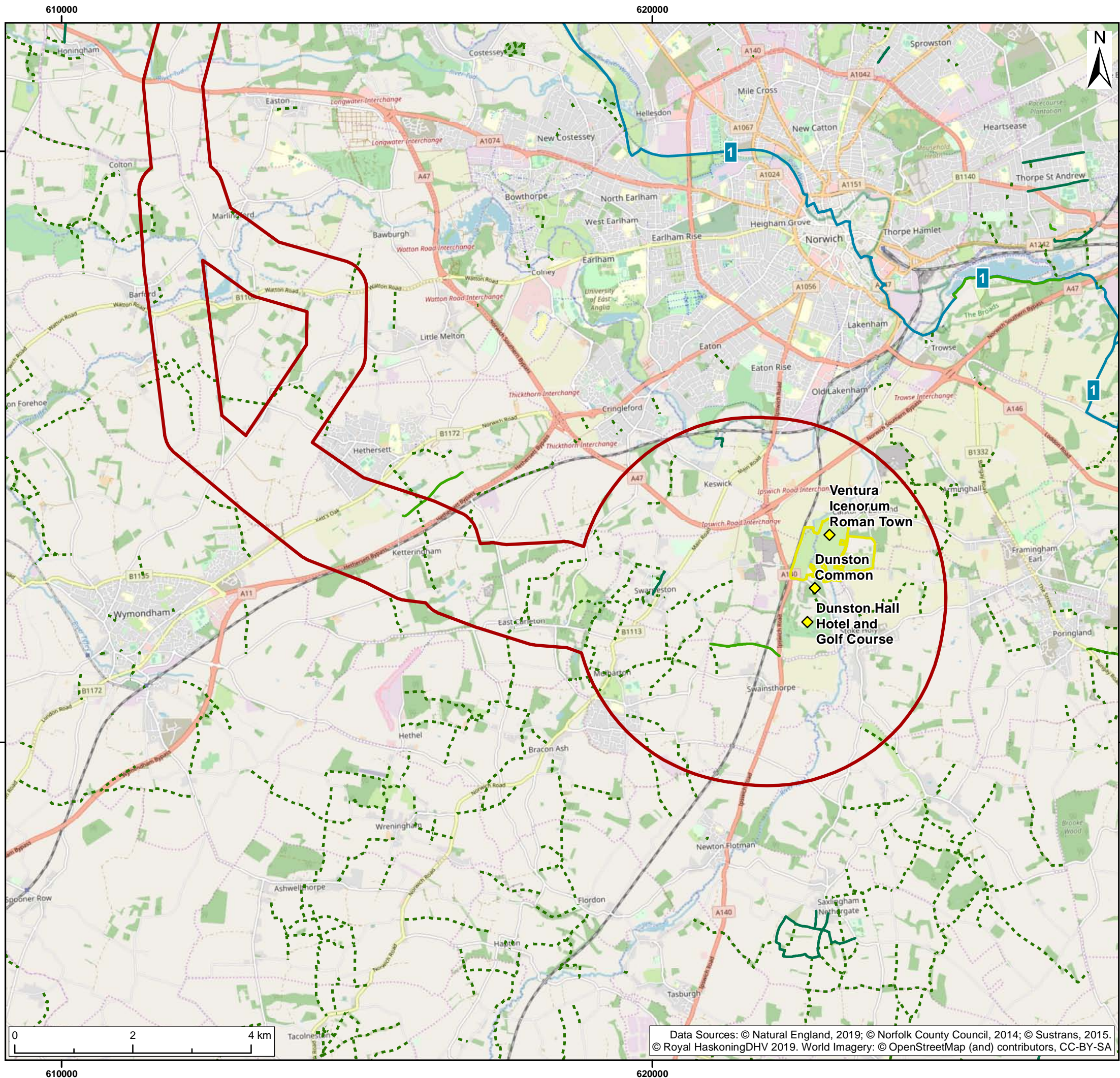

- Legend:
- Onshore Scoping Area
  - Notable Tourist Attractions**
  - ◆ Attraction Location (point locations)
  - Attraction Location (areas)
  - National Cycle Route
  - Public Rights of Way**
  - Footpath
  - - - Bridleway
  - Restricted byway

A1	C01	02/10/2019	Approved & accepted stage complete	LB	MW	AP
SUI	REV	DATE	DESCRIPTION	DRW	CHK	APR

Title:  
Notable Tourist attractions near to/in the Scoping Area

Figure: 4.4.1	Drawing No: PB8164-RHD-ZZ-ON-DR-Z-0011	
Co-ordinate system: British National Grid	Page Size: A3	Scale: 1:65,000
Project: Dudgeon and Sheringham Shoal Offshore Wind Farm Extensions	Report: Scoping Report	

Data Sources: © Natural England, 2019; © Norfolk County Council, 2014; © Sustrans, 2015. © Royal HaskoningDHV 2019. World Imagery: © OpenStreetMap (and) contributors, CC-BY-SA





